

TOSHIBA TRANSISTOR SILICON NPN EPITAXIAL TYPE (PCT PROCESS)

2SC2995

FM/AM RF, MIX, OSC, IF
HIGH FREQUENCY AMPLIFIER APPLICATIONS.

- High stability Oscillation Voltage On FM Local Oscillator.
- Recommend FM/AM RF, MIX, OSC and IF.

MAXIMUM RATINGS (Ta = 25°C)

CHARACTERISTIC	SYMBOL	RATING	UNIT
Collector-Base Voltage	V _{CB0}	40	V
Collector-Emitter Voltage	V _{CEO}	30	V
Emitter-Base Voltage	V _{EB0}	4	V
Collector Current	I _C	50	mA
Emitter Current	I _E	-50	mA
Collector Power Dissipation	P _C	200	mW
Junction Temperature	T _j	125	°C
Storage Temperature Range	T _{stg}	-55~125	°C

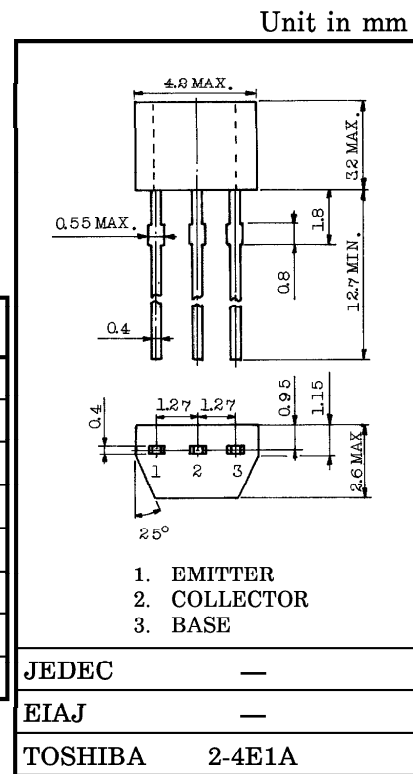

ELECTRICAL CHARACTERISTICS (Ta = 25°C)

Weight : 0.13g

CHARACTERISTIC	SYMBOL	TEST CONDITION	MIN.	TYP.	MAX.	UNIT
Collector Cut-off Current	I _{CB0}	V _{CB} = 40V, I _E = 0	—	—	0.1	μA
Emitter Cut-off Current	I _{EB0}	V _{EB} = 4V, I _C = 0	—	—	0.5	μA
DC Current Gain	h _{FE} (Note)	V _{CE} = 6V, I _C = 1mA	40	—	240	—
Reverse Transfer Capacitance	C _{re}	V _{CE} = 6V, f = 1MHz	—	0.9	1.3	pF
Transition Frequency	f _T	V _{CE} = 6V, I _E = -1mA	150	350	—	MHz
Collector-Base Time Constant	C _{c-rbb'}	V _{CE} = 6V, I _E = -1mA, f = 30MHz	—	15	30	ps
Noise Figure	NF	V _{CC} = 6V, I _E = -1mA, f = 100MHz (Fig.1)	—	4.0	—	dB
Power Gain	G _{pe}		—	15	—	
Oscillation Output Voltage	V _{OSC}	V _{CC} = 6V, f = 100MHz (Fig.2)	—	150	—	mV

Note : h_{FE} Classification R : 40~80 O : 70~140 Y : 120~240

961001EAA2

- TOSHIBA is continually working to improve the quality and the reliability of its products. Nevertheless, semiconductor devices in general can malfunction or fail due to their inherent electrical sensitivity and vulnerability to physical stress. It is the responsibility of the buyer, when utilizing TOSHIBA products, to observe standards of safety, and to avoid situations in which a malfunction or failure of a TOSHIBA product could cause loss of human life, bodily injury or damage to property. In developing your designs, please ensure that TOSHIBA products are used within specified operating ranges as set forth in the most recent products specifications. Also, please keep in mind the precautions and conditions set forth in the TOSHIBA Semiconductor Reliability Handbook.
- The information contained herein is presented only as a guide for the applications of our products. No responsibility is assumed by TOSHIBA CORPORATION for any infringements of intellectual property or other rights of the third parties which may result from its use. No license is granted by implication or otherwise under any intellectual property or other rights of TOSHIBA CORPORATION or others.
- The information contained herein is subject to change without notice.

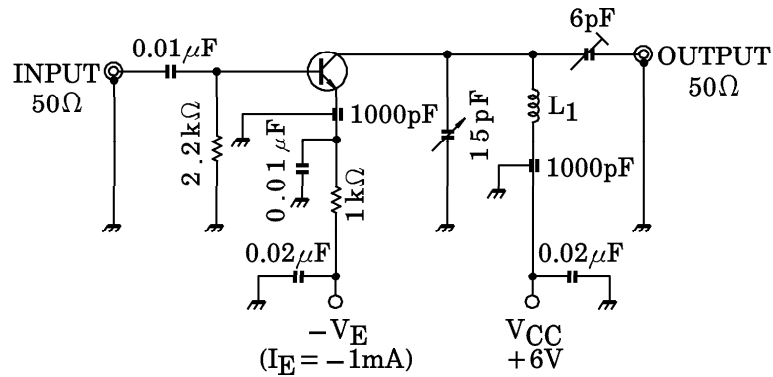

L₁ : 0.8mmφ SILVER PLATED COPPER WIRE, 4T, 10ID, 8 LENGTH

Fig.1 NF, G_{pe} TEST CIRCUIT

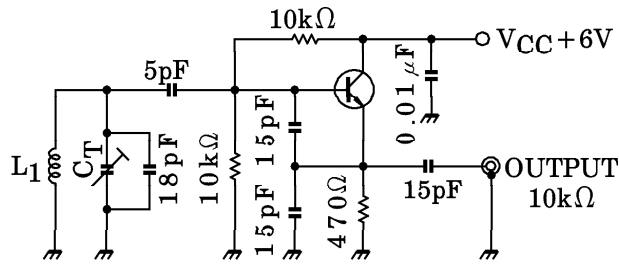

L₁ : 0.8mmφ SILVER PLATED COPPER WIRE, 4T, 10ID, 8 LENGTH

Fig.2 V_{OSC} TEST CIRCUIT

STATIC CHARACTERISTICS

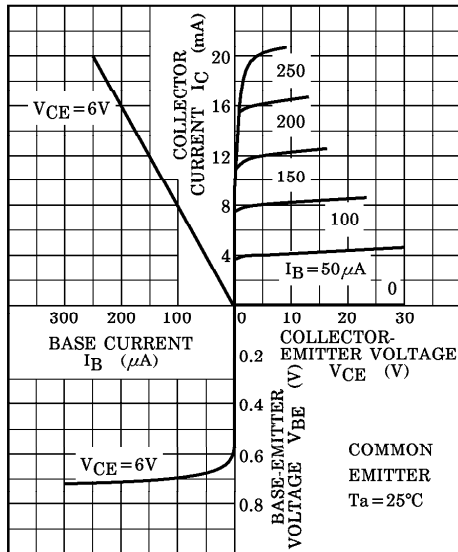

$h_{FE} - I_C$

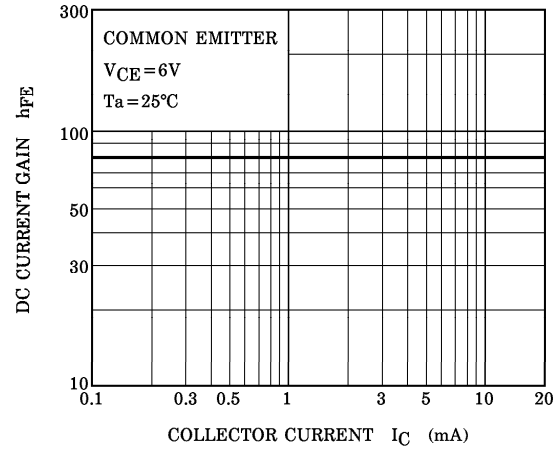

$C_{ie}, g_{ie} - I_E$

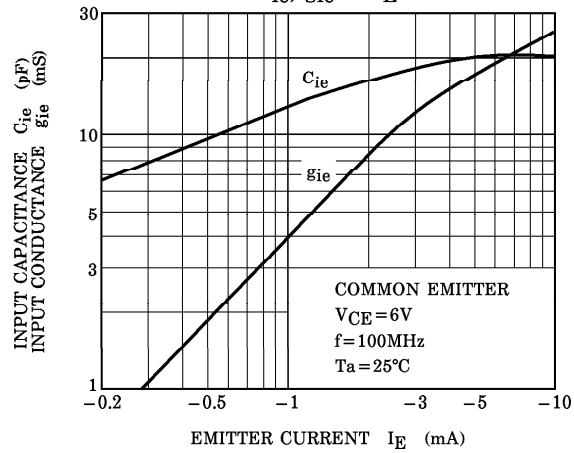

$C_{oe}, g_{oe} - I_E$

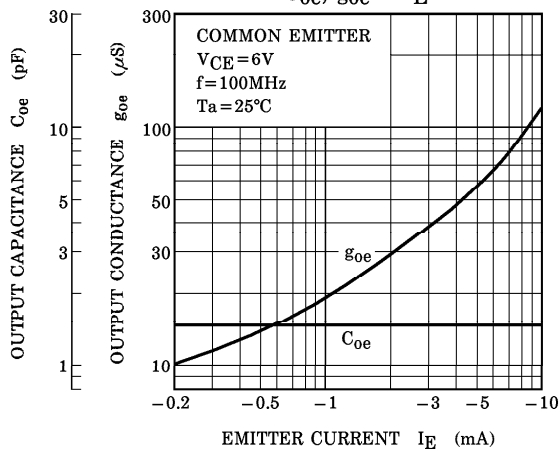

$|Y_{re}|, \theta_{re} - I_E$

