



Mini Jumper 5.08mm

Specifications

Current Rate: 7 AMP
 Insulation Resistance: 1000MΩ Min.
 Contact Resistance: 20mΩ Max.
 Dielectric Voltage: 1000V AC for one minute
 Operation Temperature: -40°C to +105°C

Material

Insulator: Polyester, UL 94V-0
 Standard: LCP
 Terminal: Copper Alloy
 Plating: Gold Plated

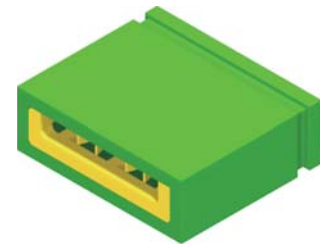
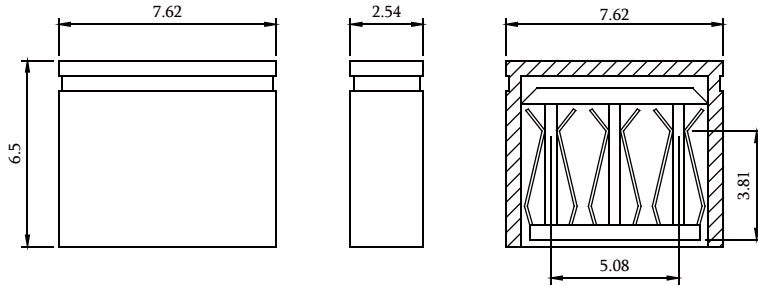

A Type

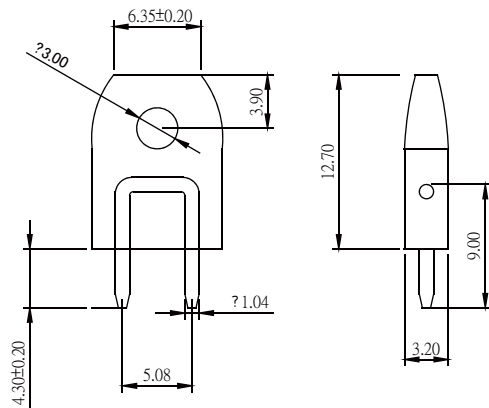

F Type

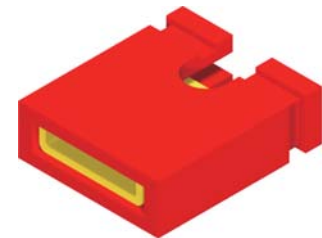
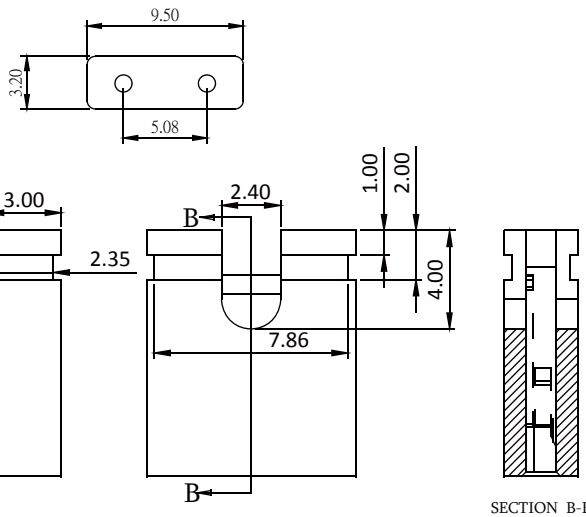

I Type

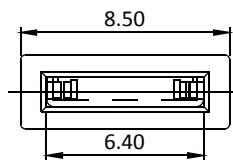

Female Header 5.08mm



RoHS

ORDER INFORMATION

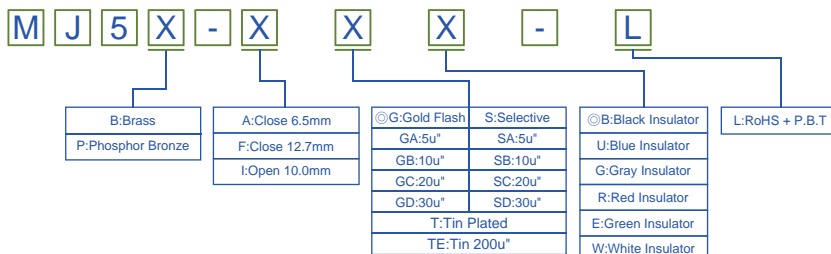

©: Standard Recommended

CONNECTORS MANUFACTURE