



HIGH GAIN, HIGH IP3

# Monolithic Amplifier

## GVA-63+

50Ω 0.01 to 6 GHz

### THE BIG DEAL

- Gain, 21 dB typ. at 0.8 GHz
- Flat Gain, ±1.7, 50 to 4000 MHz
- High Pout, P1dB 19.0 dBm typ. at 0.8 GHz
- High IP3, 35 dBm typ. at at 0.8 GHz
- Excellent ESD protection, Class 1C for HBM
- Broadband High Dynamic Range without external Matching Components
- May be used as a replacement to RFMD SBB5089Z<sup>a,b</sup>

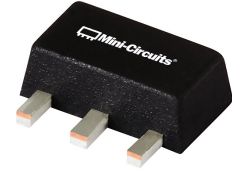

Generic photo used for illustration purposes only

CASE STYLE: DF782

**+RoHS Compliant**

The +Suffix identifies RoHS Compliance. See our web site for RoHS Compliance methodologies and qualifications

**FREE X-PARAMETERS\***

### APPLICATIONS

- Base station infrastructure
- Portable Wireless
- CATV & DBS
- MMDS & Wireless LAN
- LTE

### PRODUCT OVERVIEW

GVA-63+ (RoHS compliant) is an wideband amplifier fabricated using InGap HBT technology and offers high gain over a broad frequency range and with high IP3. In addition, the GVA-63+, has good input and output return loss over a broad frequency range without the need for external matching components and has demonstrated excellent reliability. It has repeatable performance from lot to lot and is enclosed in a SOT-89 package for very good thermal performance.

### KEY FEATURES

Feature	Advantages
Broad Band: 0.01 to 6.0 GHz	Broadband covering primary wireless communications bands: Cellular, PCS, LTE, WiMAX
Flat gain	High gain reduces number of gain stages, at lower real estate, component count and cost. ±1.7 dB from 50 MHz to 3 GHz
High IP3 Versus DC power Consumption 34 dBm typical at 0.05 GHz 35 dBm typical at 0.8 GHz	The GVA-63+ matches industry leading IP3 performance relative to device size and power consumption. The combination of the design and InGap HBT Structure provides enhanced linearity over a broad frequency range as evidence in the IP3 being typically 16 dB above the P 1dB point to 0.8 GHz. This feature makes this amplifier ideal for use in: <ul style="list-style-type: none"> <li>• Driver amplifiers for complex waveform up converter paths</li> <li>• Drivers in linearized transmit systems</li> </ul>
No External Matching Components Required	GVA-63+ provides Input and Output Return Loss of 12-25 dB up to 6 GHz without the need for any external matching components

\*X-parameters is a registered trademark of Agilent Technologies, Inc. The X-parameters format and underlying equations are open and documented.

For more information, refer to X-parameters Open Documentation, Trademark Usage & Partnerships

A. Suitability for model replacement within a particular system must be determined by and is solely the responsibility of the customer based on, among other things, electrical performance criteria, stimulus conditions, application, compatibility with other components and environmental conditions and stresses.

B. The RFMD SBB-4089Z part number is used for identification and comparison purposes only.





HIGH GAIN, HIGH IP3

# Monolithic Amplifier

GVA-63+

Mini-Circuits

## ELECTRICAL SPECIFICATIONS<sup>1,2</sup> AT 25°C, UNLESS NOTED

Parameter	Condition (GHz)	Min.	Typ.	Max.	Units
Frequency Range <sup>2</sup>		0.01		6	GHz
Gain	0.05	—	21.9	—	dB
	0.8	19.0	21.1	—	
	2.0	—	19.9	—	
	3.0	—	18.5	—	
	4.0	—	17.3	—	
	6.0	—	15.9	—	
Gain Flatness	0.05 - 3.0		±1.7		dB
	0.7 - 2.6		±1.3		
Input Return Loss	0.05	—	17.6	—	dB
	0.8	14.0	19.7	—	
	2.0	—	25.0	—	
	3.0	—	25.8	—	
	4.0	—	20.0	—	
	6.0	—	12.0	—	
Output Return Loss	0.05	—	14.5	—	dB
	0.8	14.0	20.6	—	
	2.0	—	16.6	—	
	3.0	—	16.5	—	
	4.0	—	17.1	—	
	6.0	—	13.8	—	
Reverse Isolation	2.0		23.7		dB
Output Power at 1dB Compression	0.05	—	18.7	—	dBm
	0.8	17.0	18.9	—	
	2.0	—	18.6	—	
	3.0	—	16.9	—	
	4.0	—	15.7	—	
	6.0	—	11.8	—	
Output IP3	0.05		33.5		dB
	0.8		34.8		
	2.0		32.2		
	3.0		28.6		
	4.0		26.6		
	6.0		25.0		
Noise Figure	0.05		3.6		dB
	0.8		3.8		
	2.0		3.7		
	3.0		3.7		
	4.0		4.0		
	6.0		4.6		
Device Operating Voltage		4.8	5.0	5.2	V
Device Operating Current		58	69	78	mA
Device Current Variation vs. Temperature <sup>3</sup>			61		µA/°C
Device Current Variation vs. Voltage			0.040		mA/mV
Thermal Resistance, junction-to-ground lead			91		°C/W

<sup>(1)</sup> Measured on Mini-Circuits Characterization test board TB-313. See Characterization Test Circuit (Fig. 1)

<sup>(2)</sup> Low Frequency cut-off determined by external coupling capacitors and external bias choke.

<sup>(3)</sup> Current at 85°C – Current at -45°C/130





HIGH GAIN, HIGH IP3

# Monolithic Amplifier

GVA-63+

## MAXIMUM RATINGS

Parameter	Ratings
Operating Temperature (ground lead)	-40°C to 85°C
Storage Temperature	-65°C to 150°C
Operating Current at 5V	100 mA
Power Dissipation	0.5 W
Input Power (CW)	13 dBm
DC Voltage on Pin 3	5.7 V

Permanent damage may occur if any of these limits are exceeded.  
 Electrical maximum ratings are not intended for continuous normal operation.  
 For continuous operation, do not exceed 5.2V device voltage.

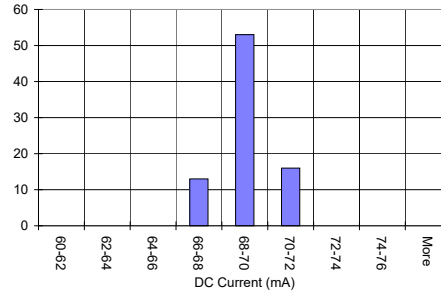

## SIMPLIFIED SCHEMATIC AND PIN DESCRIPTION

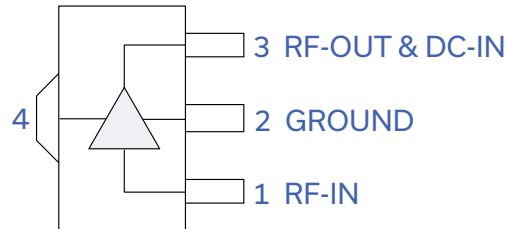
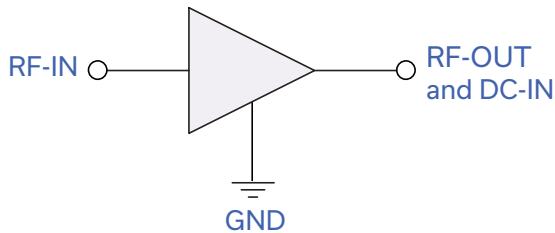

Function	Pin Number	Description
RF IN	1	RF input pin. This pin requires the use of an external DC blocking capacitor chosen for the frequency of operation.
RF-OUT and DC-IN	3	RF output and bias pin. DC voltage is present on this pin; therefore a DC blocking capacitor is necessary for proper operation. An RF choke is needed to feed DC bias without loss of RF signal due to the bias connection, as shown in "Recommended Application Circuit", Fig. 2
GND	2,4	Connections to ground. Use via holes as shown in "Suggested Layout for PCB Design" to reduce ground path inductance for best performance.

A. Suitability for model replacement within a particular system must be determined by and is solely the responsibility of the customer based on, among other things, electrical performance criteria, stimulus conditions, application, compatibility with other components and environmental conditions and stresses.  
 B. The RFMD SBB4089Z part number is used for identification and comparison purposes only.



HIGH GAIN, HIGH IP3

# Monolithic Amplifier

GVA-63+

## CHARACTERIZATION TEST CIRCUIT

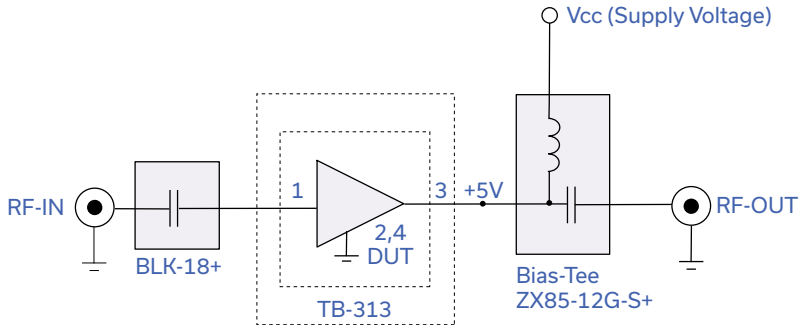

Fig 1. Block Diagram of Test Circuit used for characterization. (DUT soldered on Mini-Circuits Characterization test board TB-313)

Gain, Return loss, Output power at 1dB compression (P1 dB), output IP3 (OIP3) and noise figure measured using Agilent's N5242A PNA-X microwave network analyzer.

Conditions:

1. Gain and Return loss: Pin= -25dBm
2. Output IP3 (OIP3): Two tones, spaced 1 MHz apart, 0 dBm/tone at output.

## RECOMMENDED APPLICATION CIRCUIT

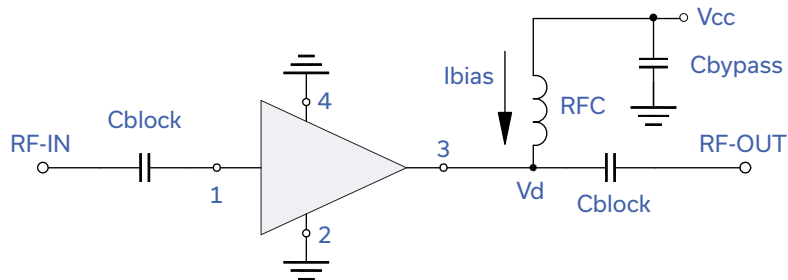
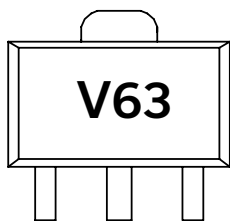

Fig 2. Test Board includes case, connectors, and components soldered to PCB

## PRODUCT MARKING



Marking may contain other features or characters for internal lot control



HIGH GAIN, HIGH IP3

# Monolithic Amplifier

GVA-63+

Mini-Circuits

ADDITIONAL DETAILED TECHNICAL INFORMATION IS AVAILABLE ON OUR DASH BOARD. TO ACCESS [CLICK HERE](#)

Performance Data	Data Table
	Swept Graphs
	S-Parameter (S2P Files) Data Set (.zip file)
Case Style	DF782 (SOT 89) Plastic package, exposed paddle lead finish: Matte-tin
Tape & Reel Standard quantities available on reel	F55 7" reels with 20, 50, 100, 200, 500 or 1K devices
Suggested Layout for PCB Design	PL-255
Evaluation Board	TB-410-63+
Environmental Ratings	ENV08T1

## ESD RATING

Human Body Model (HBM): Class 1C (1000 to <2000V) in accordance with ANSI/ESD STM 5.1 - 2001

Machine Model (MM): Class M2 (100 to <200V) in accordance with ANSI/ESD STM5.2-1999

## MSL RATING

Moisture Sensitivity: MSL1 in accordance with IPC/JEDEC J-STD-020D

## MSL TEST FLOW CHART

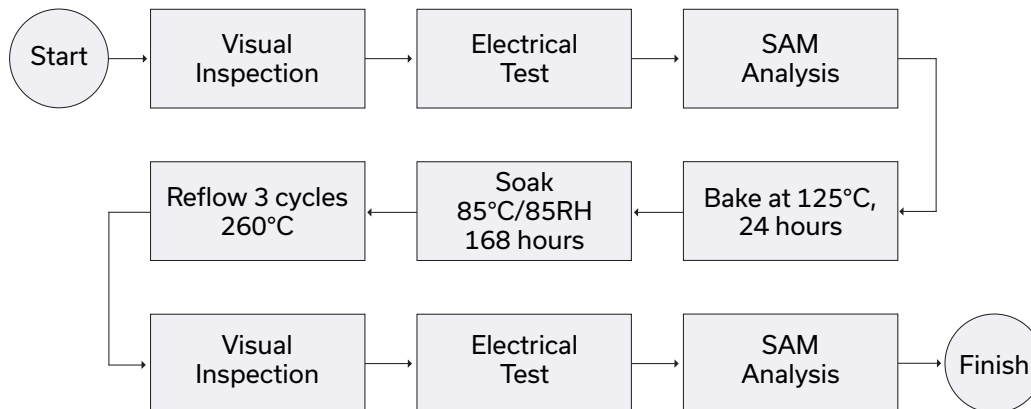

- NOTES**
- A. Performance and quality attributes and conditions not expressly stated in this specification document are intended to be excluded and do not form a part of this specification document.
  - B. Electrical specifications and performance data contained in this specification document are based on Mini-Circuit's applicable established test performance criteria and measurement instructions.
  - C. The parts covered by this specification document are subject to Mini-Circuits standard limited warranty and terms and conditions (collectively, "Standard Terms"); Purchasers of this part are entitled to the rights and benefits contained therein. For a full statement of the standard. Terms and the exclusive rights and remedies thereunder, please visit Mini-Circuits' website at [www.minicircuits.com/MCLStore/terms.jsp](http://www.minicircuits.com/MCLStore/terms.jsp)



*Typical Performance Data*

**NOTE: Use PDF Bookmarks to view DATA at required conditions**

**Definitions:**

Input Return Loss = -S11 (dB)

Gain(Power Gain) = S21 (dB)

Reverse Isolation = -S12 (dB)

Output Return Loss = -S22 (dB)

TEST CONDITIONS: Vd = 5V, Id = 68.06 mA @ Temperature = +25degC

FREQ	Gain	Isolation	Input Return Loss	Output Return Loss	Stability		IP-3 Output	1dB Comp. Output	Noise Figure
					K	Measure			
(MHz)	(dB)	(dB)	(dB)	(dB)	K	Measure	(dBm)	(dBm)	(dB)
10.0	24.42	29.01	11.09	6.34	0.90	0.48	---	18.33	2.95
30.0	22.57	25.25	15.43	11.29	0.94	0.47	37.02	19.32	3.58
50.0	21.94	24.74	17.62	14.64	0.99	0.49	33.49	18.98	3.63
100.0	21.53	24.49	19.62	18.89	1.03	0.51	34.55	19.02	3.65
200.0	21.39	24.44	20.24	21.47	1.04	0.52	34.60	18.70	3.55
300.0	21.34	24.41	20.26	22.17	1.05	0.52	35.01	18.71	3.78
400.0	21.30	24.41	20.20	22.48	1.05	0.52	34.84	18.91	3.82
500.0	21.26	24.36	20.00	22.69	1.05	0.52	34.47	18.88	3.80
600.0	21.21	24.35	19.86	22.74	1.06	0.52	35.35	18.98	3.80
700.0	21.16	24.28	19.73	22.58	1.06	0.51	34.90	19.12	3.75
800.0	21.10	24.28	19.66	22.43	1.06	0.52	35.01	19.12	3.76
1000.0	20.96	24.22	19.65	21.67	1.06	0.52	34.07	19.12	3.76
1100.0	20.89	24.10	19.76	21.12	1.06	0.52	34.32	19.21	3.73
1200.0	20.80	24.08	19.92	20.44	1.07	0.52	35.07	19.37	3.74
1300.0	20.71	24.01	20.17	19.90	1.07	0.52	34.44	19.30	3.71
1400.0	20.61	23.97	20.48	19.27	1.07	0.52	33.70	19.32	3.76
1500.0	20.51	23.94	20.97	18.73	1.07	0.53	33.93	19.30	3.66
1600.0	20.35	23.93	21.43	18.68	1.08	0.54	33.71	19.38	3.70
1700.0	20.27	23.83	22.22	17.95	1.08	0.54	33.25	19.29	3.61
1800.0	20.16	23.75	23.08	17.52	1.08	0.54	33.16	19.23	3.75
1900.0	20.02	23.74	23.87	17.34	1.08	0.55	32.73	18.99	3.67
2000.0	19.88	23.70	25.04	17.16	1.09	0.56	32.56	18.79	3.68
2100.0	19.75	23.71	25.78	16.79	1.09	0.57	32.26	18.67	3.64
2200.0	19.63	23.65	27.50	16.66	1.10	0.58	32.12	18.55	3.62
2300.0	19.50	23.63	29.30	16.60	1.10	0.59	31.93	18.37	3.71
2400.0	19.35	23.63	30.73	16.51	1.11	0.60	31.37	18.25	3.70
2500.0	19.20	23.62	32.35	16.64	1.12	0.61	30.97	17.86	3.80
2600.0	19.07	23.57	32.21	16.55	1.12	0.62	30.96	17.69	3.73
2700.0	18.94	23.64	31.53	16.69	1.13	0.64	30.74	17.64	3.72
2800.0	18.80	23.64	29.51	16.48	1.14	0.65	30.49	17.50	3.85
2900.0	18.65	23.69	29.20	16.86	1.15	0.67	30.09	17.33	3.77
3000.0	18.54	23.70	27.09	16.80	1.16	0.68	29.90	17.17	3.71
3100.0	18.38	23.75	26.36	16.83	1.17	0.70	29.85	17.04	3.77
3200.0	18.23	23.82	25.73	17.03	1.19	0.71	29.67	16.81	3.77
3300.0	18.13	23.84	24.14	17.07	1.19	0.72	29.44	16.97	3.78
3400.0	18.05	23.86	22.84	17.19	1.20	0.73	29.27	16.67	3.70
3500.0	17.94	23.87	21.90	17.19	1.21	0.74	28.93	16.40	3.88
3600.0	17.79	23.94	21.70	17.14	1.23	0.75	29.12	16.31	3.80
3800.0	17.61	24.12	20.28	17.36	1.25	0.78	28.87	16.01	3.83
4000.0	17.30	24.21	19.98	17.24	1.29	0.80	28.94	15.76	3.95
4200.0	17.17	24.34	18.43	17.08	1.31	0.82	28.32	15.19	3.95
4400.0	16.96	24.71	18.11	17.44	1.37	0.84	28.05	14.60	3.98
4600.0	16.84	25.21	17.68	17.76	1.44	0.87	27.88	14.32	4.05
4800.0	16.68	25.27	16.49	17.10	1.46	0.88	27.60	13.90	4.13
5000.0	16.44	25.34	15.92	16.72	1.49	0.89	26.88	13.35	4.22
5200.0	16.18	25.25	15.20	15.68	1.49	0.90	26.85	13.30	4.29
5400.0	16.27	26.08	15.69	16.94	1.61	0.92	25.98	12.75	4.39
5600.0	16.25	26.48	13.54	15.66	1.63	0.94	26.22	12.62	4.32
5800.0	16.14	26.48	13.42	15.49	1.64	0.95	25.51	12.23	4.47
6000.0	16.26	27.02	13.37	15.65	1.71	0.95	24.98	11.79	4.51

## Typical Performance Data

**Definitions:**

Input Return Loss = -S11 (dB)

Gain(Power Gain) = S21 (dB)

Reverse Isolation = -S12 (dB)

Output Return Loss = -S22 (dB)

TEST CONDITIONS: Vd = 4.5V, Id =48.94 mA @ Temperature = +25degC

FREQ	Gain	Isolation	Input Return Loss	Output Return Loss	Stability		IP-3 Output	1dB Comp. Output	Noise Figure
					K	Measure			
(MHz)	(dB)	(dB)	(dB)	(dB)	K	Measure	(dBm)	(dBm)	(dB)
10.0	23.94	26.87	10.33	5.72	0.87	0.23	---	15.63	2.79
30.0	22.17	24.91	15.43	10.66	0.94	0.46	29.83	15.90	3.38
50.0	21.56	24.38	18.65	13.66	0.99	0.48	28.82	15.34	3.47
100.0	21.17	24.20	22.31	17.22	1.03	0.50	29.31	15.46	3.49
200.0	21.03	24.12	24.03	18.98	1.05	0.51	29.40	15.06	3.38
300.0	20.99	24.03	24.13	19.44	1.05	0.50	29.64	15.08	3.57
400.0	20.95	24.10	23.97	19.73	1.05	0.51	29.66	15.38	3.67
500.0	20.92	24.02	23.54	19.93	1.05	0.51	29.52	15.34	3.62
600.0	20.88	24.00	23.26	20.11	1.05	0.51	29.90	15.48	3.64
700.0	20.83	24.00	23.00	20.15	1.06	0.51	30.37	15.71	3.61
800.0	20.78	23.97	22.80	20.30	1.06	0.51	30.39	15.74	3.55
1000.0	20.66	23.84	22.71	20.06	1.06	0.51	29.60	15.75	3.62
1100.0	20.59	23.78	22.82	19.84	1.06	0.51	29.82	15.89	3.56
1200.0	20.51	23.75	23.03	19.45	1.06	0.51	30.74	16.28	3.55
1300.0	20.43	23.72	23.35	19.12	1.07	0.51	30.47	16.22	3.54
1400.0	20.33	23.62	23.80	18.64	1.07	0.51	29.85	16.30	3.59
1500.0	20.24	23.59	24.47	18.22	1.07	0.52	30.07	16.39	3.51
1600.0	20.08	23.60	25.07	18.26	1.08	0.53	30.41	16.76	3.53
1700.0	20.01	23.54	26.25	17.60	1.08	0.53	30.39	16.88	3.46
1800.0	19.90	23.46	27.48	17.19	1.08	0.53	30.23	16.93	3.58
1900.0	19.76	23.45	28.66	17.01	1.08	0.55	29.86	16.68	3.49
2000.0	19.63	23.41	30.40	16.84	1.08	0.56	29.67	16.57	3.53
2100.0	19.50	23.38	31.05	16.50	1.09	0.56	29.78	16.58	3.45
2200.0	19.38	23.37	33.08	16.35	1.09	0.58	29.82	16.59	3.46
2300.0	19.24	23.34	33.29	16.23	1.09	0.59	29.70	16.55	3.52
2400.0	19.10	23.35	32.60	16.15	1.10	0.60	29.41	16.54	3.54
2500.0	18.95	23.37	31.19	16.21	1.11	0.62	28.93	16.21	3.62
2600.0	18.82	23.40	29.15	16.10	1.12	0.63	29.13	16.17	3.56
2700.0	18.69	23.38	27.52	16.17	1.12	0.64	29.12	16.16	3.55
2800.0	18.55	23.40	26.17	15.98	1.13	0.66	28.80	16.08	3.65
2900.0	18.40	23.49	25.42	16.26	1.15	0.68	28.53	15.96	3.59
3000.0	18.28	23.42	24.01	16.12	1.15	0.68	28.43	15.83	3.48
3100.0	18.12	23.46	23.52	16.13	1.16	0.70	28.29	15.72	3.57
3200.0	17.97	23.59	23.02	16.32	1.18	0.72	28.32	15.56	3.58
3300.0	17.88	23.57	21.85	16.25	1.18	0.72	28.09	15.72	3.57
3400.0	17.79	23.65	20.87	16.28	1.19	0.74	27.86	15.44	3.54
3500.0	17.67	23.67	20.18	16.19	1.20	0.75	27.55	15.21	3.65
3600.0	17.53	23.74	20.06	16.15	1.22	0.76	27.68	15.15	3.59
3800.0	17.34	23.89	18.94	16.22	1.24	0.78	27.55	14.89	3.65
4000.0	17.03	24.01	18.73	16.11	1.28	0.80	27.41	14.73	3.69
4200.0	16.90	24.09	17.43	15.84	1.29	0.82	27.05	14.18	3.73
4400.0	16.68	24.49	17.19	16.10	1.36	0.85	26.69	13.67	3.80
4600.0	16.55	24.99	16.86	16.28	1.43	0.87	26.55	13.40	3.78
4800.0	16.39	25.06	15.86	15.68	1.44	0.88	26.26	12.99	3.90
5000.0	16.14	25.16	15.36	15.34	1.48	0.89	25.68	12.49	3.92
5200.0	15.88	25.05	14.70	14.47	1.48	0.90	25.67	12.44	4.01
5400.0	15.96	25.86	15.18	15.43	1.60	0.92	24.76	11.91	4.08
5600.0	15.93	26.23	13.21	14.31	1.61	0.94	25.03	11.76	4.06
5800.0	15.80	26.27	13.13	14.17	1.63	0.94	24.35	11.38	4.19
6000.0	15.91	26.76	13.12	14.26	1.70	0.95	23.84	10.95	4.22

## Typical Performance Data

**Definitions:**

Input Return Loss = -S11 (dB)

Gain(Power Gain) = S21 (dB)

Reverse Isolation = -S12 (dB)

Output Return Loss = -S22 (dB)

TEST CONDITIONS: Vd = 5.5V, Id = 88.54 mA @ Temperature = +25degC

FREQ	Gain	Isolation	Input Return Loss	Output Return Loss	Stability		IP-3 Output	1dB Comp. Output	Noise Figure
					K	Measure			
(MHz)	(dB)	(dB)	(dB)	(dB)	K	Measure	(dBm)	(dBm)	(dB)
10.0	24.65	28.04	11.96	6.61	0.87	0.39	---	20.17	3.11
30.0	22.75	25.40	15.32	11.59	0.94	0.48	38.98	21.30	3.77
50.0	22.11	24.74	17.08	15.08	0.99	0.48	38.13	21.24	3.81
100.0	21.69	24.67	18.47	19.73	1.03	0.51	38.69	21.21	3.85
200.0	21.55	24.64	18.87	22.88	1.05	0.53	38.99	21.09	3.76
300.0	21.50	24.64	18.92	23.76	1.05	0.53	39.86	21.12	4.01
400.0	21.46	24.61	18.84	24.14	1.05	0.53	38.54	21.17	4.05
500.0	21.41	24.55	18.70	24.33	1.05	0.53	37.29	21.20	3.99
600.0	21.36	24.51	18.60	24.36	1.06	0.52	37.62	21.20	3.99
700.0	21.31	24.49	18.49	23.99	1.06	0.53	37.76	21.27	3.97
800.0	21.25	24.45	18.48	23.73	1.06	0.53	37.29	21.25	3.95
1000.0	21.10	24.32	18.53	22.54	1.06	0.52	35.82	21.29	3.98
1100.0	21.02	24.27	18.63	21.87	1.06	0.52	35.36	21.29	3.91
1200.0	20.94	24.23	18.80	21.06	1.07	0.52	36.30	21.27	3.95
1300.0	20.84	24.16	19.05	20.42	1.07	0.52	34.86	21.19	3.91
1400.0	20.74	24.10	19.36	19.75	1.07	0.52	34.60	21.11	3.96
1500.0	20.64	24.04	19.79	19.15	1.07	0.53	34.12	21.00	3.88
1600.0	20.48	24.03	20.22	19.06	1.08	0.54	33.78	20.91	3.92
1700.0	20.40	23.94	20.97	18.32	1.08	0.54	33.86	20.74	3.80
1800.0	20.29	23.91	21.72	17.90	1.08	0.54	33.11	20.51	3.95
1900.0	20.15	23.82	22.50	17.69	1.08	0.55	32.84	20.23	3.85
2000.0	20.01	23.82	23.50	17.55	1.09	0.56	32.48	19.95	3.87
2100.0	19.88	23.82	24.13	17.19	1.09	0.57	32.04	19.77	3.86
2200.0	19.76	23.75	25.76	17.10	1.10	0.57	32.11	19.57	3.85
2300.0	19.63	23.68	27.38	17.07	1.10	0.58	31.70	19.33	3.92
2400.0	19.48	23.76	28.86	17.02	1.11	0.60	31.62	19.15	3.89
2500.0	19.34	23.75	30.82	17.19	1.12	0.62	30.83	18.72	3.98
2600.0	19.20	23.69	31.60	17.16	1.12	0.62	30.91	18.52	3.95
2700.0	19.08	23.71	32.27	17.35	1.13	0.64	30.65	18.44	3.94
2800.0	18.93	23.72	30.28	17.17	1.14	0.65	30.44	18.28	4.04
2900.0	18.78	23.77	30.39	17.67	1.15	0.67	30.22	18.09	3.99
3000.0	18.67	23.76	28.16	17.63	1.16	0.68	29.99	17.93	3.94
3100.0	18.51	23.82	27.32	17.71	1.17	0.69	29.89	17.74	3.98
3200.0	18.36	23.89	26.64	18.00	1.19	0.71	29.89	17.50	4.01
3300.0	18.27	23.93	24.81	18.09	1.20	0.72	29.67	17.66	4.00
3400.0	18.19	23.96	23.39	18.35	1.20	0.73	29.33	17.33	3.94
3500.0	18.08	23.99	22.35	18.40	1.21	0.74	29.08	17.02	4.12
3600.0	17.93	24.04	22.11	18.42	1.23	0.75	29.22	16.96	4.06
3800.0	17.75	24.21	20.59	18.83	1.26	0.78	28.88	16.59	4.12
4000.0	17.44	24.34	20.18	18.76	1.30	0.80	28.77	16.29	4.19
4200.0	17.31	24.48	18.58	18.67	1.32	0.82	28.23	15.71	4.22
4400.0	17.10	24.84	18.20	19.16	1.38	0.84	27.86	15.12	4.32
4600.0	16.99	25.24	17.70	19.70	1.44	0.87	27.44	14.82	4.31
4800.0	16.83	25.42	16.50	18.96	1.47	0.88	27.12	14.37	4.46
5000.0	16.59	25.50	15.90	18.52	1.50	0.90	26.41	13.82	4.55
5200.0	16.33	25.41	15.13	17.28	1.51	0.90	26.40	13.80	4.62
5400.0	16.43	26.21	15.61	18.94	1.62	0.92	25.58	13.24	4.74
5600.0	16.42	26.66	13.44	17.31	1.65	0.95	25.59	13.09	4.67
5800.0	16.30	26.64	13.29	17.20	1.66	0.95	25.00	12.74	4.82
6000.0	16.43	27.27	13.26	17.36	1.74	0.96	24.45	12.26	4.91



## Typical Performance Data

**Definitions:**

Input Return Loss = -S11 (dB)

Gain(Power Gain) = S21 (dB)

Reverse Isolation = -S12 (dB)

Output Return Loss = -S22 (dB)

TEST CONDITIONS: Vd = 5V, Id = 63.65 mA @ Temperature = -45degC

FREQ	Gain	Isolation	Input Return Loss	Output Return Loss	Stability		IP-3 Output	1dB Comp. Output	Noise Figure
					K	Measure			
(MHz)	(dB)	(dB)	(dB)	(dB)	K	Measure	(dBm)	(dBm)	(dB)
10.0	24.55	27.51	10.81	6.11	0.87	0.28	---	18.00	2.29
30.0	22.70	25.38	15.39	11.43	0.94	0.47	35.30	18.85	2.90
50.0	22.08	24.86	17.33	14.67	0.99	0.49	33.68	18.28	2.94
100.0	21.69	24.66	19.70	18.60	1.03	0.51	33.96	18.40	3.00
200.0	21.56	24.55	20.64	20.76	1.04	0.51	34.28	17.97	2.88
300.0	21.52	24.54	19.53	22.57	1.04	0.51	34.08	18.07	3.11
400.0	21.48	24.57	19.10	23.29	1.05	0.52	34.53	18.36	3.13
500.0	21.44	24.52	18.97	23.00	1.05	0.52	34.27	18.33	3.09
600.0	21.40	24.49	18.86	22.67	1.05	0.52	34.34	18.45	3.13
700.0	21.36	24.45	18.87	22.01	1.05	0.51	34.65	18.62	3.10
800.0	21.30	24.41	18.98	21.61	1.05	0.51	35.13	18.62	3.06
1000.0	21.18	24.29	19.02	20.73	1.06	0.51	33.91	18.60	3.07
1100.0	21.10	24.22	18.71	19.93	1.06	0.50	34.30	18.71	3.04
1200.0	21.02	24.24	18.60	19.22	1.06	0.51	35.01	19.01	3.02
1300.0	20.93	24.12	18.53	18.57	1.06	0.50	34.34	18.97	3.04
1400.0	20.83	24.07	18.50	17.76	1.06	0.50	34.21	19.02	3.07
1500.0	20.74	24.04	18.86	17.24	1.07	0.51	34.04	19.04	3.00
1600.0	20.62	23.99	19.43	16.99	1.07	0.51	34.59	19.25	3.02
1700.0	20.52	23.96	19.83	16.52	1.07	0.51	33.95	19.22	2.93
1800.0	20.42	23.86	20.10	16.06	1.07	0.51	33.74	19.26	3.04
1900.0	20.27	23.87	20.65	15.94	1.08	0.53	33.46	19.06	3.00
2000.0	20.14	23.81	21.14	15.69	1.08	0.53	33.22	18.90	3.01
2100.0	20.02	23.77	21.64	15.35	1.08	0.54	32.95	18.90	2.97
2200.0	19.88	23.81	21.90	15.11	1.09	0.55	32.95	18.86	2.96
2300.0	19.77	23.70	22.63	14.90	1.09	0.55	32.75	18.73	3.02
2400.0	19.64	23.71	23.53	14.84	1.09	0.57	32.41	18.64	3.03
2500.0	19.50	23.74	24.21	14.83	1.10	0.58	31.76	18.35	3.07
2600.0	19.39	23.64	25.32	14.70	1.10	0.58	32.04	18.19	3.03
2700.0	19.27	23.66	26.66	14.88	1.11	0.60	31.78	18.19	3.04
2800.0	19.10	23.73	28.20	15.11	1.12	0.62	31.41	18.01	3.10
2900.0	18.98	23.74	28.56	15.12	1.13	0.63	30.97	17.86	3.05
3000.0	18.90	23.70	28.71	15.31	1.13	0.64	30.73	17.75	2.97
3100.0	18.79	23.72	28.63	15.39	1.14	0.65	30.77	17.61	2.99
3200.0	18.65	23.77	28.68	15.46	1.15	0.67	30.71	17.46	3.02
3300.0	18.53	23.76	27.82	15.28	1.16	0.67	30.32	17.56	2.98
3400.0	18.38	23.90	27.46	15.42	1.18	0.69	30.03	17.26	2.95
3500.0	18.30	23.86	25.54	15.20	1.18	0.70	29.72	17.03	3.10
3600.0	18.23	23.88	24.75	15.48	1.18	0.71	29.80	17.04	3.00
3800.0	18.04	23.98	23.62	15.40	1.20	0.73	29.64	16.88	3.05
4000.0	17.77	24.09	23.05	15.39	1.24	0.75	29.55	16.71	3.10
4200.0	17.65	24.19	21.63	14.99	1.25	0.76	28.96	16.23	3.11
4400.0	17.48	24.43	20.74	14.92	1.28	0.78	28.91	15.77	3.15
4600.0	17.10	24.74	23.47	15.35	1.37	0.81	29.00	15.52	3.19
4800.0	17.12	24.66	19.71	14.30	1.33	0.81	28.84	15.13	3.26
5000.0	17.16	25.09	18.60	14.42	1.37	0.83	28.44	14.59	3.28
5200.0	16.75	24.87	18.69	13.80	1.39	0.83	28.31	14.44	3.34
5400.0	17.08	26.01	18.62	14.85	1.49	0.87	27.66	13.88	3.39
5600.0	16.93	25.86	19.72	14.83	1.50	0.86	27.76	13.78	3.34
5800.0	16.92	25.96	17.26	14.16	1.49	0.87	27.32	13.44	3.45
6000.0	17.12	26.31	16.66	14.41	1.50	0.88	26.88	12.97	3.51

## Typical Performance Data

### Definitions:

Input Return Loss = -S11 (dB)  
 Gain(Power Gain) = S21 (dB)  
 Reverse Isolation = -S12 (dB)  
 Output Return Loss = -S22 (dB)

TEST CONDITIONS: Vd = 4.5V, Id = 46.01 mA @ Temperature = -45degC

FREQ	Gain	Isolation	Input Return Loss	Output Return Loss	Stability		IP-3 Output	1dB Comp. Output	Noise Figure
					K	Measure			
(MHz)	(dB)	(dB)	(dB)	(dB)	K	Measure	(dBm)	(dBm)	(dB)
10.0	24.18	27.45	10.94	6.04	0.87	0.31	---	15.12	2.15
30.0	22.35	24.97	15.46	10.87	0.94	0.45	29.64	15.06	2.79
50.0	21.74	24.45	18.37	13.84	0.99	0.47	28.32	14.47	2.80
100.0	21.36	24.34	22.13	17.09	1.03	0.50	28.65	14.58	2.87
200.0	21.24	24.31	24.27	18.59	1.04	0.51	28.59	14.14	2.72
300.0	21.20	24.23	22.68	20.01	1.04	0.50	28.90	14.26	2.92
400.0	21.17	24.23	22.01	20.68	1.05	0.51	29.00	14.57	3.00
500.0	21.14	24.17	21.80	20.64	1.05	0.50	28.90	14.54	2.99
600.0	21.10	24.15	21.61	20.57	1.05	0.50	29.31	14.69	2.97
700.0	21.06	24.15	21.58	20.19	1.05	0.50	29.68	14.93	2.94
800.0	21.01	24.10	21.65	19.97	1.05	0.50	29.83	14.92	2.94
1000.0	20.90	24.00	21.59	19.57	1.06	0.50	28.96	14.95	2.95
1100.0	20.84	23.94	21.17	19.11	1.06	0.50	29.35	15.11	2.93
1200.0	20.77	23.89	21.01	18.63	1.06	0.50	30.28	15.55	2.90
1300.0	20.68	23.84	20.86	18.17	1.06	0.50	29.89	15.53	2.90
1400.0	20.58	23.79	20.79	17.49	1.06	0.50	29.50	15.62	2.95
1500.0	20.50	23.76	21.18	17.02	1.06	0.50	29.82	15.73	2.86
1600.0	20.38	23.69	21.84	16.79	1.06	0.50	30.07	16.18	2.89
1700.0	20.29	23.66	22.25	16.33	1.06	0.51	30.18	16.27	2.78
1800.0	20.19	23.64	22.49	15.90	1.07	0.51	30.10	16.55	2.92
1900.0	20.05	23.60	23.12	15.80	1.07	0.52	29.86	16.31	2.84
2000.0	19.92	23.49	23.54	15.50	1.07	0.52	29.75	16.23	2.85
2100.0	19.80	23.52	24.01	15.15	1.08	0.54	29.85	16.44	2.81
2200.0	19.66	23.49	24.08	14.95	1.08	0.55	30.12	16.65	2.81
2300.0	19.55	23.48	24.65	14.68	1.08	0.55	30.10	16.54	2.87
2400.0	19.42	23.47	25.27	14.58	1.09	0.57	29.71	16.67	2.86
2500.0	19.28	23.46	25.68	14.53	1.09	0.58	29.21	16.36	2.95
2600.0	19.17	23.43	26.34	14.41	1.09	0.59	29.59	16.41	2.89
2700.0	19.05	23.46	27.03	14.49	1.10	0.60	29.52	16.44	2.89
2800.0	18.88	23.50	28.24	14.68	1.11	0.62	29.21	16.41	2.95
2900.0	18.76	23.52	27.78	14.65	1.12	0.63	29.11	16.32	2.92
3000.0	18.68	23.46	26.71	14.75	1.12	0.64	28.93	16.23	2.82
3100.0	18.56	23.46	26.29	14.81	1.13	0.65	28.87	16.13	2.84
3200.0	18.43	23.55	26.18	14.84	1.14	0.67	28.91	16.01	2.86
3300.0	18.31	23.60	25.41	14.65	1.15	0.68	28.63	16.20	2.84
3400.0	18.16	23.67	25.18	14.80	1.17	0.69	28.34	15.90	2.79
3500.0	18.08	23.62	23.61	14.53	1.17	0.70	28.21	15.72	2.94
3600.0	18.00	23.68	22.83	14.78	1.18	0.71	28.14	15.77	2.85
3800.0	17.81	23.80	21.96	14.64	1.20	0.73	28.14	15.65	2.90
4000.0	17.54	23.87	21.60	14.65	1.22	0.75	27.93	15.55	2.97
4200.0	17.42	23.93	20.39	14.20	1.23	0.76	27.60	15.17	2.93
4400.0	17.24	24.21	19.70	14.11	1.27	0.78	27.46	14.72	2.93
4600.0	16.87	24.51	22.14	14.62	1.36	0.81	27.52	14.52	3.03
4800.0	16.87	24.50	18.91	13.51	1.33	0.81	27.34	14.17	3.06
5000.0	16.89	24.87	17.90	13.52	1.36	0.83	26.98	13.65	3.09
5200.0	16.50	24.65	18.22	13.07	1.38	0.82	26.90	13.54	3.12
5400.0	16.80	25.74	17.96	13.80	1.47	0.86	26.20	13.03	3.19
5600.0	16.63	25.62	19.00	13.74	1.49	0.86	26.46	12.92	3.15
5800.0	16.64	25.67	16.90	13.23	1.47	0.87	25.90	12.54	3.25
6000.0	16.82	26.06	16.32	13.35	1.49	0.88	25.55	12.13	3.28

*Typical Performance Data*

**Definitions:**

Input Return Loss = -S11 (dB)

Gain(Power Gain) = S21 (dB)

Reverse Isolation = -S12 (dB)

Output Return Loss = -S22 (dB)

TEST CONDITIONS: Vd = 5.5V, Id = 82.05 mA @ Temperature = -45degC

FREQ	Gain	Isolation	Input Return Loss	Output Return Loss	Stability		IP-3 Output	1dB Comp. Output	Noise Figure
					K	Measure			
(MHz)	(dB)	(dB)	(dB)	(dB)			(dBm)	(dBm)	(dB)
10.0	24.76	28.46	11.24	6.32	0.87	0.39	---	19.89	2.43
30.0	22.87	25.44	15.20	11.65	0.94	0.47	40.78	20.96	3.08
50.0	22.24	25.23	16.86	15.05	1.00	0.52	37.97	20.81	3.09
100.0	21.85	24.82	18.63	19.36	1.03	0.51	38.08	20.80	3.12
200.0	21.72	24.70	19.29	21.96	1.04	0.51	37.81	20.56	3.03
300.0	21.67	24.69	18.32	24.00	1.04	0.52	37.84	20.63	3.21
400.0	21.63	24.68	17.94	24.72	1.05	0.52	38.92	20.77	3.28
500.0	21.59	24.67	17.84	24.27	1.05	0.52	38.65	20.79	3.21
600.0	21.54	24.60	17.79	23.79	1.05	0.51	37.77	20.82	3.25
700.0	21.50	24.57	17.81	22.93	1.05	0.51	38.75	20.92	3.21
800.0	21.44	24.56	17.92	22.39	1.06	0.52	38.90	20.92	3.18
1000.0	21.31	24.43	17.99	21.29	1.06	0.51	37.10	20.93	3.21
1100.0	21.24	24.43	17.73	20.33	1.06	0.51	36.93	20.99	3.18
1200.0	21.16	24.35	17.66	19.49	1.06	0.51	37.46	21.08	3.19
1300.0	21.06	24.29	17.58	18.73	1.06	0.51	37.33	21.06	3.17
1400.0	20.96	24.25	17.58	17.91	1.06	0.51	36.56	21.04	3.22
1500.0	20.87	24.22	17.90	17.41	1.07	0.51	36.40	20.97	3.14
1600.0	20.75	24.09	18.47	17.13	1.07	0.51	36.59	21.00	3.18
1700.0	20.66	24.07	18.82	16.66	1.07	0.51	35.94	20.90	3.08
1800.0	20.55	24.03	19.11	16.19	1.07	0.52	35.39	20.79	3.21
1900.0	20.40	23.98	19.64	16.08	1.08	0.53	34.85	20.59	3.14
2000.0	20.28	23.93	20.12	15.86	1.08	0.53	34.97	20.38	3.12
2100.0	20.16	23.94	20.61	15.53	1.08	0.54	34.53	20.24	3.12
2200.0	20.02	23.87	20.83	15.34	1.09	0.55	34.52	20.16	3.10
2300.0	19.91	23.85	21.58	15.12	1.09	0.55	33.97	19.92	3.16
2400.0	19.78	23.84	22.43	15.09	1.09	0.57	33.57	19.77	3.14
2500.0	19.64	23.84	23.08	15.08	1.10	0.58	32.87	19.41	3.23
2600.0	19.53	23.80	24.26	15.11	1.10	0.59	32.84	19.17	3.21
2700.0	19.41	23.80	25.57	15.25	1.11	0.60	32.56	19.17	3.17
2800.0	19.24	23.85	27.03	15.50	1.12	0.62	32.26	18.93	3.25
2900.0	19.12	23.86	27.58	15.52	1.13	0.63	31.86	18.77	3.17
3000.0	19.04	23.84	28.29	15.81	1.14	0.64	31.70	18.63	3.13
3100.0	18.93	23.83	28.61	15.94	1.14	0.65	31.66	18.49	3.13
3200.0	18.80	23.89	28.85	16.00	1.15	0.67	31.51	18.31	3.15
3300.0	18.68	23.91	28.01	15.85	1.16	0.68	31.04	18.45	3.14
3400.0	18.53	24.03	27.68	16.00	1.18	0.69	30.77	18.15	3.11
3500.0	18.46	23.98	25.97	15.75	1.18	0.70	30.48	17.92	3.25
3600.0	18.38	24.08	25.26	16.20	1.20	0.71	30.46	17.90	3.18
3800.0	18.19	24.11	24.15	16.13	1.21	0.73	30.23	17.75	3.23
4000.0	17.93	24.23	23.42	16.13	1.24	0.75	30.23	17.54	3.30
4200.0	17.82	24.31	21.91	15.75	1.25	0.76	29.77	17.02	3.29
4400.0	17.65	24.54	20.99	15.69	1.29	0.78	29.61	16.51	3.32
4600.0	17.26	24.86	23.64	16.09	1.37	0.81	29.76	16.22	3.43
4800.0	17.31	24.86	19.84	15.11	1.34	0.81	29.51	15.87	3.47
5000.0	17.35	25.26	18.79	15.34	1.38	0.83	29.09	15.30	3.49
5200.0	16.94	24.98	18.68	14.54	1.39	0.83	29.05	15.13	3.53
5400.0	17.30	26.19	18.98	15.96	1.50	0.87	28.34	14.59	3.61
5600.0	17.19	26.07	20.21	16.02	1.51	0.86	28.44	14.56	3.57
5800.0	17.09	26.10	17.29	15.15	1.50	0.88	27.96	14.08	3.70
6000.0	17.36	26.47	17.25	15.56	1.51	0.88	27.62	13.69	3.74

## Typical Performance Data

**Definitions:**

Input Return Loss = -S11 (dB)

Gain(Power Gain) = S21 (dB)

Reverse Isolation = -S12 (dB)

Output Return Loss = -S22 (dB)

TEST CONDITIONS: Vd = 5V, Id = 70.8 mA @ Temperature = +85degC

FREQ	Gain	Isolation	Input Return Loss	Output Return Loss	Stability		IP-3 Output	1dB Comp. Output	Noise Figure
					K	Measure			
(MHz)	(dB)	(dB)	(dB)	(dB)			(dBm)	(dBm)	(dB)
10.0	24.26	27.12	10.76	5.98	0.86	0.25	---	18.45	3.40
30.0	22.44	25.09	15.51	11.18	0.94	0.46	36.32	19.56	4.06
50.0	21.82	24.57	17.85	14.52	0.99	0.48	34.79	19.31	4.11
100.0	21.41	24.44	19.60	19.20	1.03	0.52	35.23	19.34	4.16
200.0	21.25	24.36	19.61	22.52	1.05	0.53	34.93	19.13	4.05
300.0	21.20	24.36	20.27	22.60	1.05	0.53	35.33	19.14	4.35
400.0	21.15	24.34	20.76	22.30	1.05	0.53	35.39	19.24	4.36
500.0	21.11	24.28	20.58	22.47	1.06	0.52	34.76	19.22	4.30
600.0	21.06	24.28	20.54	22.79	1.06	0.53	35.23	19.29	4.33
700.0	21.00	24.24	20.60	22.76	1.06	0.53	35.46	19.39	4.28
800.0	20.94	24.17	20.74	22.80	1.06	0.52	35.53	19.39	4.30
1000.0	20.80	24.05	20.95	22.72	1.07	0.52	34.09	19.38	4.30
1100.0	20.72	24.02	21.10	22.50	1.07	0.53	34.44	19.44	4.27
1200.0	20.63	23.94	21.41	21.99	1.07	0.53	34.92	19.54	4.25
1300.0	20.53	23.90	21.71	21.69	1.07	0.53	34.38	19.47	4.23
1400.0	20.42	23.84	22.20	21.14	1.07	0.53	33.52	19.42	4.31
1500.0	20.32	23.75	22.83	20.56	1.08	0.53	33.51	19.33	4.20
1600.0	20.19	23.74	23.62	20.15	1.08	0.54	33.57	19.35	4.24
1700.0	20.08	23.67	24.60	19.58	1.08	0.55	32.60	19.21	4.10
1800.0	19.95	23.67	25.67	19.09	1.09	0.56	32.63	19.06	4.29
1900.0	19.80	23.62	27.23	19.02	1.09	0.57	31.84	18.76	4.19
2000.0	19.65	23.58	29.10	18.84	1.10	0.58	31.85	18.53	4.23
2100.0	19.52	23.55	31.78	18.46	1.10	0.59	31.44	18.36	4.22
2200.0	19.37	23.53	34.73	18.23	1.11	0.60	31.31	18.15	4.19
2300.0	19.24	23.49	39.82	18.20	1.11	0.61	30.98	17.92	4.22
2400.0	19.09	23.52	36.88	18.16	1.12	0.62	30.74	17.77	4.30
2500.0	18.93	23.56	33.57	18.23	1.13	0.64	30.10	17.36	4.35
2600.0	18.79	23.55	29.82	18.17	1.14	0.65	30.08	17.17	4.31
2700.0	18.64	23.56	27.57	18.34	1.15	0.67	30.01	17.08	4.30
2800.0	18.46	23.65	26.28	18.81	1.17	0.69	29.56	16.93	4.41
2900.0	18.33	23.60	24.40	18.55	1.17	0.70	29.29	16.73	4.37
3000.0	18.20	23.63	22.94	19.00	1.18	0.71	29.04	16.54	4.29
3100.0	18.06	23.71	21.98	19.34	1.19	0.73	28.89	16.32	4.36
3200.0	17.92	23.80	21.26	19.69	1.21	0.75	28.84	16.14	4.34
3300.0	17.78	23.82	20.36	19.51	1.22	0.76	28.52	16.27	4.36
3400.0	17.61	23.98	20.14	20.02	1.25	0.78	28.27	15.91	4.34
3500.0	17.49	23.94	19.26	19.59	1.25	0.78	27.86	15.62	4.49
3600.0	17.36	24.09	18.78	20.10	1.28	0.80	27.98	15.53	4.42
3800.0	17.14	24.21	17.64	19.91	1.31	0.82	27.54	15.03	4.53
4000.0	16.82	24.43	17.30	20.02	1.36	0.85	27.25	14.75	4.62
4200.0	16.66	24.62	16.13	19.56	1.39	0.87	26.55	14.14	4.66
4400.0	16.45	24.95	15.45	19.67	1.45	0.89	26.00	13.55	4.67
4600.0	16.03	24.98	15.90	19.88	1.51	0.90	25.64	13.22	4.79
4800.0	16.03	25.45	13.98	18.82	1.55	0.93	25.22	12.81	4.92
5000.0	15.80	25.72	13.52	18.95	1.61	0.94	24.46	12.28	5.01
5200.0	15.51	25.66	12.69	17.96	1.62	0.96	24.54	12.28	5.07
5400.0	15.48	26.35	12.81	19.13	1.75	0.97	23.76	11.74	5.24
5600.0	15.31	26.32	12.32	18.64	1.76	0.98	23.76	11.56	5.21
5800.0	15.14	26.77	11.13	16.57	1.81	1.01	23.33	11.30	5.32
6000.0	15.24	26.94	11.52	17.24	1.85	1.00	22.72	10.78	5.44

## Typical Performance Data

**Definitions:**

Input Return Loss = -S11 (dB)

Gain(Power Gain) = S21 (dB)

Reverse Isolation = -S12 (dB)

Output Return Loss = -S22 (dB)

TEST CONDITIONS: Vd = 4.5V, Id = 51.63 mA @ Temperature = +85degC

FREQ	Gain	Isolation	Input Return Loss	Output Return Loss	Stability		IP-3 Output	1dB Comp. Output	Noise Figure
					K	Measure			
(MHz)	(dB)	(dB)	(dB)	(dB)	K	Measure	(dBm)	(dBm)	(dB)
10.0	23.86	27.34	10.62	5.97	0.87	0.33	---	16.02	3.15
30.0	22.07	24.72	15.43	10.59	0.94	0.44	31.38	16.57	3.84
50.0	21.47	24.16	18.69	13.66	0.99	0.46	29.64	16.01	3.93
100.0	21.07	24.11	22.16	17.54	1.03	0.51	30.14	16.18	3.96
200.0	20.92	24.04	22.74	19.92	1.05	0.52	30.31	15.84	3.89
300.0	20.87	24.03	23.77	19.96	1.05	0.52	30.10	15.85	4.10
400.0	20.83	23.98	24.47	19.66	1.05	0.51	30.44	16.06	4.16
500.0	20.79	23.98	24.08	19.80	1.06	0.52	30.11	16.00	4.11
600.0	20.74	23.93	23.89	20.09	1.06	0.51	30.53	16.16	4.13
700.0	20.70	23.92	23.85	20.16	1.06	0.52	30.77	16.35	4.09
800.0	20.64	23.87	23.86	20.27	1.06	0.52	31.02	16.36	4.06
1000.0	20.52	23.75	23.95	20.48	1.06	0.51	30.10	16.37	4.11
1100.0	20.44	23.75	24.09	20.47	1.07	0.52	30.45	16.49	4.06
1200.0	20.36	23.69	24.39	20.29	1.07	0.52	31.35	16.81	4.04
1300.0	20.27	23.63	24.80	20.21	1.07	0.52	30.92	16.77	4.06
1400.0	20.17	23.54	25.45	19.89	1.07	0.52	30.34	16.84	4.10
1500.0	20.07	23.51	26.41	19.51	1.07	0.53	30.61	16.87	4.02
1600.0	19.95	23.48	27.51	19.28	1.08	0.54	30.71	17.11	4.05
1700.0	19.84	23.42	28.94	18.82	1.08	0.54	30.71	17.13	3.94
1800.0	19.72	23.39	30.94	18.46	1.08	0.55	30.62	17.17	4.10
1900.0	19.57	23.37	33.84	18.38	1.09	0.57	30.05	16.91	4.03
2000.0	19.42	23.35	37.86	18.27	1.09	0.58	29.98	16.75	4.03
2100.0	19.30	23.31	44.41	17.89	1.10	0.59	29.89	16.68	3.99
2200.0	19.15	23.31	39.56	17.65	1.10	0.60	29.80	16.58	3.98
2300.0	19.02	23.27	33.83	17.56	1.11	0.61	29.77	16.48	4.04
2400.0	18.87	23.29	30.36	17.47	1.11	0.63	29.39	16.43	4.06
2500.0	18.71	23.34	28.37	17.50	1.12	0.64	28.79	16.05	4.13
2600.0	18.58	23.35	26.12	17.46	1.13	0.66	29.00	15.96	4.12
2700.0	18.43	23.39	24.60	17.49	1.14	0.67	28.92	15.88	4.08
2800.0	18.25	23.46	23.78	17.85	1.16	0.69	28.53	15.79	4.16
2900.0	18.12	23.41	22.37	17.53	1.16	0.70	28.29	15.65	4.13
3000.0	17.99	23.42	21.23	17.82	1.17	0.72	28.16	15.49	4.08
3100.0	17.85	23.54	20.58	17.99	1.19	0.73	28.00	15.31	4.10
3200.0	17.71	23.61	19.99	18.20	1.20	0.75	27.95	15.15	4.17
3300.0	17.57	23.62	19.30	17.92	1.21	0.76	27.70	15.30	4.13
3400.0	17.40	23.77	19.16	18.32	1.24	0.78	27.51	14.98	4.10
3500.0	17.29	23.77	18.39	17.93	1.24	0.79	27.09	14.69	4.26
3600.0	17.15	23.91	18.04	18.18	1.27	0.80	27.26	14.64	4.18
3800.0	16.93	24.02	17.08	17.86	1.29	0.82	26.85	14.23	4.26
4000.0	16.62	24.20	16.80	17.87	1.34	0.84	26.57	13.98	4.31
4200.0	16.46	24.41	15.78	17.41	1.37	0.86	25.95	13.42	4.36
4400.0	16.25	24.77	15.18	17.46	1.43	0.89	25.40	12.85	4.41
4600.0	15.83	24.80	15.61	17.59	1.50	0.90	25.11	12.54	4.51
4800.0	15.83	25.17	13.84	16.74	1.52	0.92	24.72	12.13	4.60
5000.0	15.61	25.53	13.41	16.77	1.59	0.94	23.95	11.64	4.68
5200.0	15.33	25.48	12.66	15.99	1.60	0.95	24.01	11.62	4.72
5400.0	15.29	26.11	12.73	16.80	1.72	0.97	23.19	11.09	4.88
5600.0	15.11	26.06	12.33	16.43	1.73	0.97	23.29	10.92	4.84
5800.0	14.97	26.52	11.16	14.86	1.77	1.00	22.79	10.64	4.92
6000.0	15.05	26.63	11.60	15.34	1.80	0.99	22.18	10.12	5.04

## Typical Performance Data

**Definitions:**

Input Return Loss = -S11 (dB)

Gain(Power Gain) = S21 (dB)

Reverse Isolation = -S12 (dB)

Output Return Loss = -S22 (dB)

TEST CONDITIONS: Vd = 5.5V, Id = 92.13 mA @ Temperature = +85degC

FREQ	Gain	Isolation	Input Return Loss	Output Return Loss	Stability		IP-3 Output	1dB Comp. Output	Noise Figure
					K	Measure			
(MHz)	(dB)	(dB)	(dB)	(dB)	K	Measure	(dBm)	(dBm)	(dB)
10.0	24.49	27.26	11.42	6.36	0.86	0.28	---	20.30	3.66
30.0	22.62	25.21	15.43	11.47	0.94	0.46	40.74	21.49	4.27
50.0	21.98	24.63	17.29	14.97	0.99	0.48	39.95	21.47	4.32
100.0	21.56	24.57	18.46	20.08	1.03	0.52	38.50	21.43	4.39
200.0	21.40	24.54	18.32	24.10	1.05	0.53	39.70	21.36	4.34
300.0	21.35	24.52	18.89	24.43	1.05	0.53	38.41	21.36	4.49
400.0	21.30	24.53	19.30	24.09	1.06	0.54	38.55	21.37	4.60
500.0	21.25	24.44	19.18	24.47	1.06	0.53	39.16	21.42	4.51
600.0	21.20	24.42	19.16	24.99	1.06	0.53	38.14	21.40	4.55
700.0	21.14	24.34	19.26	24.98	1.06	0.53	37.53	21.44	4.52
800.0	21.08	24.30	19.40	25.03	1.06	0.53	37.80	21.43	4.48
1000.0	20.92	24.21	19.68	24.90	1.07	0.53	35.16	21.40	4.53
1100.0	20.84	24.14	19.84	24.48	1.07	0.53	35.22	21.36	4.48
1200.0	20.74	24.04	20.12	23.79	1.07	0.53	35.25	21.28	4.49
1300.0	20.64	24.00	20.42	23.31	1.07	0.53	34.58	21.14	4.46
1400.0	20.53	23.93	20.89	22.62	1.07	0.54	33.67	20.99	4.54
1500.0	20.42	23.84	21.50	21.83	1.07	0.54	33.57	20.84	4.45
1600.0	20.28	23.83	22.33	21.30	1.08	0.55	33.29	20.67	4.45
1700.0	20.17	23.73	23.23	20.64	1.08	0.55	33.00	20.40	4.39
1800.0	20.04	23.68	24.30	20.03	1.08	0.55	32.37	20.14	4.52
1900.0	19.88	23.68	25.74	19.96	1.09	0.57	31.84	19.77	4.42
2000.0	19.72	23.62	27.50	19.81	1.10	0.58	31.68	19.46	4.46
2100.0	19.59	23.57	30.04	19.43	1.10	0.59	31.25	19.23	4.47
2200.0	19.45	23.56	33.35	19.23	1.11	0.60	30.92	18.95	4.45
2300.0	19.31	23.56	41.71	19.27	1.11	0.61	30.83	18.66	4.50
2400.0	19.16	23.49	42.40	19.30	1.12	0.62	30.38	18.48	4.53
2500.0	18.99	23.51	36.09	19.45	1.13	0.64	29.78	17.96	4.62
2600.0	18.85	23.52	30.86	19.41	1.14	0.65	29.68	17.77	4.55
2700.0	18.70	23.55	27.97	19.84	1.15	0.67	29.46	17.64	4.55
2800.0	18.51	23.61	26.32	20.41	1.16	0.69	29.21	17.48	4.66
2900.0	18.37	23.57	24.40	20.28	1.17	0.70	28.90	17.24	4.64
3000.0	18.24	23.61	22.72	21.02	1.18	0.71	28.65	17.06	4.59
3100.0	18.10	23.72	21.68	21.69	1.20	0.73	28.45	16.78	4.66
3200.0	17.95	23.82	20.85	22.32	1.22	0.75	28.29	16.55	4.66
3300.0	17.81	23.81	19.98	22.34	1.23	0.76	28.21	16.74	4.68
3400.0	17.63	23.95	19.67	23.17	1.25	0.78	27.79	16.30	4.67
3500.0	17.51	23.94	18.82	22.97	1.26	0.79	27.48	15.98	4.78
3600.0	17.37	24.13	18.28	23.77	1.29	0.81	27.50	15.89	4.75
3800.0	17.14	24.20	17.11	23.91	1.31	0.83	26.99	15.36	4.86
4000.0	16.81	24.46	16.71	24.34	1.37	0.85	26.65	15.04	4.94
4200.0	16.63	24.64	15.56	23.84	1.41	0.87	25.96	14.42	5.04
4400.0	16.40	24.99	14.86	24.03	1.47	0.90	25.39	13.81	5.09
4600.0	15.96	25.01	15.28	24.65	1.54	0.91	25.02	13.49	5.20
4800.0	15.94	25.47	13.41	22.59	1.57	0.94	24.65	13.06	5.34
5000.0	15.71	25.87	12.95	22.80	1.66	0.96	23.92	12.51	5.45
5200.0	15.39	25.76	12.17	21.41	1.67	0.97	24.06	12.57	5.51
5400.0	15.36	26.55	12.28	22.86	1.82	0.99	23.37	12.07	5.71
5600.0	15.16	26.56	11.76	22.15	1.84	1.00	23.23	11.85	5.67
5800.0	14.97	27.02	10.68	19.16	1.90	1.03	22.95	11.63	5.81
6000.0	15.04	27.22	11.00	19.76	1.95	1.02	22.35	11.13	5.92

## Typical Performance Curves

**GAIN vs. FREQUENCY & TEMPERATURE**  
INPUT POWER = -25dBm, Vd = 5V

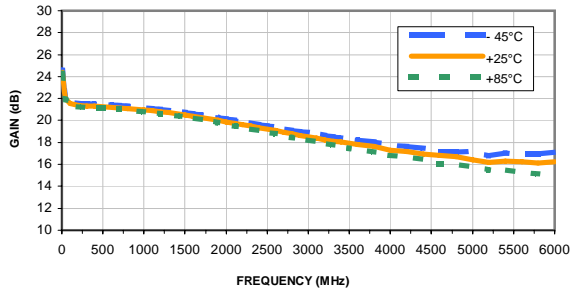

**GAIN vs. FREQUENCY & DEVICE VOLTAGE**  
INPUT POWER = -25dBm, Temperature = +25°C

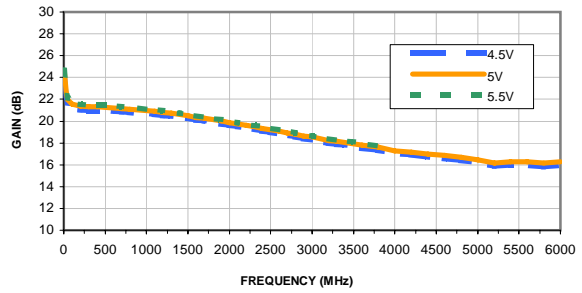

**ISOLATION vs. FREQUENCY & TEMPERATURE**  
INPUT POWER = -25dBm, Vd = 5V

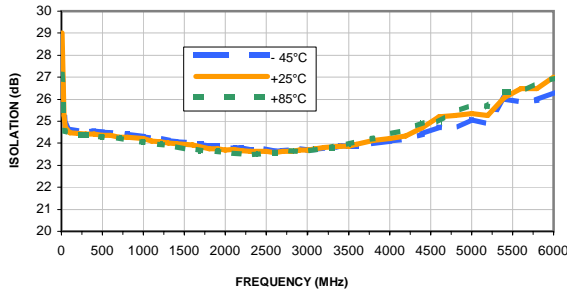

**ISOLATION vs. FREQUENCY & DEVICE VOLTAGE**  
INPUT POWER = -25dBm, Temperature = +25°C

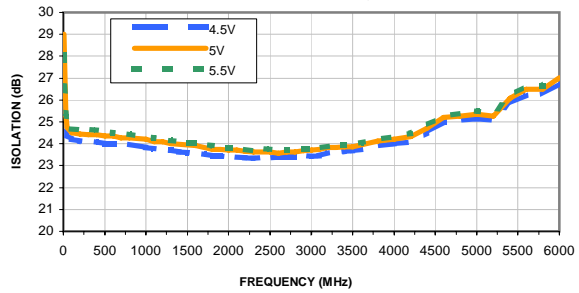

**INPUT RETURN LOSS vs. FREQUENCY & TEMPERATURE**  
INPUT POWER = -25dBm, Vd = 5V

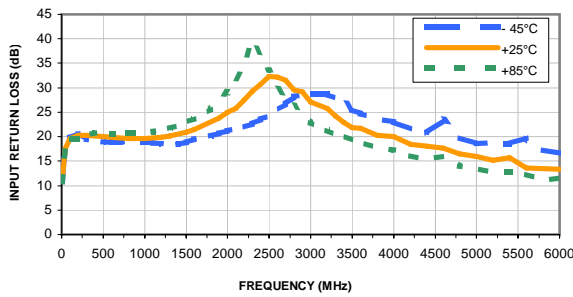

**INPUT RETURN LOSS vs. FREQUENCY & DEVICE VOLTAGE**  
INPUT POWER = -25dBm, Temperature = +25°C

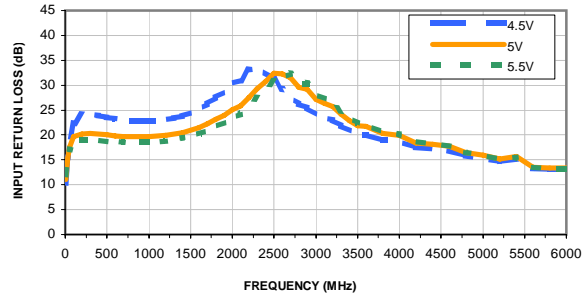

**OUTPUT RETURN LOSS vs. FREQUENCY & TEMPERATURE**  
INPUT POWER = -25dBm, Vd = 5V

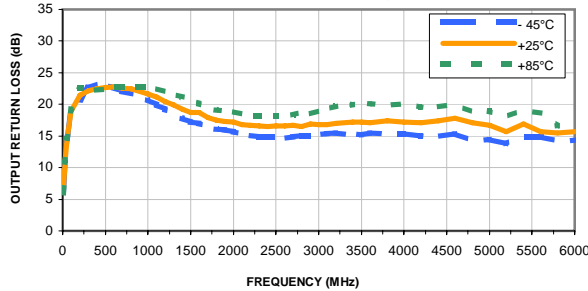

**OUTPUT RETURN LOSS vs. FREQUENCY & DEVICE VOLTAGE**  
INPUT POWER = -25dBm, Temperature = +25°C

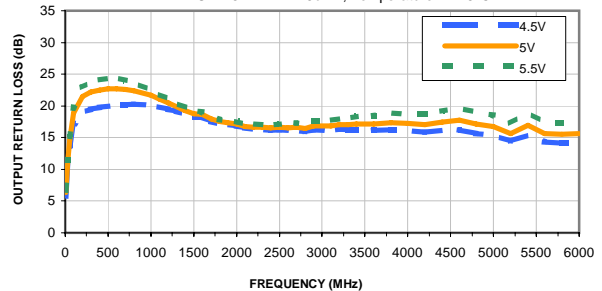



## Typical Performance Curves

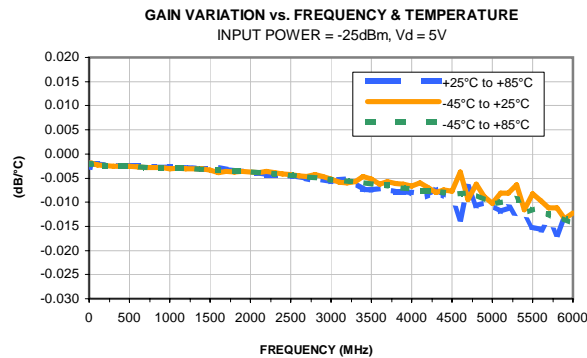
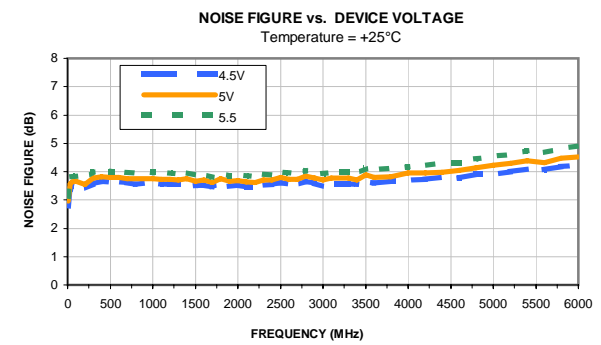
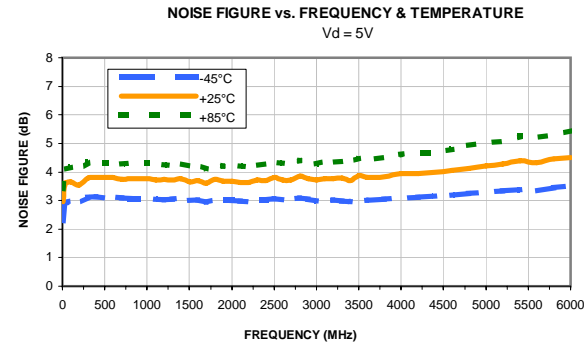
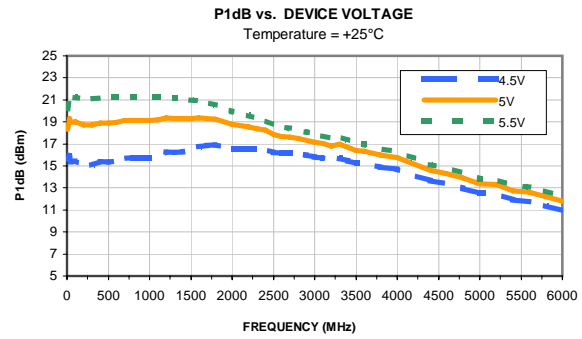
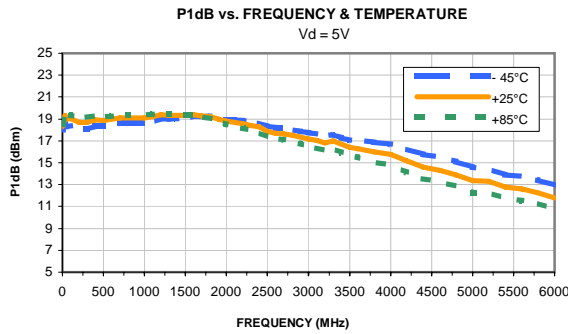
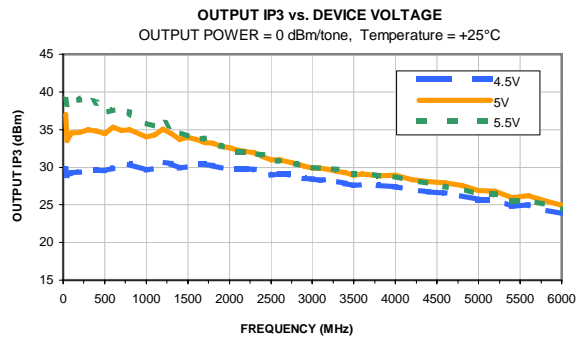
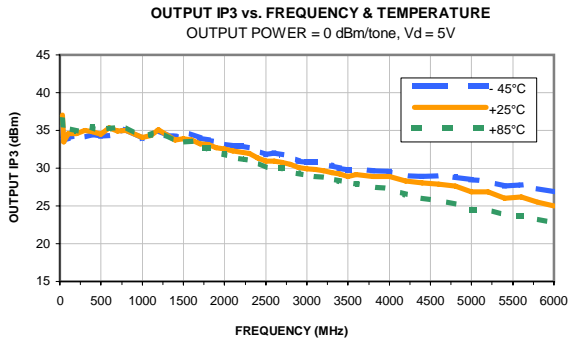



### Outline Dimensions

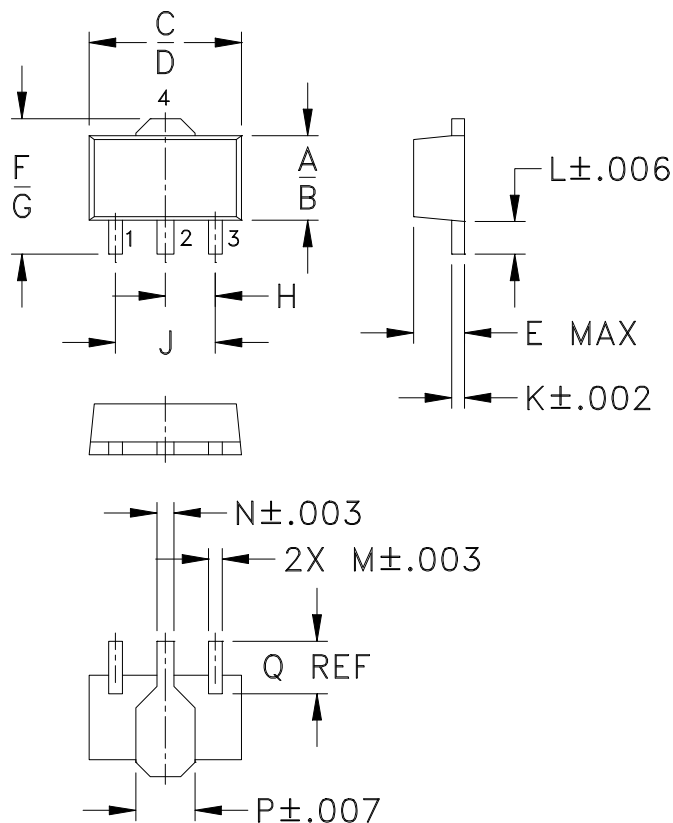

### PCB Land Pattern



Suggested Layout,  
Tolerance to be within  $\pm .002$

CASE #	A	B	C	D	E	F	G	H	J	K	L	M
DF782	.102 (2.59)	.090 (2.29)	.181 (4.60)	.173 (4.39)	.063 (1.60)	.167 (4.24)	.155 (3.94)	.059 (1.50)	.118 (3.00)	.015 (0.38)	.041 (1.04)	.016 (0.41)

CASE #	N	P	Q	WT. GRAM
DF782	.019 (0.48)	.065 (1.65)	.062 (1.57)	.2

Dimensions are in inches (mm). Tolerances: 2 Pl.  $\pm .01$ ; 3Pl.  $\pm .005$

#### Notes:

- Case material: Plastic.
- Termination finish:  
 For RoHS Case Styles: Tin-Silver alloy plate over Nickel barrier or Matte-Tin.  
 All models, (+) suffix. See model Data sheet.  
 For RoHS-5 Case Styles: Tin-Lead plate. All models, no (+) suffix.



INTERNET <http://www.minicircuits.com>

P.O. Box 350166, Brooklyn, New York 11235-0003 (718) 934-4500 Fax (718) 332-4661

Distribution Centers NORTH AMERICA 800-654-7949 • 417-335-5935 • Fax 417-335-5945 • EUROPE 44-1252-832600 • Fax 44-1252-837010

Mini-Circuits ISO 9001 & ISO 14001 Certified

# Tape & Reel Packaging TR-F55

## DEVICE ORIENTATION IN T&R

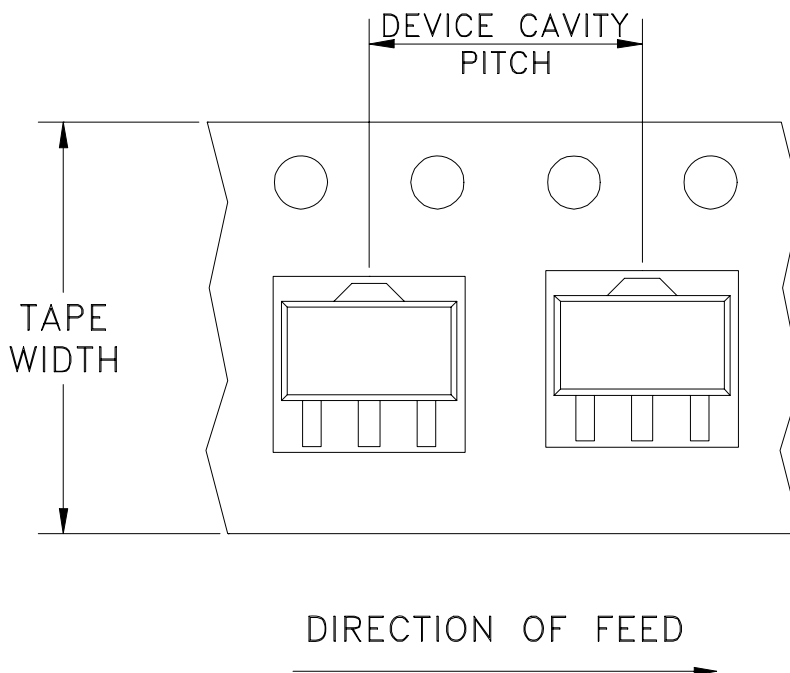

Tape Width, mm	Device Cavity Pitch, mm	Reel Size, inches	Devices per Reel	
12	8	7	Small quantity standard (see note)	20
				50
				100
				200
				500
			Standard	1000

Note: Please consult individual model data sheet to determine device per reel availability.

Mini-Circuits carrier tape materials provide protection from ESD (Electro-Static Discharge) during handling and transportation. Tapes are static dissipative and comply with industry standards EIA-481/EIA-541.

Go to: [www.minicircuits.com/pages/pdfs/tape.pdf](http://www.minicircuits.com/pages/pdfs/tape.pdf)



INTERNET <http://www.minicircuits.com>

P.O. Box 350166, Brooklyn, New York 11235-0003 (718) 934-4500 Fax (718) 332-4661

Distribution Centers NORTH AMERICA 800-654-7949 • 417-335-5935 • Fax 417-335-5945 • EUROPE 44-1252-832600 • Fax 44-1252-837010

Mini-Circuits ISO 9001 & ISO 14001 Certified

THIRD ANGLE PROJECTION

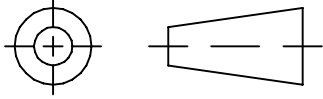

REVISIONS

REV	ECN No.	DESCRIPTION	DATE	DR	AUTH
OR	M108433	NEW RELEASE	11/14/06	PW	IG
A	M124803	"04AM03" WAS "mz", MODIFIED TB IN TITLE	10/23/09	MMG	DJ

**SUGGESTED MOUNTING CONFIGURATION  
FOR DF782 CASE STYLE, "04AM03" PIN CONNECTION**

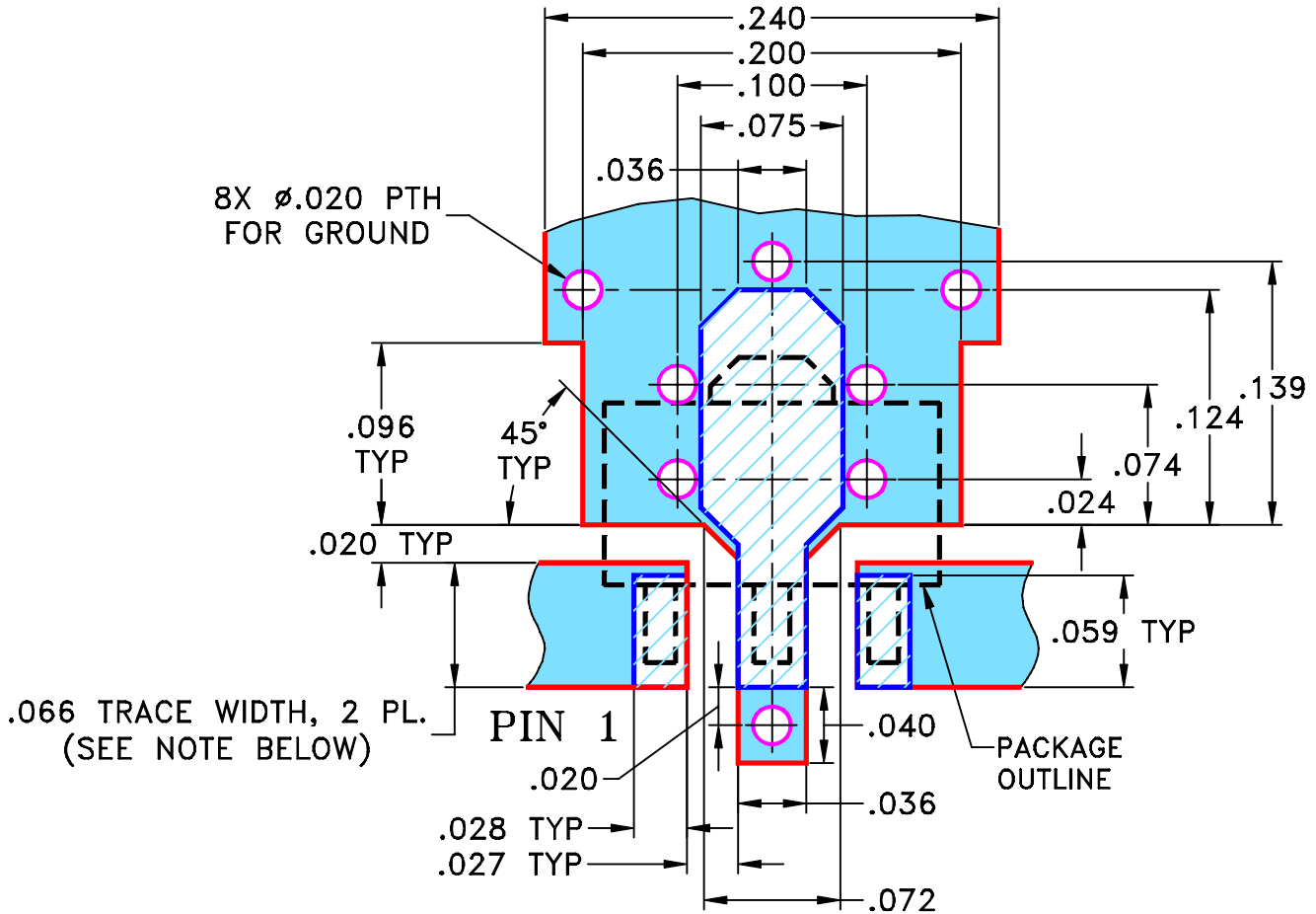

- NOTES:** 1. TRACE WIDTH IS SHOWN FOR ROGERS RO4350B WITH DIELECTRIC THICKNESS .030" ± .002"; COPPER: 1/2 OZ. EACH SIDE. FOR OTHER MATERIALS TRACE WIDTH MAY NEED TO BE MODIFIED.  
2. BOTTOM SIDE OF THE PCB IS CONTINUOUS GROUND PLANE.



DENOTES PCB COPPER LAYOUT WITH SMOBC (SOLDER MASK OVER BARE COPPER)



DENOTES COPPER LAND PATTERN FREE OF SOLDER MASK

UNLESS OTHERWISE SPECIFIED	INITIALS	DATE
DIMENSIONS ARE IN INCHES	DRAWN PW	11/14/06
TOLERANCES ON:	CHECKED IL	11/14/06
2 PL DECIMALS ±	APPROVED IG	11/14/06
3 PL DECIMALS ± .005		
ANGLES ±		
FRACTIONS ±		

**Mini-Circuits®** 13 Neptune Avenue  
Brooklyn NY 11235

PL, 04AM03, DF782, GVA, TB-410-XX+

**Mini-Circuits®**  
THIS DOCUMENT AND ITS CONTENTS ARE THE PROPERTY OF MINI-CIRCUITS. EXCEPT FOR USE EXPRESSLY GRANTED, IN WRITING, TO ITS VENDORS, VENDEE AND THE UNITED STATES GOVERNMENT, MINI-CIRCUITS RESERVES ALL PROPRIETARY DESIGN, USE, MANUFACTURING AND REPRODUCTION RIGHTS THERETO. THESE CONTENTS SHALL NOT BE USED, DUPLICATED OR DISCLOSED TO ANY OUTSIDE PARTY, IN WHOLE OR IN PART, WITHOUT WRITTEN PERMISSION OF MINI-CIRCUITS.

SIZE	CODE IDENT	DRAWING NO:	REV:
A	15542	98-PL-255	A
FILE: 98PL255	SCALE: 10:1	SHEET: 1	OF 1

# Evaluation Board and Circuit

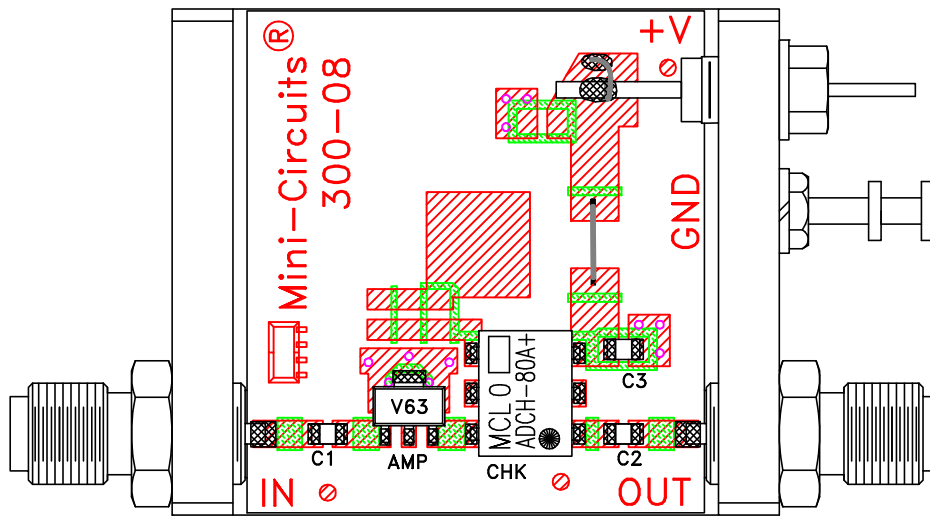

TB-410-63+

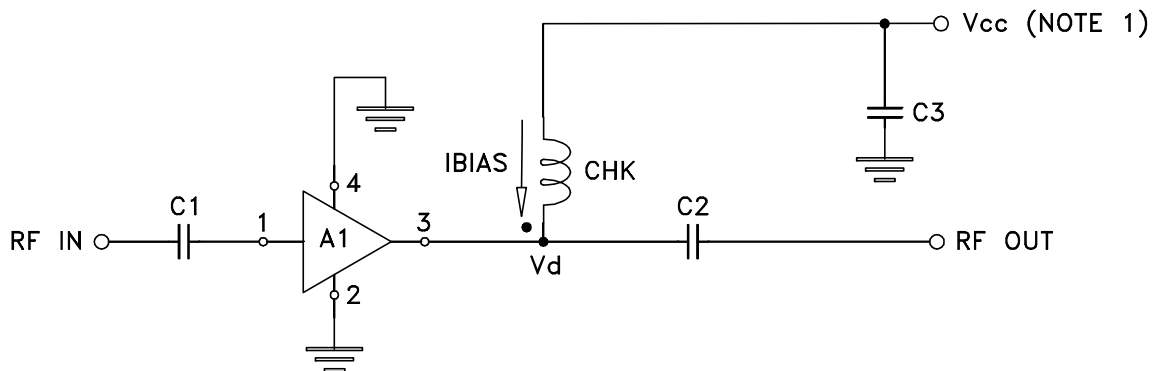

COMPONENT	VALUE
A1	GVA-63+
C1 (NOTE 4)	2400 pF
C2 (NOTE 4)	2400 pF
C3 (bypass)	0.1 uF
CHK	Mini-Circuits ADCH-80A+

Schematic Diagram

- NOTE:**
1. Vcc voltage:  $+5 \pm 0.2V$ .
  2. SMA Female connectors.
  3. PCB material: Rogers R04350 or equivalent, dielectric constant=3.5, dielectric thickness=.030 inch.
  4. Capacitors, C1 & C2 should be free of resonance up to the highest frequency specified.

 **Mini-Circuits®**

All Mini-Circuits products are manufactured under exacting quality assurance and control standards, and are capable of meeting published specifications after being subjected to any or all of the following physical and environmental test.

Specification	Test/Inspection Condition	Reference/Spec
Operating Temperature	-40° to 85°C Ambient Environment	Individual Model Data Sheet
Storage Temperature	-55° to 100° C or -65° to 150° Ambient Environment	Individual Model Data Sheet
Thermal Shock	-55° to 100°C, 100 cycles	MIL-STD-202, Method 107, Condition A-3, except +100°C
Mechanical Shock	1.5Kg, 0.5 ms, 5 shock pulses, Y1 direction only	MIL-STD-883, Method 2002, Condition B, except Y1 direction only
Vibration (Variable Frequency)	50g peak	MIL-STD-883, Method 2007, Condition B
Autoclave	15 psig, 100% RH, 121°C, 96 hours	JESD22-A102, Condition C
HAST	130°C, 85% RH, 96 hours	JESD22-A110
Solderability	10X Magnification	J-STD-002, Para 4.2.5, Test S, 95% Coverage
Solder Reflow Heat	Sn-Pb Eutetic Process: 240°C peak Pb-Free Process: 260°C peak	J-STD-020, Table 4-1, 4-2 and 5-2; Figure 5-1
Moisture Sensitivity: Level 1	Bake at 125°C for 24 hours Soak at 85°C/85% RH for 168 hours, Reflow 3 cycles at 260°C peak	J-STD-020
Marking Resistance to Solvents	Isopropyl alcohol + mineral spirits at 25°C; terpene defluxer at 25°C; distilled water + proylene glycol monomethyl ether +	MIL-STD-202, Method 215



All Mini-Circuits products are manufactured under exacting quality assurance and control standards, and are capable of meeting published specifications after being subjected to any or all of the following physical and environmental test.

Specification	Test/Inspection Condition	Reference/Spec
---------------	---------------------------	----------------

monoethanolamine at 63°C to 70°C