

2SC4981 (TP7S8)

7A NPN

OUTLINE DIMENSIONS

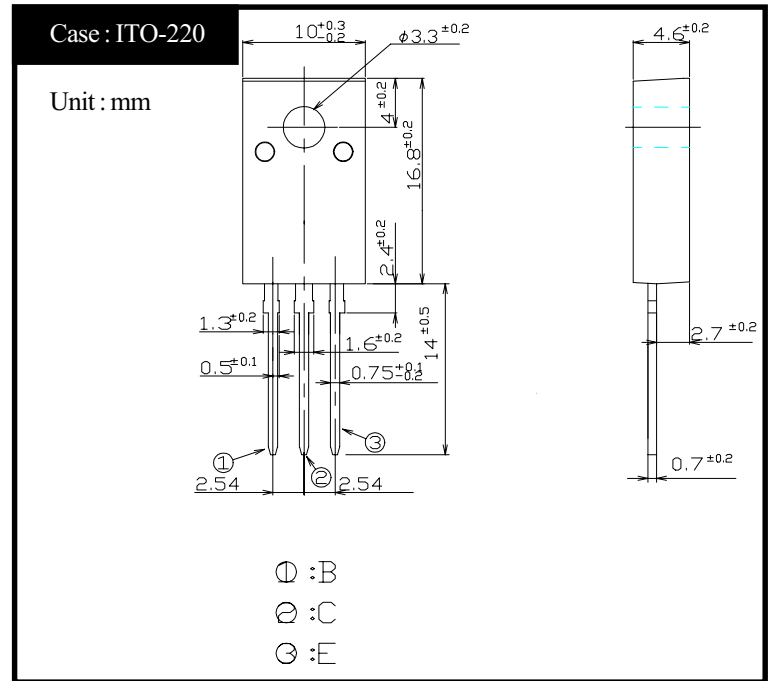

RATINGS

● Absolute Maximum Ratings

Item	Symbol	Conditions	Ratings	Unit
Storage Temperature	T_{stg}		-55 ~ 150	°C
Junction Temperature	T_j		150	°C
Collector to Base Voltage	V_{CBO}		100	V
Collector to Emitter Voltage	V_{CEO}		80	V
Emitter to Base Voltage	V_{EBO}		7	V
Collector Current DC	I_C		7	A
Collector Current Peak	I_{CP}		14	A
Base Current DC	I_B		1.5	A
Base Current Peak	I_{BP}		2	A
Total Transistor Dissipation	P_T	$T_c = 25^\circ\text{C}$	25	W
Dielectric Strength	V_{dis}	Terminal to case, AC 1 minute	2	kV
Mounting Torque	TOR	(Recommended torque : 0.3N·m)	0.5	N·m

● Electrical Characteristics ($T_c=25^\circ\text{C}$)

Item	Symbol	Conditions	Ratings	Unit
Collector to Emitter Sustaining Voltage	$V_{CEO(sus)}$	$I_C = 0.1A$	Min 80	V
Collector Cutoff Current	I_{CBO}	At rated Voltage	Max 0.1	mA
	I_{CEO}		Max 0.1	
Emitter Cutoff Current	I_{EBO}	At rated Voltage	Max 0.1	mA
DC Current Gain	h_{FE}	$V_{CE} = 2V, I_C = 3.5A$	Min 70	
Collector to Emitter Saturation Voltage	$V_{CE(sat)}$	$I_C = 3.5A$	Max 0.3	V
Base to Emitter Saturation Voltage	$V_{BE(sat)}$	$I_B = 0.2A$	Max 1.2	V
Thermal Resistance	θ_{jc}	Junction to case	Max 5	°C/W
Transition Frequency	f_T	$V_{CE} = 10V, I_C = 0.7A$	TYP 50	MHz
Turn on Time	t_{on}	$I_C = 3.5A$ $I_{B1} = 0.35A, I_{B2} = 0.35A$ $R_L = 8\Omega, V_{BB2} = 4V$	Max 0.3	μs
Storage Time	t_s		Max 1.5	
Fall Time	t_f		Max 0.2	

2SC4981 $h_{FE} - I_C$

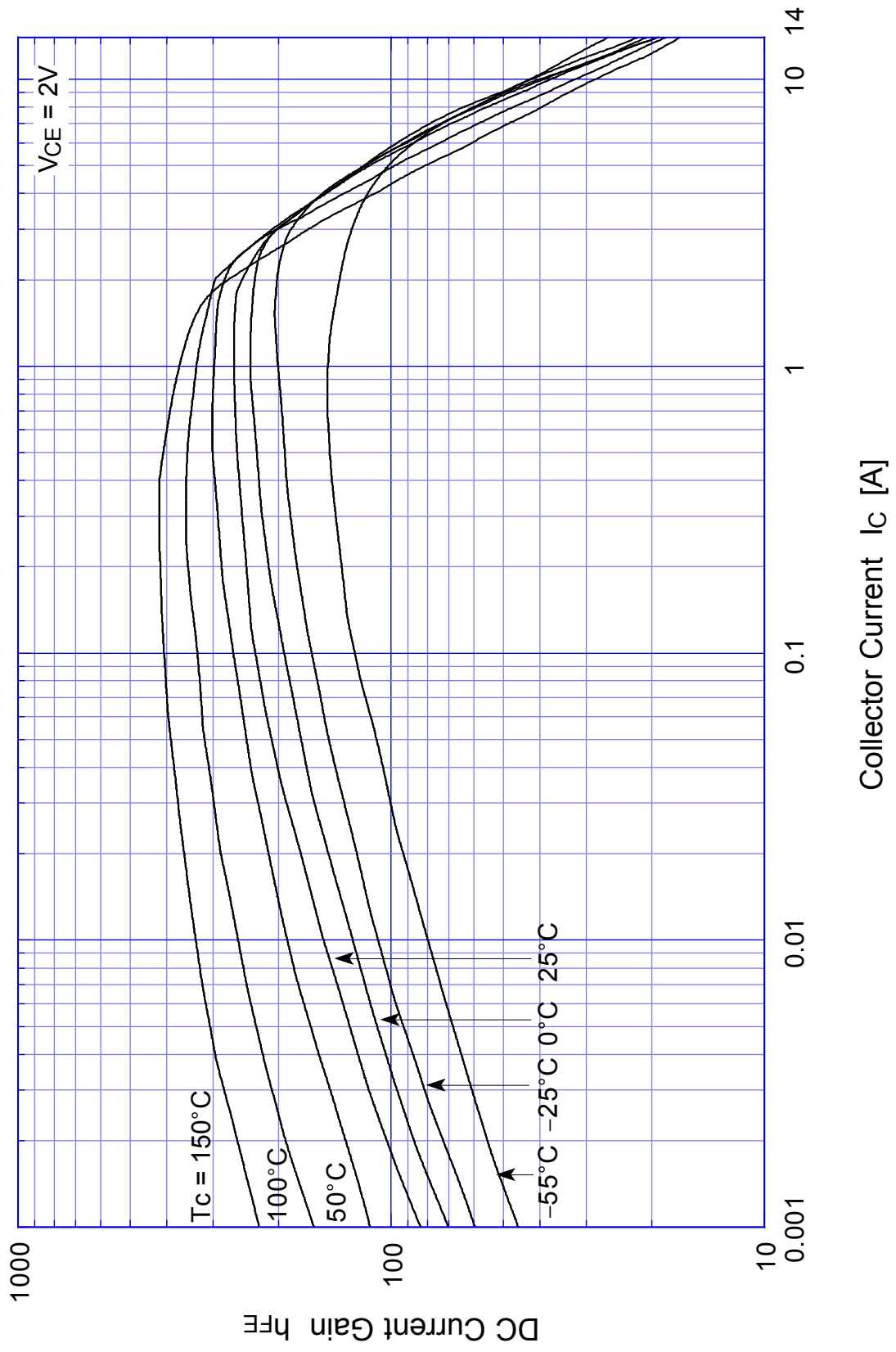

2SC4981 Saturation Voltage

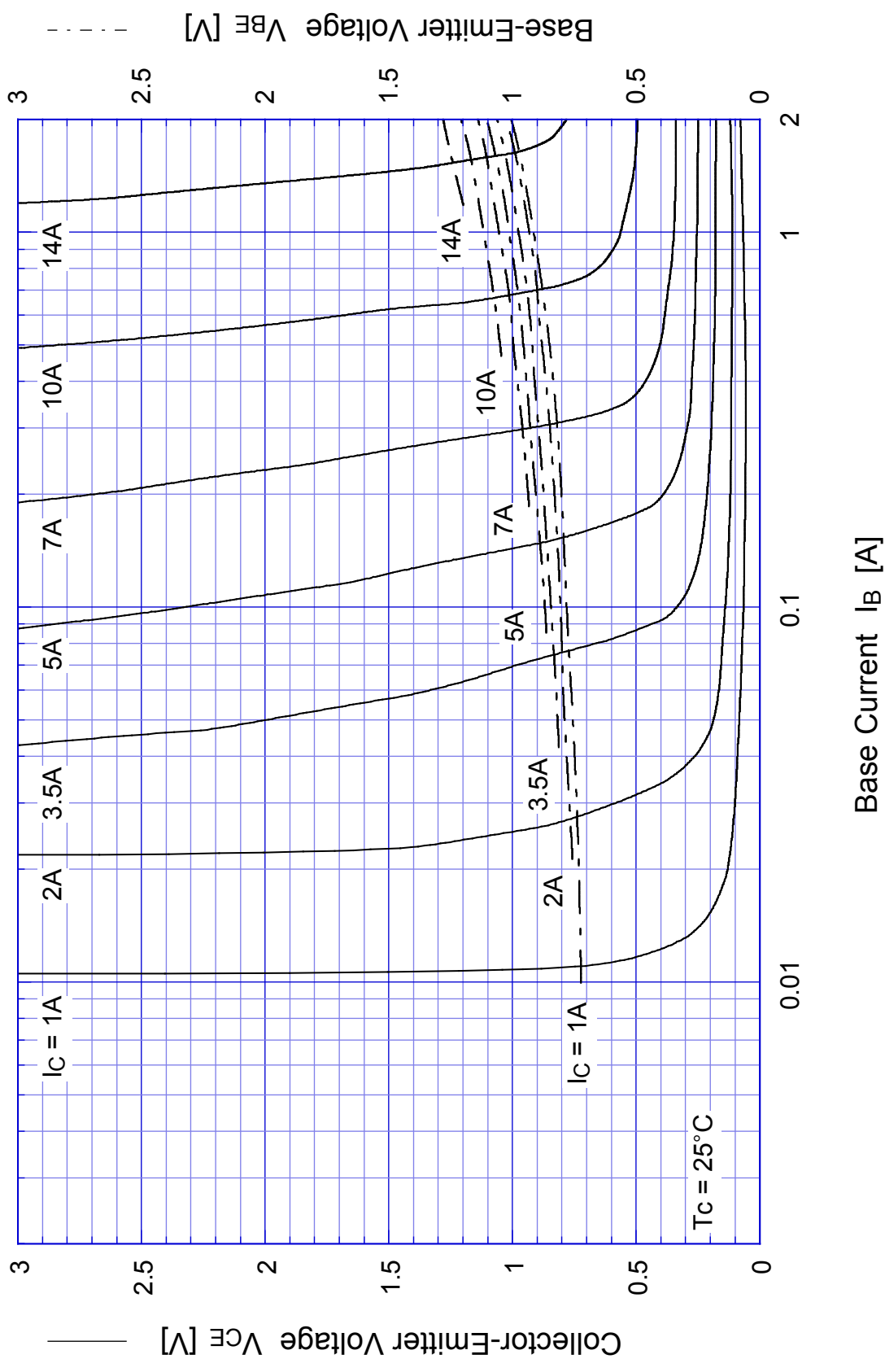

2SC4981

Switching Time - I_C

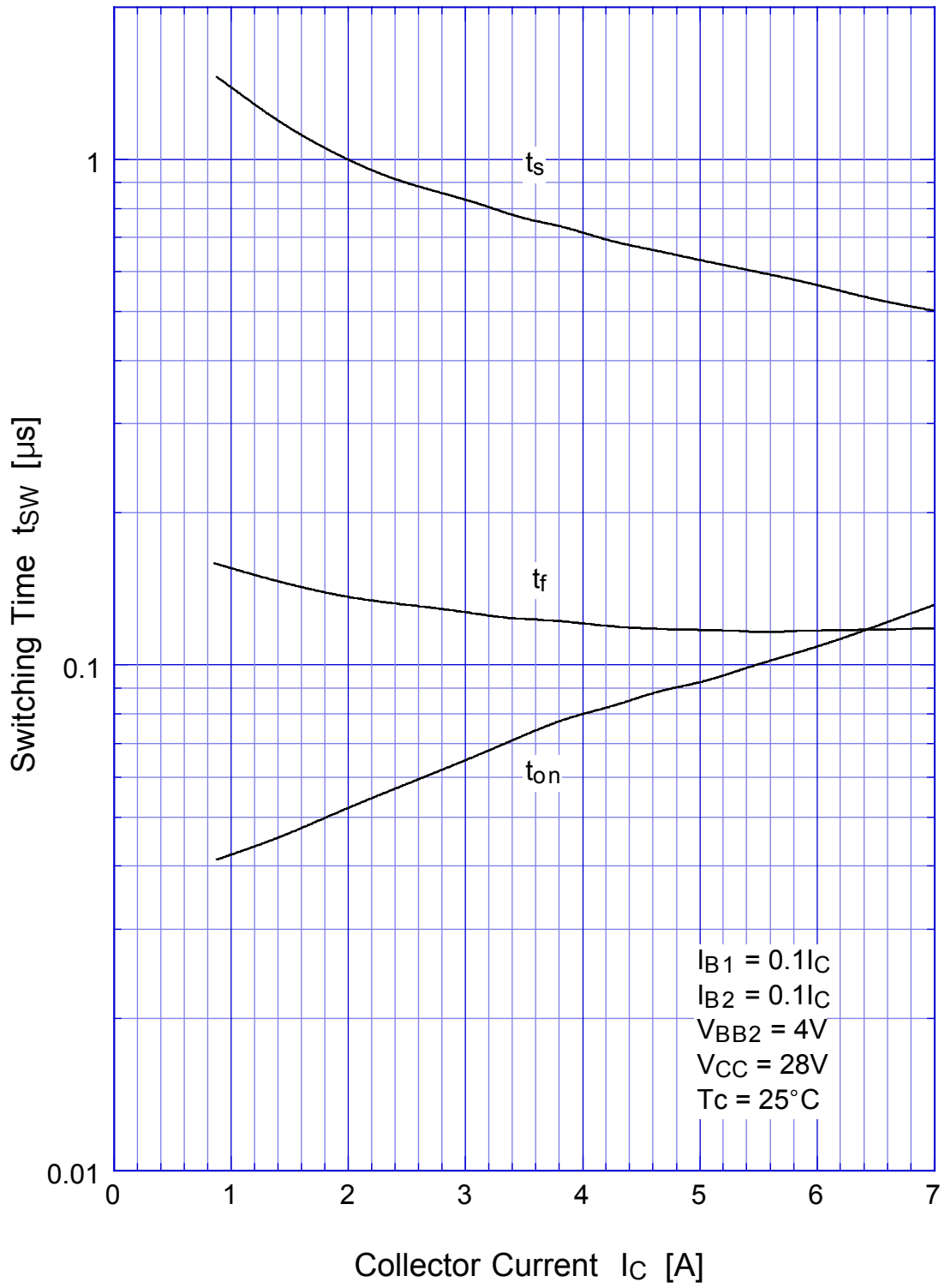

2SC4981

Switching Time - Tc

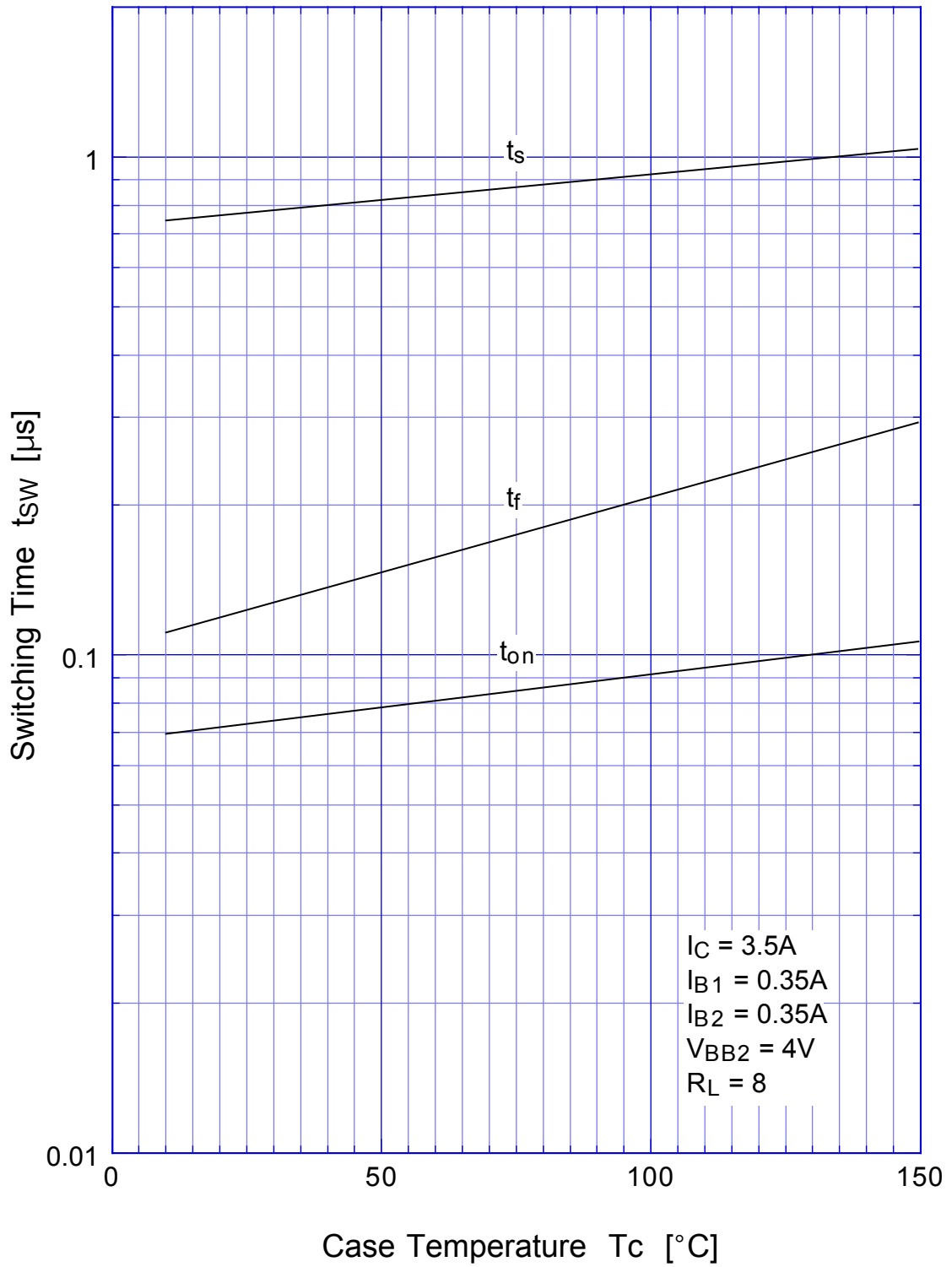

2SC4981 Transient Thermal Impedance

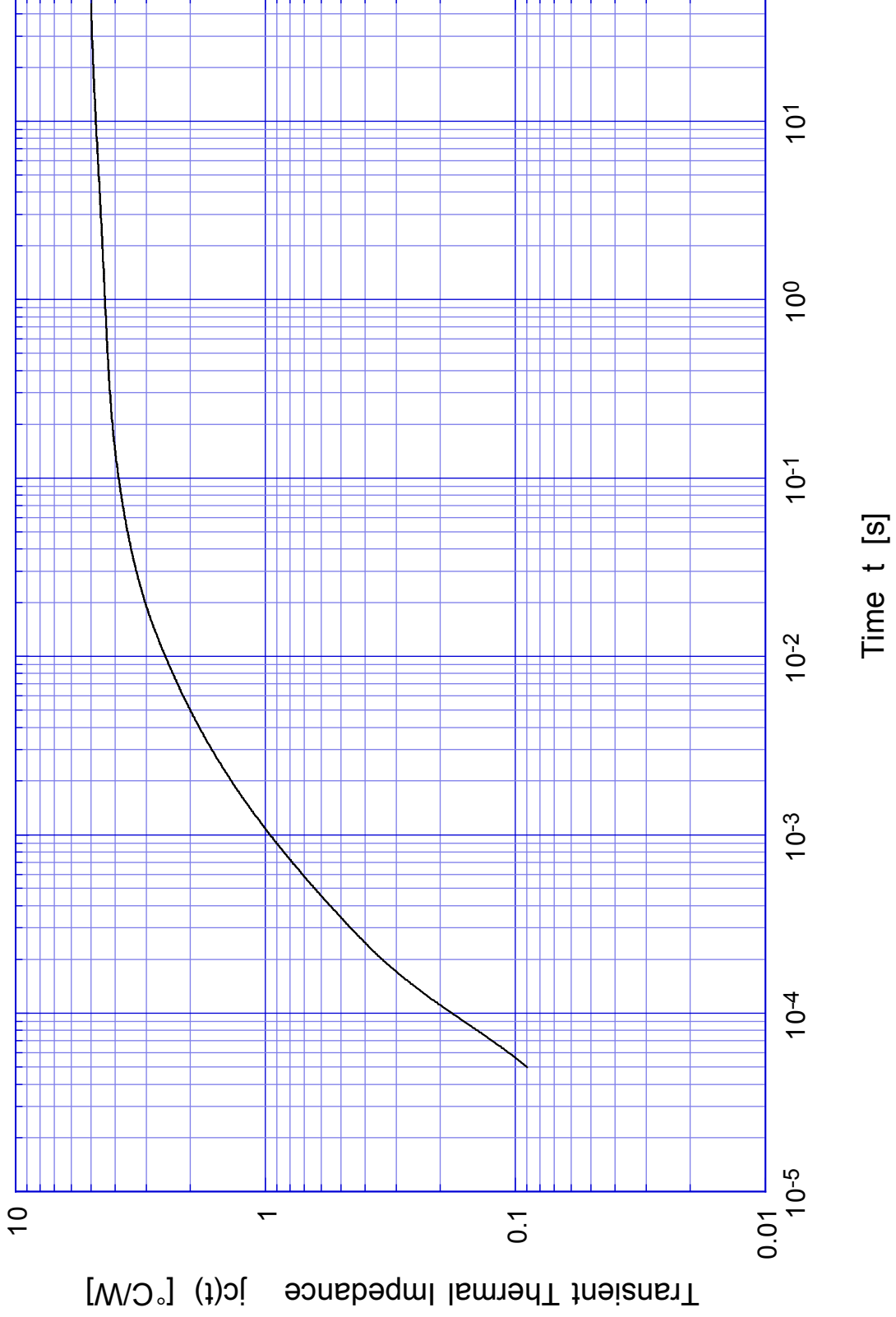

2SC4981

Forward Bias SOA

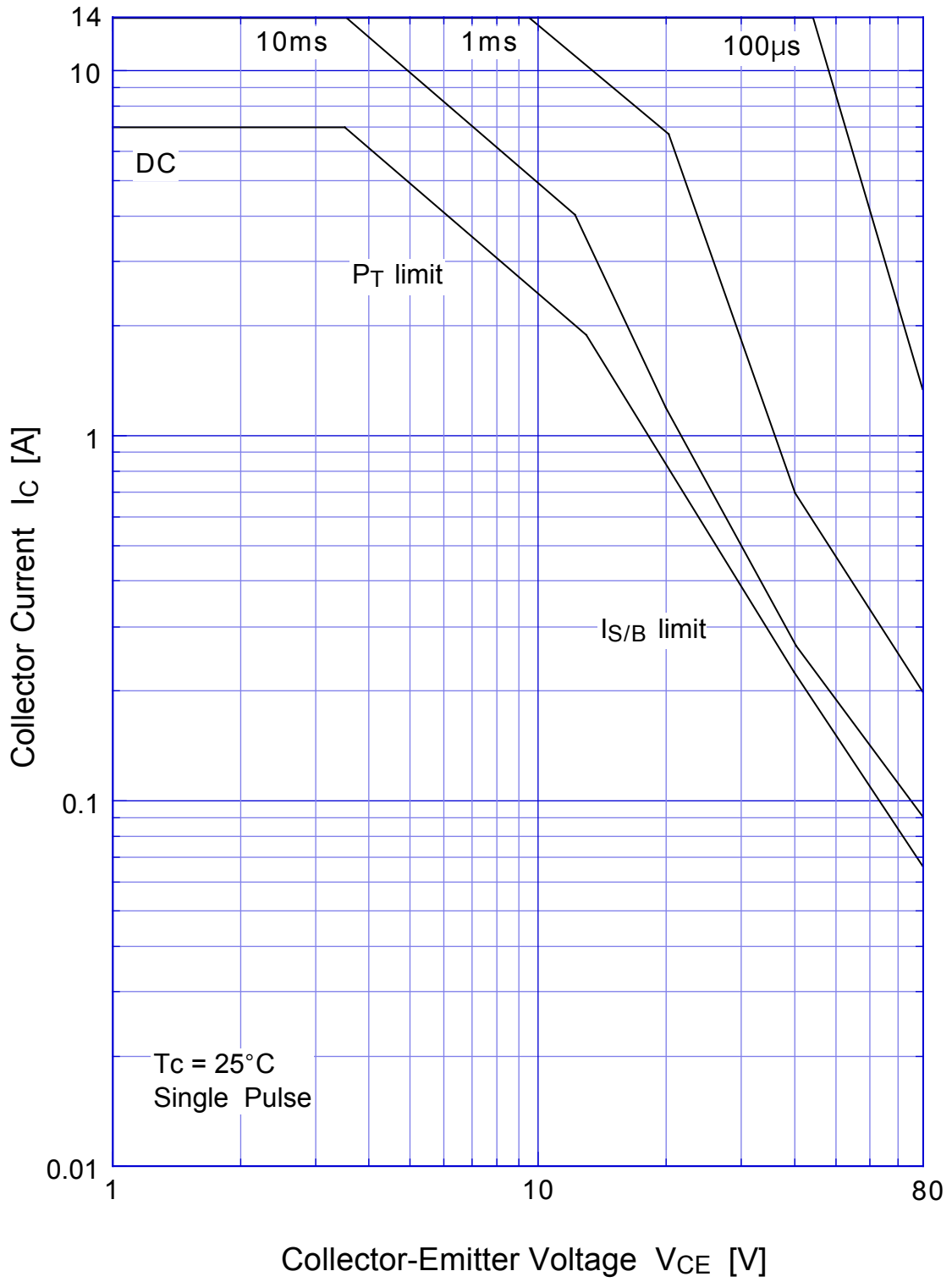

2SC4981 Collector Current Derating

