

## COMPLEMENTARY NPN / PNP SMALL SIGNAL SURFACE MOUNT TRANSISTOR

### Features

- Complementary Pair
- One 3904-Type NPN,  
One 3906-Type PNP
- Epitaxial Planar Die Construction
- Ideal for Low Power Amplification and Switching
- Ultra-Small Surface Mount Package
- **Available in Lead Free/RoHS Compliant Version (Note 3)**

### Mechanical Data

- Case: SOT-363
- Case Material: Molded Plastic. UL Flammability Classification Rating 94V-0
- Moisture Sensitivity: Level 1 per J-STD-020C
- Terminals: Solderable per MIL-STD-202, Method 208
- Also Available in Lead Free Plating (Matte Tin Finish annealed over Alloy 42 leadframe). Please see Ordering Information, Note 6, on Page 3
- Terminal Connections: See Diagram
- Marking (See Page 2): K46
- Ordering & Date Code Information: See Page 2
- Weight: 0.006 grams (approx.)

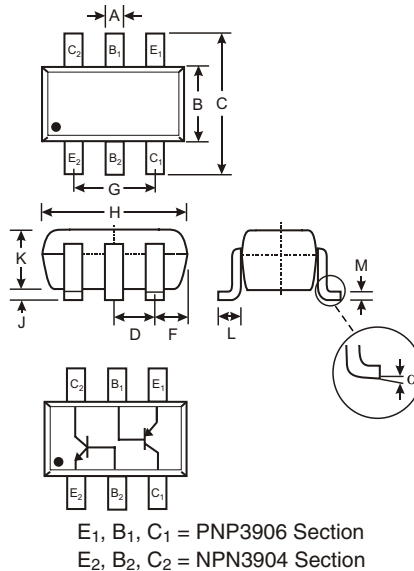

SOT-363		
Dim	Min	Max
A	0.10	0.30
B	1.15	1.35
C	2.00	2.20
D	0.65 Nominal	
F	0.30	0.40
H	1.80	2.20
J	—	0.10
K	0.90	1.00
L	0.25	0.40
M	0.10	0.25
α	0°	8°
<b>All Dimensions in mm</b>		

### Maximum Ratings, NPN 3904 Section @ T<sub>A</sub> = 25°C unless otherwise specified

Characteristic	Symbol	NPN 3904 Section	Unit
Collector-Base Voltage	V <sub>CBO</sub>	60	V
Collector-Emitter Voltage	V <sub>CEO</sub>	40	V
Emitter-Base Voltage	V <sub>EBO</sub>	6.0	V
Collector Current - Continuous (Note 1, 2)	I <sub>C</sub>	200	mA
Power Dissipation (Note 1)	P <sub>d</sub>	200	mW
Thermal Resistance, Junction to Ambient (Note 1)	R <sub>θJA</sub>	625	°C/W

### Maximum Ratings, PNP 3906 Section @ T<sub>A</sub> = 25°C unless otherwise specified

Characteristic	Symbol	PNP 3906 Section	Unit
Collector-Base Voltage	V <sub>CBO</sub>	-40	V
Collector-Emitter Voltage	V <sub>CEO</sub>	-40	V
Emitter-Base Voltage	V <sub>EBO</sub>	-5.0	V
Collector Current - Continuous (Note 1)	I <sub>C</sub>	-200	mA
Power Dissipation (Note 1, 2)	P <sub>d</sub>	200	mW
Thermal Resistance, Junction to Ambient (Note 1)	R <sub>θJA</sub>	625	°C/W

- Notes:
1. Device mounted on FR-4 PCB, 1 inch x 0.85 inch x 0.062 inch; pad layout as shown on Diodes Inc. suggested pad layout document AP02001, which can be found on our website at <http://www.diodes.com/datasheets/ap02001.pdf>.
  2. Maximum combined dissipation.
  3. No purposefully added lead.

**Electrical Characteristics, NPN 3904 Section**

 @  $T_A = 25^\circ\text{C}$  unless otherwise specified

Characteristic	Symbol	Min	Max	Unit	Test Condition
<b>OFF CHARACTERISTICS (Note 4)</b>					
Collector-Base Breakdown Voltage	$V_{(BR)CBO}$	60	—	V	$I_C = 10\mu\text{A}, I_E = 0$
Collector-Emitter Breakdown Voltage	$V_{(BR)CEO}$	40	—	V	$I_C = 1.0\text{mA}, I_B = 0$
Emitter-Base Breakdown Voltage	$V_{(BR)EBO}$	5.0	6.0	V	$I_E = 10\mu\text{A}, I_C = 0$
Collector Cutoff Current	$I_{CEX}$	—	50	nA	$V_{CE} = 30\text{V}, V_{EB(OFF)} = 3.0\text{V}$
Base Cutoff Current	$I_{BL}$	—	50	nA	$V_{CE} = 30\text{V}, V_{EB(OFF)} = 3.0\text{V}$
<b>ON CHARACTERISTICS (Note 4)</b>					
DC Current Gain	$h_{FE}$	40 70 100 60 30	— — 300 — —	—	$I_C = 100\mu\text{A}, V_{CE} = 1.0\text{V}$ $I_C = 1.0\text{mA}, V_{CE} = 1.0\text{V}$ $I_C = 10\text{mA}, V_{CE} = 1.0\text{V}$ $I_C = 50\text{mA}, V_{CE} = 1.0\text{V}$ $I_C = 100\text{mA}, V_{CE} = 1.0\text{V}$
Collector-Emitter Saturation Voltage	$V_{CE(SAT)}$	—	0.20 0.30	V	$I_C = 10\text{mA}, I_B = 1.0\text{mA}$ $I_C = 50\text{mA}, I_B = 5.0\text{mA}$
Base-Emitter Saturation Voltage	$V_{BE(SAT)}$	0.65 —	0.85 0.95	V	$I_C = 10\text{mA}, I_B = 1.0\text{mA}$ $I_C = 50\text{mA}, I_B = 5.0\text{mA}$
<b>SMALL SIGNAL CHARACTERISTICS</b>					
Output Capacitance	$C_{obo}$	—	4.0	pF	$V_{CB} = 5.0\text{V}, f = 1.0\text{MHz}, I_E = 0$
Input Capacitance	$C_{ibo}$	—	8.0	pF	$V_{EB} = 0.5\text{V}, f = 1.0\text{MHz}, I_C = 0$
Input Impedance	$h_{ie}$	1.0	10	k $\Omega$	$V_{CE} = 10\text{V}, I_C = 1.0\text{mA}, f = 1.0\text{kHz}$
Voltage Feedback Ratio	$h_{re}$	0.5	8.0	$\times 10^{-4}$	
Small Signal Current Gain	$h_{fe}$	100	400	—	
Output Admittance	$h_{oe}$	1.0	40	$\mu\text{S}$	
Current Gain-Bandwidth Product	$f_T$	300	—	MHz	
Noise Figure	NF	—	5.0	dB	$V_{CE} = 5.0\text{V}, I_C = 100\mu\text{A}, R_S = 1.0\text{k}\Omega, f = 1.0\text{kHz}$
<b>SWITCHING CHARACTERISTICS</b>					
Delay Time	$t_d$	—	35	ns	$V_{CC} = 3.0\text{V}, I_C = 10\text{mA}, V_{BE(off)} = -0.5\text{V}, I_{B1} = 1.0\text{mA}$
Rise Time	$t_r$	—	35	ns	
Storage Time	$t_s$	—	200	ns	$V_{CC} = 3.0\text{V}, I_C = 10\text{mA}, I_{B1} = I_{B2} = 1.0\text{mA}$
Fall Time	$t_f$	—	50	ns	

Note: 4. Short duration test pulse used to minimize self-heating effect.

## Electrical Characteristics, PNP 3906 Section

@ T<sub>A</sub> = 25°C unless otherwise specified

Characteristic	Symbol	Min	Max	Unit	Test Condition
<b>OFF CHARACTERISTICS (Note 4)</b>					
Collector-Base Breakdown Voltage	V <sub>(BR)CBO</sub>	-40	—	V	I <sub>C</sub> = -10μA, I <sub>E</sub> = 0
Collector-Emitter Breakdown Voltage	V <sub>(BR)CEO</sub>	-40	—	V	I <sub>C</sub> = -1.0mA, I <sub>B</sub> = 0
Emitter-Base Breakdown Voltage	V <sub>(BR)EBO</sub>	-5.0	—	V	I <sub>E</sub> = -10μA, I <sub>C</sub> = 0
Collector Cutoff Current	I <sub>CEX</sub>	—	-50	nA	V <sub>CE</sub> = -30V, V <sub>EB(OFF)</sub> = -3.0V
Base Cutoff Current	I <sub>BL</sub>	—	-50	nA	V <sub>CE</sub> = -30V, V <sub>EB(OFF)</sub> = -3.0V
<b>ON CHARACTERISTICS (Note 4)</b>					
DC Current Gain	h <sub>FE</sub>	60 80 100 60 30	— — 300 — —	—	I <sub>C</sub> = -100μA, V <sub>CE</sub> = -1.0V I <sub>C</sub> = -1.0mA, V <sub>CE</sub> = -1.0V I <sub>C</sub> = -10mA, V <sub>CE</sub> = -1.0V I <sub>C</sub> = -50mA, V <sub>CE</sub> = -1.0V I <sub>C</sub> = -100mA, V <sub>CE</sub> = -1.0V
Collector-Emitter Saturation Voltage	V <sub>CE(SAT)</sub>	—	-0.25 -0.40	V	I <sub>C</sub> = -10mA, I <sub>B</sub> = -1.0mA I <sub>C</sub> = -50mA, I <sub>B</sub> = -5.0mA
Base-Emitter Saturation Voltage	V <sub>BE(SAT)</sub>	-0.65 —	-0.85 -0.95	V	I <sub>C</sub> = -10mA, I <sub>B</sub> = -1.0mA I <sub>C</sub> = -50mA, I <sub>B</sub> = -5.0mA
<b>SMALL SIGNAL CHARACTERISTICS</b>					
Output Capacitance	C <sub>obo</sub>	—	4.5	pF	V <sub>CB</sub> = -5.0V, f = 1.0MHz, I <sub>E</sub> = 0
Input Capacitance	C <sub>ibo</sub>	—	10	pF	V <sub>EB</sub> = -0.5V, f = 1.0MHz, I <sub>C</sub> = 0
Input Impedance	h <sub>ie</sub>	2.0	12	kΩ	V <sub>CE</sub> = 10V, I <sub>C</sub> = 1.0mA, f = 1.0kHz
Voltage Feedback Ratio	h <sub>re</sub>	0.1	10	x 10 <sup>-4</sup>	
Small Signal Current Gain	h <sub>fe</sub>	100	400	—	
Output Admittance	h <sub>oe</sub>	3.0	60	μS	
Current Gain-Bandwidth Product	f <sub>T</sub>	250	—	MHz	V <sub>CE</sub> = -20V, I <sub>C</sub> = -10mA, f = 100MHz
Noise Figure	NF	—	4.0	dB	V <sub>CE</sub> = -5.0V, I <sub>C</sub> = -100μA, R <sub>S</sub> = 1.0kΩ, f = 1.0kHz
<b>SWITCHING CHARACTERISTICS</b>					
Delay Time	t <sub>d</sub>	—	35	ns	V <sub>CC</sub> = -3.0V, I <sub>C</sub> = -10mA, V <sub>BE(off)</sub> = 0.5V, I <sub>B1</sub> = -1.0mA
Rise Time	t <sub>r</sub>	—	35	ns	
Storage Time	t <sub>s</sub>	—	225	ns	V <sub>CC</sub> = -3.0V, I <sub>C</sub> = -10mA, I <sub>B1</sub> = I <sub>B2</sub> = -1.0mA
Fall Time	t <sub>f</sub>	—	75	ns	

## Ordering Information (Note 5)

Device	Packaging	Shipping
MMDT3946-7	SOT-363	3000/Tape & Reel

- Notes:
4. Short duration test pulse used to minimize self-heating effect.
  5. For Packaging Details, go to our website at <http://www.diodes.com/datasheets/ap02007.pdf>.
  6. For Lead Free/RoHS Compliant version part number, please add "-F" suffix to the part number above. Example: MMDT3946-7-F.

## Marking Information

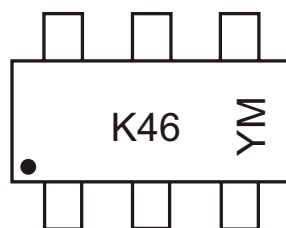

K46 = Product Type Marking Code  
 YM = Date Code Marking  
 Y = Year ex: N = 2002  
 M = Month ex: 9 = September

### Date Code Key

Year	1998	1999	2000	2001	2002	2003	2004	2005	2006	2007	2008	2009
Code	J	K	L	M	N	P	R	S	T	U	V	W

Month	Jan	Feb	March	Apr	May	Jun	Jul	Aug	Sep	Oct	Nov	Dec
Code	1	2	3	4	5	6	7	8	9	O	N	D

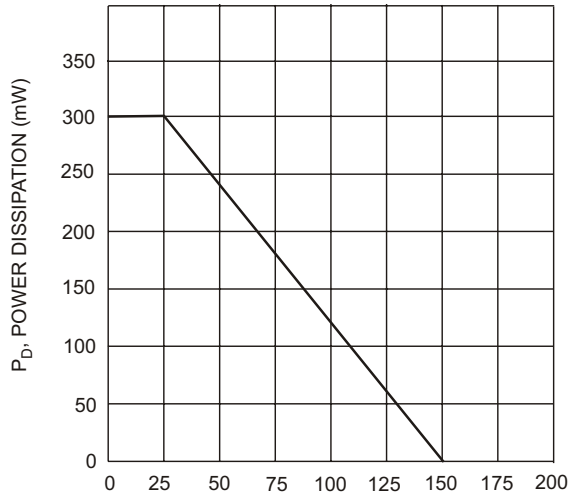

$T_A$ , AMBIENT TEMPERATURE ( $^{\circ}C$ )  
Fig. 1, Max Power Dissipation vs Ambient Temperature (Total Device)

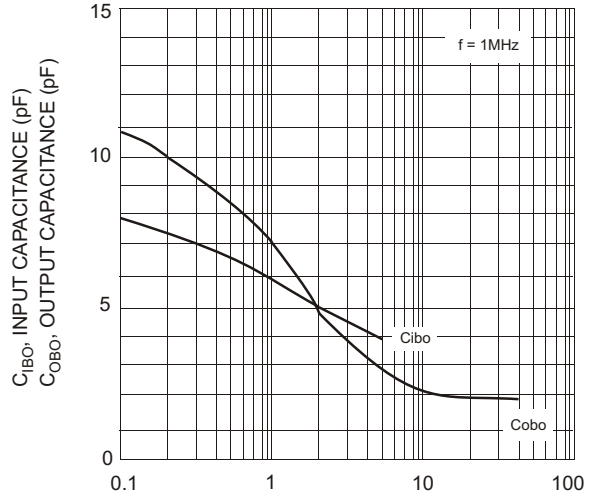

$V_{CB}$ , COLLECTOR-BASE VOLTAGE (V)  
Fig. 2, Input and Output Capacitance vs. Collector-Base Voltage (NPN-3904)

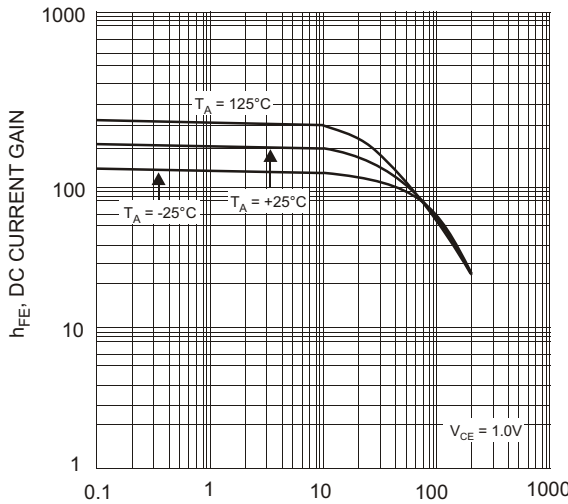

$I_C$ , COLLECTOR CURRENT (mA)  
Fig. 3, Typical DC Current Gain vs Collector Current (NPN-3904)

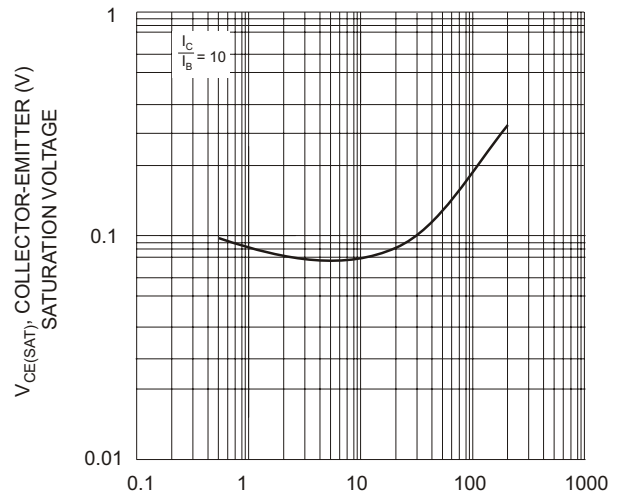

$I_C$ , COLLECTOR CURRENT (mA)  
Fig. 4, Typical Collector-Emitter Saturation Voltage vs. Collector Current (NPN-3904)

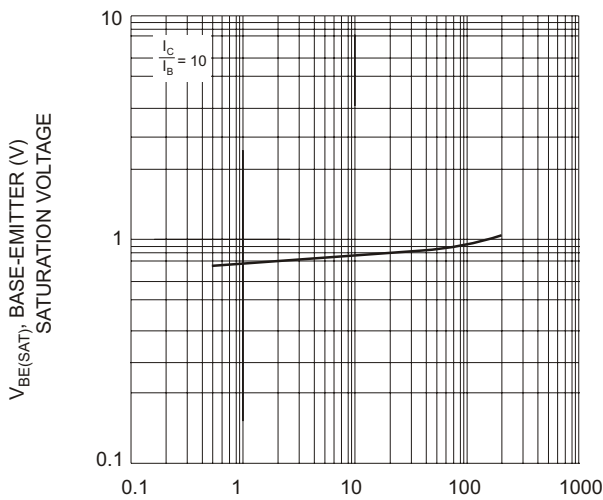

$I_C$ , COLLECTOR CURRENT (mA)  
Fig. 5, Typical Base-Emitter Saturation Voltage vs. Collector Current (NPN-3904)

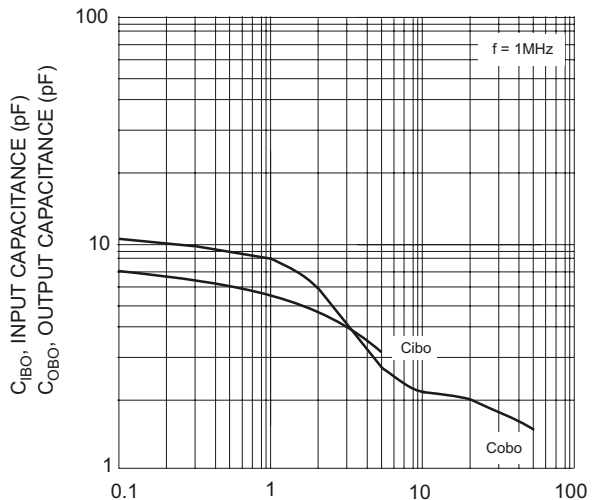

$V_{CB}$ , COLLECTOR-BASE VOLTAGE (V)  
Fig. 6, Input and Output Capacitance vs. Collector-Base Voltage (PNP-3906)

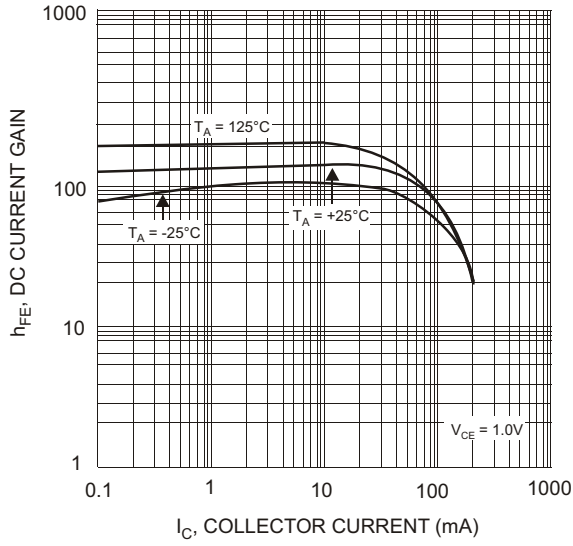

Fig. 7, Typical DC Current Gain vs Collector Current (PNP-3906)

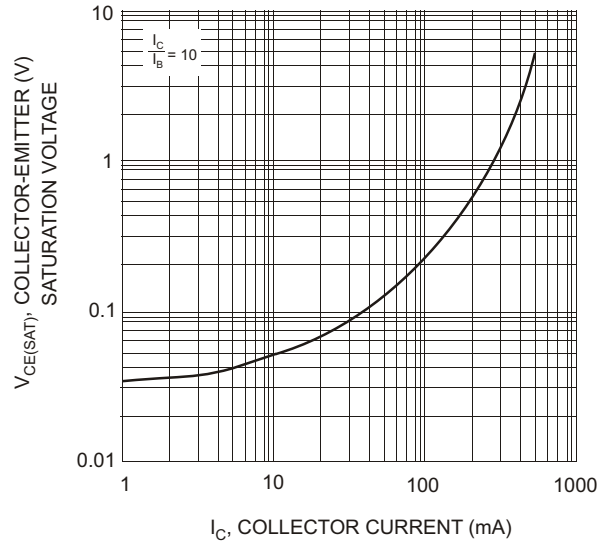

Fig. 8, Typical Collector-Emitter Saturation Voltage vs. Collector Current (PNP-3906)

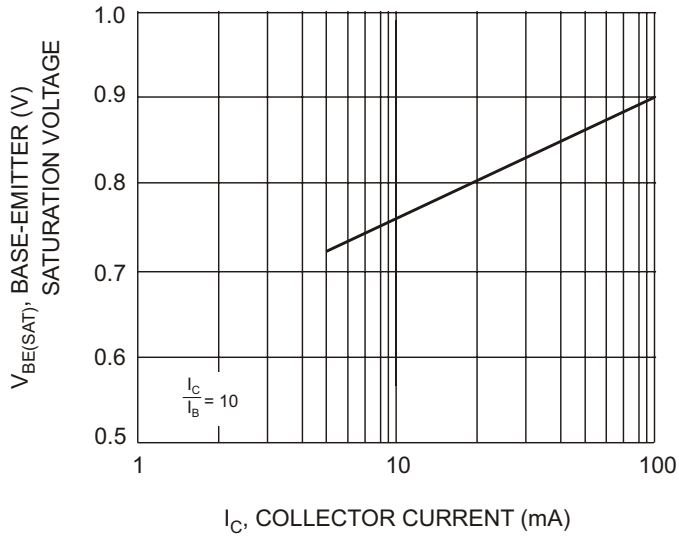

Fig. 9, Typical Base-Emitter Saturation Voltage vs. Collector Current (PNP-3906)