

**MC14069UB**

**Hex Inverter**

The MC14069UB hex inverter is constructed with MOS P-channel and N-channel enhancement mode devices in a single monolithic structure. These inverters find primary use where low power dissipation and/or high noise immunity is desired. Each of the six inverters is a single stage to minimize propagation delays.

- Supply Voltage Range = 3.0 Vdc to 18 Vdc
- Capable of Driving Two Low-Power TTL Loads or One Low-Power Schottky TTL Load Over the Rated Temperature Range
- Triple Diode Protection on All Inputs (see Page 5-2)
- Pin-for-Pin Replacement for CD4069UB
- Meets JEDEC UB Specifications

**MAXIMUM RATINGS\*** (Voltages Referenced to V<sub>SS</sub>)

| Symbol                             | Parameter  | Value                          | Unit |
|------------------------------------|--|--------------------------------|------|
| V <sub>DD</sub>                    | DC Supply Voltage                                  | - 0.5 to + 18.0                | V    |
| V <sub>in</sub> , V <sub>out</sub> | Input or Output Voltage (DC or Transient)          | - 0.5 to V <sub>DD</sub> + 0.5 | V    |
| I <sub>in</sub> , I <sub>out</sub> | Input or Output Current (DC or Transient), per Pin | ± 10                           | mA   |
| P <sub>D</sub>                     | Power Dissipation, per Package†                    | 500                            | mW   |
| T <sub>stg</sub>                   | Storage Temperature                                | - 65 to + 150                  | °C   |
| T <sub>L</sub>                     | Lead Temperature (8-Second Soldering)              | 260                            | °C   |

\* Maximum Ratings are those values beyond which damage to the device may occur.

† Temperature Derating:

Plastic "P and D/DW" Packages: - 7.0 mW/°C From 65°C To 125°C

Ceramic "L" Packages: - 12 mW/°C From 100°C To 125°C

**LOGIC DIAGRAM**

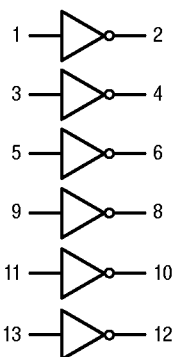

V<sub>DD</sub> = PIN 14  
V<sub>SS</sub> = PIN 7

**CIRCUIT SCHEMATIC**  
(1/6 OF CIRCUIT SHOWN)

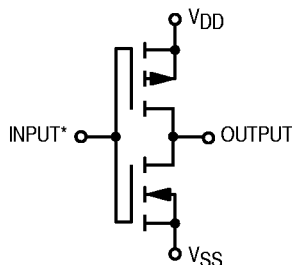

\* Double diode protection on all inputs not shown.

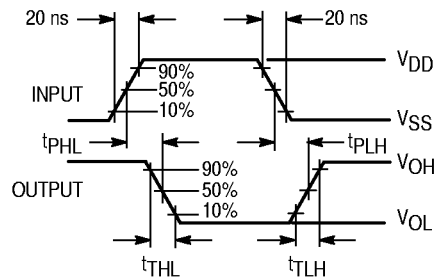
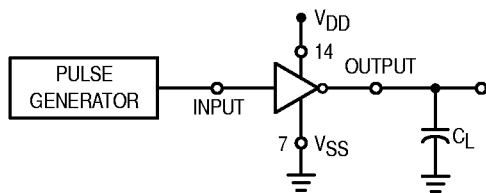
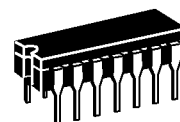
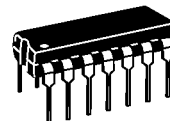

Figure 1. Switching Time Test Circuit and Waveforms



**L SUFFIX**  
CERAMIC  
CASE 632



**P SUFFIX**  
PLASTIC  
CASE 646



**D SUFFIX**  
SOIC  
CASE 751A

**ORDERING INFORMATION**

MC14XXXUBCP Plastic  
MC14XXXUBCL Ceramic  
MC14XXXUBD SOIC  
T<sub>A</sub> = - 55° to 125°C for all packages.

**PIN ASSIGNMENT**

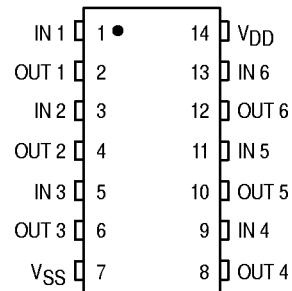

**ELECTRICAL CHARACTERISTICS** (Voltages Referenced to  $V_{SS}$ )

| Characteristic  | Symbol                                     | $V_{DD}$<br>Vdc | -55°C                                      |           | 25°C  |               |           | 125°C |           | Unit      |
|---|--|-----------------|--|-----------|-------|---------------|-----------|-------|-----------|-----------|
|   |  |                 | Min  | Max       | Min   | Typ #         | Max       | Min   | Max       |           |
| Output Voltage<br>$V_{in} = V_{DD}$<br><br>$V_{in} = 0$   | "0" Level<br><br>$V_{OL}$                  | 5.0             | —  | 0.05      | —     | 0             | 0.05      | —     | 0.05      | Vdc       |
|   |  | 10              | —  | 0.05      | —     | 0             | 0.05      | —     | 0.05      |           |
|   |  | 15              | —  | 0.05      | —     | 0             | 0.05      | —     | 0.05      |           |
|   | "1" Level<br><br>$V_{OH}$                  | 5.0             | 4.95                                       | —         | 4.95  | 5.0           | —         | 4.95  | —         | Vdc       |
|   |  | 10              | 9.95                                       | —         | 9.95  | 10            | —         | 9.95  | —         |           |
|   |  | 15              | 14.95                                      | —         | 14.95 | 15            | —         | 14.95 | —         |           |
| Input Voltage<br>( $V_O = 4.5$ Vdc)<br>( $V_O = 9.0$ Vdc)<br>( $V_O = 13.5$ Vdc)<br><br>( $V_O = 0.5$ Vdc)<br>( $V_O = 1.0$ Vdc)<br>( $V_O = 1.5$ Vdc)  | "0" Level<br><br>$V_{IL}$                  | 5.0             | —  | 1.0       | —     | 2.25          | 1.0       | —     | 1.0       | Vdc       |
|   |  | 10              | —  | 2.0       | —     | 4.50          | 2.0       | —     | 2.0       |           |
|   |  | 15              | —  | 2.5       | —     | 6.75          | 2.5       | —     | 2.5       |           |
|   | "1" Level<br><br>$V_{IH}$                  | 5.0             | 4.0  | —         | 4.0   | 2.75          | —         | 4.0   | —         | Vdc       |
|   |  | 10              | 8.0  | —         | 8.0   | 5.50          | —         | 8.0   | —         |           |
|   |  | 15              | 12.5                                       | —         | 12.5  | 8.25          | —         | 12.5  | —         |           |
| Output Drive Current<br>( $V_{OH} = 2.5$ Vdc)<br>( $V_{OH} = 4.6$ Vdc)<br>( $V_{OH} = 9.5$ Vdc)<br>( $V_{OH} = 13.5$ Vdc)<br><br>( $V_{OL} = 0.4$ Vdc)<br>( $V_{OL} = 0.5$ Vdc)<br>( $V_{OL} = 1.5$ Vdc)  | Source<br><br>$I_{OH}$                     | 5.0             | -3.0                                       | —         | -2.4  | -4.2          | —         | -1.7  | —         | mAdc      |
|   |  | 5.0             | -0.64                                      | —         | -0.51 | -0.88         | —         | -0.36 | —         |           |
|   |  | 10              | -1.6                                       | —         | -1.3  | -2.25         | —         | -0.9  | —         |           |
|   | Sink<br><br>$I_{OL}$                       | 5.0             | 0.64                                       | —         | 0.51  | 0.88          | —         | 0.36  | —         | mAdc      |
|   |  | 10              | 1.6  | —         | 1.3   | 2.25          | —         | 0.9   | —         |           |
|   |  | 15              | 4.2  | —         | 3.4   | 8.8           | —         | 2.4   | —         |           |
| Input Current   | $I_{in}$                                   | 15              | —  | $\pm 0.1$ | —     | $\pm 0.00001$ | $\pm 0.1$ | —     | $\pm 1.0$ | $\mu$ Adc |
| Input Capacitance<br>( $V_{in} = 0$ )   | $C_{in}$                                   | —               | —  | —         | —     | 5.0           | 7.5       | —     | —         | pF        |
| Quiescent Current<br>(Per Package)  | $I_{DD}$                                   | 5.0             | —  | 0.25      | —     | 0.0005        | 0.25      | —     | 7.5       | $\mu$ Adc |
|   |  | 10              | —  | 0.5       | —     | 0.0010        | 0.5       | —     | 15        |           |
|   |  | 15              | —  | 1.0       | —     | 0.0015        | 1.0       | —     | 30        |           |
| Total Supply Current**†<br>(Dynamic plus Quiescent,<br>Per Gate) ( $C_L = 50$ pF)   | $I_T$                                      | 5.0             | $I_T = (0.3 \mu\text{A/kHz}) f + I_{DD}/6$ |           |       |               |           |       |           | $\mu$ Adc |
| 10  | $I_T = (0.6 \mu\text{A/kHz}) f + I_{DD}/6$ |                 |  |           |       |               |           |       |           |           |
| 15  | $I_T = (0.9 \mu\text{A/kHz}) f + I_{DD}/6$ |                 |  |           |       |               |           |       |           |           |
| Output Rise and Fall Times**<br>( $C_L = 50$ pF)<br>$t_{TLH}, t_{THL} = (1.35 \text{ ns/pF}) C_L + 33 \text{ ns}$<br>$t_{TLH}, t_{THL} = (0.60 \text{ ns/pF}) C_L + 20 \text{ ns}$<br>$t_{TLH}, t_{THL} = (0.40 \text{ ns/pF}) C_L + 20 \text{ ns}$ | $t_{TLH},$<br>$t_{THL}$                    | 5.0             | —  | —         | —     | 100           | 200       | —     | —         | ns        |
|   |  | 10              | —  | —         | —     | 50            | 100       | —     | —         |           |
|   |  | 15              | —  | —         | —     | 40            | 80        | —     | —         |           |
|   |  | —               | —  | —         | —     | —             | —         | —     | —         |           |
| Propagation Delay Times**<br>( $C_L = 50$ pF)<br>$t_{PLH}, t_{PHL} = (0.90 \text{ ns/pF}) C_L + 20 \text{ ns}$<br>$t_{PLH}, t_{PHL} = (0.36 \text{ ns/pF}) C_L + 22 \text{ ns}$<br>$t_{PLH}, t_{PHL} = (0.26 \text{ ns/pF}) C_L + 17 \text{ ns}$    | $t_{PLH},$<br>$t_{PHL}$                    | 5.0             | —  | —         | —     | 65            | 125       | —     | —         | ns        |
|   |  | 10              | —  | —         | —     | 40            | 75        | —     | —         |           |
|   |  | 15              | —  | —         | —     | 30            | 55        | —     | —         |           |
|   |  | —               | —  | —         | —     | —             | —         | —     | —         |           |

#Data labelled "Typ" is not to be used for design purposes but is intended as an indication of the IC's potential performance.

\*\*The formulas given are for the typical characteristics only at 25°C.

†To calculate total supply current at loads other than 50 pF:

$$I_T(C_L) = I_T(50 \text{ pF}) + (C_L - 50) V f k$$

where:  $I_T$  is in  $\mu\text{A}$  (per package),  $C_L$  in pF,  $V = (V_{DD} - V_{SS})$  in volts,  $f$  in kHz is input frequency, and  $k = 0.002$ .

**This device contains protection circuitry to guard against damage due to high static voltages or electric fields. However, precautions must be taken to avoid applications of any voltage higher than maximum rated voltages to this high-impedance circuit. For proper operation,  $V_{in}$  and  $V_{out}$  should be constrained to the range  $V_{SS} \leq (V_{in} \text{ or } V_{out}) \leq V_{DD}$ . Unused inputs must always be tied to an appropriate logic voltage level (e.g., either  $V_{SS}$  or  $V_{DD}$ ). Unused outputs must be left open.**

## OUTLINE DIMENSIONS

### L SUFFIX CERAMIC DIP PACKAGE CASE 632-08 ISSUE Y

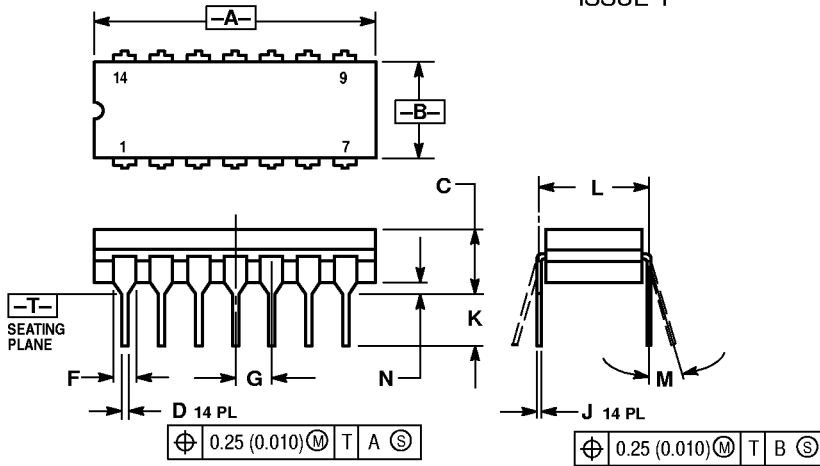

- NOTES:
1. DIMENSIONING AND TOLERANCING PER ANSI Y14.5M, 1982.
  2. CONTROLLING DIMENSION: INCH.
  3. DIMENSION L TO CENTER OF LEAD WHEN FORMED PARALLEL.
  4. DIMENSION F MAY NARROW TO 0.76 (0.030) WHERE THE LEAD ENTERS THE CERAMIC BODY.

| DIM | INCHES    |       | MILLIMETERS |       |
|-----|-----------|-------|-------------|-------|
|     | MIN       | MAX   | MIN         | MAX   |
| A   | 0.750     | 0.785 | 19.05       | 19.94 |
| B   | 0.245     | 0.280 | 6.23        | 7.11  |
| C   | 0.155     | 0.200 | 3.94        | 5.08  |
| D   | 0.015     | 0.020 | 0.39        | 0.50  |
| F   | 0.055     | 0.065 | 1.40        | 1.65  |
| G   | 0.100 BSC |       | 2.54 BSC    |       |
| J   | 0.008     | 0.015 | 0.21        | 0.38  |
| K   | 0.125     | 0.170 | 3.18        | 4.31  |
| L   | 0.300 BSC |       | 7.62 BSC    |       |
| M   | 0° 15°    |       | 0° 15°      |       |
| N   | 0.020     | 0.040 | 0.51        | 1.01  |

### P SUFFIX PLASTIC DIP PACKAGE CASE 646-06 ISSUE L

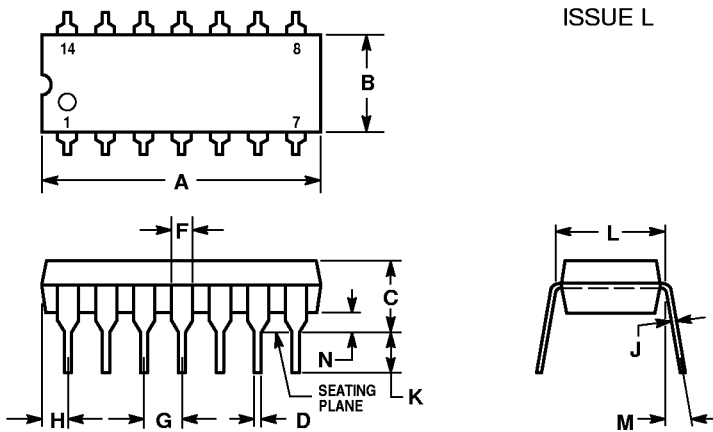

- NOTES:
1. LEADS WITHIN 0.13 (0.005) RADIUS OF TRUE POSITION AT SEATING PLANE AT MAXIMUM MATERIAL CONDITION.
  2. DIMENSION L TO CENTER OF LEADS WHEN FORMED PARALLEL.
  3. DIMENSION B DOES NOT INCLUDE MOLD FLASH.
  4. ROUNDED CORNERS OPTIONAL.

| DIM | INCHES    |       | MILLIMETERS |       |
|-----|-----------|-------|-------------|-------|
|     | MIN       | MAX   | MIN         | MAX   |
| A   | 0.715     | 0.770 | 18.16       | 19.56 |
| B   | 0.240     | 0.260 | 6.10        | 6.60  |
| C   | 0.145     | 0.185 | 3.69        | 4.69  |
| D   | 0.015     | 0.021 | 0.38        | 0.53  |
| F   | 0.040     | 0.070 | 1.02        | 1.78  |
| G   | 0.100 BSC |       | 2.54 BSC    |       |
| H   | 0.052     | 0.095 | 1.32        | 2.41  |
| J   | 0.008     | 0.015 | 0.20        | 0.38  |
| K   | 0.115     | 0.135 | 2.92        | 3.43  |
| L   | 0.300 BSC |       | 7.62 BSC    |       |
| M   | 0° 10°    |       | 0° 10°      |       |
| N   | 0.015     | 0.039 | 0.39        | 1.01  |

## OUTLINE DIMENSIONS

### D SUFFIX PLASTIC SOIC PACKAGE CASE 751A-03 ISSUE F

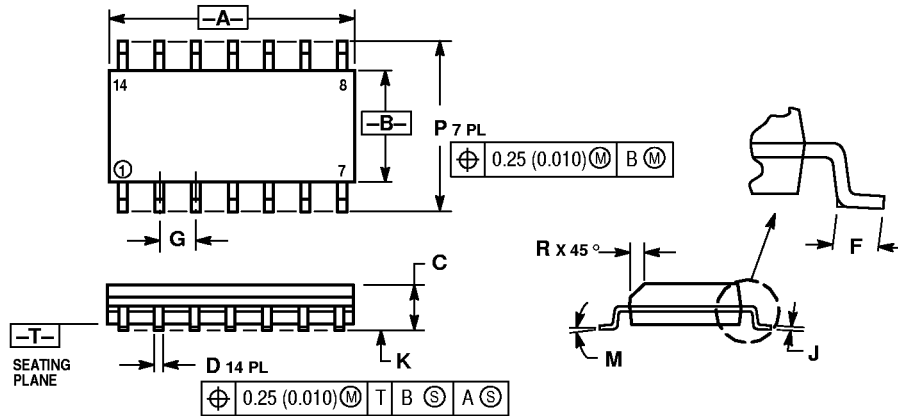

**NOTES:**

1. DIMENSIONING AND TOLERANCING PER ANSI Y14.5M, 1982.
2. CONTROLLING DIMENSION: MILLIMETER.
3. DIMENSIONS A AND B DO NOT INCLUDE MOLD PROTRUSION.
4. MAXIMUM MOLD PROTRUSION 0.15 (0.006) PER SIDE.
5. DIMENSION D DOES NOT INCLUDE DAMBAR PROTRUSION. ALLOWABLE DAMBAR PROTRUSION SHALL BE 0.127 (0.005) TOTAL IN EXCESS OF THE D DIMENSION AT MAXIMUM MATERIAL CONDITION.

| DIM | MILLIMETERS |      | INCHES    |       |
|-----|-------------|------|-----------|-------|
|     | MIN         | MAX  | MIN       | MAX   |
| A   | 8.55        | 8.75 | 0.337     | 0.344 |
| B   | 3.80        | 4.00 | 0.150     | 0.157 |
| C   | 1.35        | 1.75 | 0.054     | 0.068 |
| D   | 0.35        | 0.49 | 0.014     | 0.019 |
| F   | 0.40        | 1.25 | 0.016     | 0.049 |
| G   | 1.27 BSC    |      | 0.050 BSC |       |
| J   | 0.19        | 0.25 | 0.008     | 0.009 |
| K   | 0.10        | 0.25 | 0.004     | 0.009 |
| M   | 0°          | 7°   | 0°        | 7°    |
| P   | 5.80        | 6.20 | 0.228     | 0.244 |
| R   | 0.25        | 0.50 | 0.010     | 0.019 |

Motorola reserves the right to make changes without further notice to any products herein. Motorola makes no warranty, representation or guarantee regarding the suitability of its products for any particular purpose, nor does Motorola assume any liability arising out of the application or use of any product or circuit, and specifically disclaims any and all liability, including without limitation consequential or incidental damages. "Typical" parameters which may be provided in Motorola data sheets and/or specifications can and do vary in different applications and actual performance may vary over time. All operating parameters, including "Typicals" must be validated for each customer application by customer's technical experts. Motorola does not convey any license under its patent rights nor the rights of others. Motorola products are not designed, intended, or authorized for use as components in systems intended for surgical implant into the body, or other applications intended to support or sustain life, or for any other application in which the failure of the Motorola product could create a situation where personal injury or death may occur. Should Buyer purchase or use Motorola products for any such unintended or unauthorized application, Buyer shall indemnify and hold Motorola and its officers, employees, subsidiaries, affiliates, and distributors harmless against all claims, costs, damages, and expenses, and reasonable attorney fees arising out of, directly or indirectly, any claim of personal injury or death associated with such unintended or unauthorized use, even if such claim alleges that Motorola was negligent regarding the design or manufacture of the part. Motorola and  are registered trademarks of Motorola, Inc. Motorola, Inc. is an Equal Opportunity/Affirmative Action Employer.

**How to reach us:**

**USA/EUROPE/Locations Not Listed:** Motorola Literature Distribution;  
P.O. Box 20912; Phoenix, Arizona 85036. 1-800-441-2447 or 602-303-5454

**MFAX:** RMFAX0@email.sps.mot.com – TOUCHTONE 602-244-6609  
**INTERNET:** <http://Design-NET.com>

**JAPAN:** Nippon Motorola Ltd.; Tatsumi-SPD-JLDC, 6F Seibu-Butsuryu-Center,  
3-14-2 Tatsumi Koto-Ku, Tokyo 135, Japan. 03-81-3521-8315

**ASIA/PACIFIC:** Motorola Semiconductors H.K. Ltd.; 8B Tai Ping Industrial Park,  
51 Ting Kok Road, Tai Po, N.T., Hong Kong. 852-26629298



MC14069UB/D

