



# Photocoupler

## Product Data Sheet

### LTV-356T

Spec No.: DS70-2001-010

Effective Date: 06/03/2015

Revision: L

**LITE-ON DCC**

**RELEASE**

**BNS-OD-FC001/A4**

## Photocouplers LTV-356T

### 1. DESCRIPTION

#### 1.1 Features

- Current transfer ratio ( CTR : MIN. 50% at  $I_F = 5\text{mA}$ ,  $V_{CE} = 5\text{V}$  )
- High input-output isolation voltage (  $V_{iso} = 3,750\text{Vrms}$  )
- High collector-emitter voltage (  $V_{CEO} = 80\text{V}$  )
- Subminiature type (The volume is smaller than that of conventional DIP type by as far as 30%)
- Employs double transfer mold technology
- Mini-flat package : 2.0mm profile : LTV-356T
- Safety approval
  - UL 1577
  - VDE DIN EN60747-5-5 (VDE 0884-5) ,
  - CSA CA5A
  - CQC GB4943.1-2011/ GB8898-2011
  - FIMKO/DEMKO/SEMKO/NEMKO
- RoHS Compliance
  - All materials be used in device are followed EU RoHS directive (No.2002/95/EC).
- ESD pass HBM 8000V/ MM2000V/ CDM2000V
- MSL class1

#### 1.2 Applications

- Hybrid substrates that require high density mounting.
- Programmable controllers

# Photocouplers LTV-356T

## 2. PACKAGE DIMENSIONS

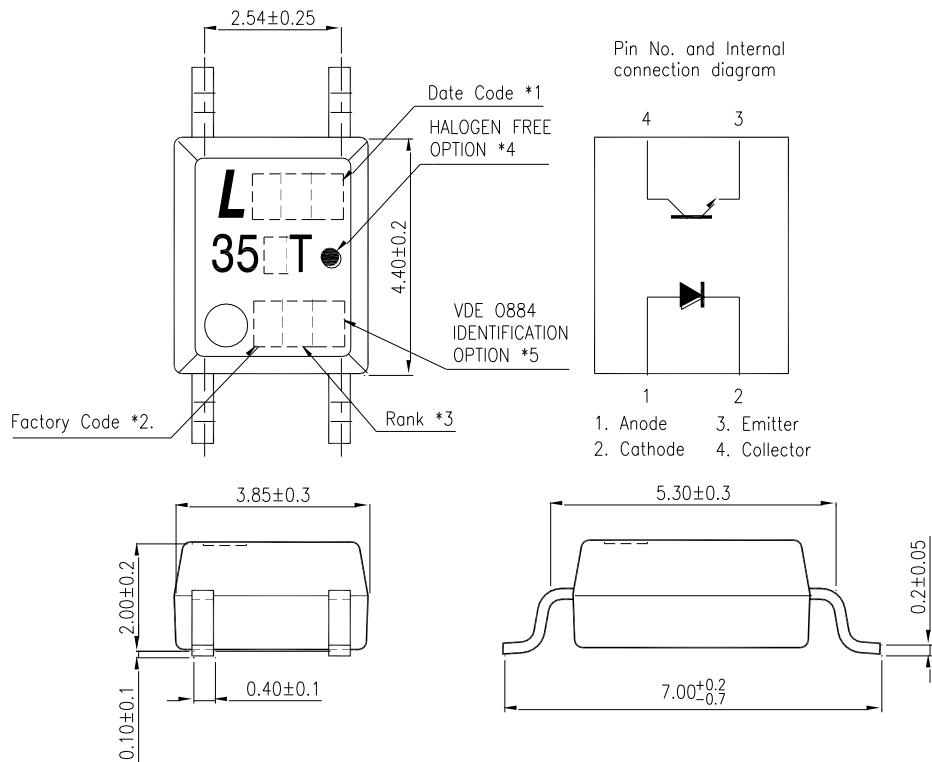

Part No : LTV-356T

### Notes :

1. 1-digit Year date code, 2-digit work week.
2. Factory identification mark shall be marked (W: China -CZ, X: China -TJ)
3. Rank shall be or shall not be marked.
4. "●" indicates halogen free option.
5. "4" or "V" for VDE option.

**Photocouplers  
LTV-356T**

**3. TAPING DIMENSIONS**

P/N : LTV-356T

**TP1 MINI FLAT (3000pcs/reel): No Suffix & Suffix "TP1"**

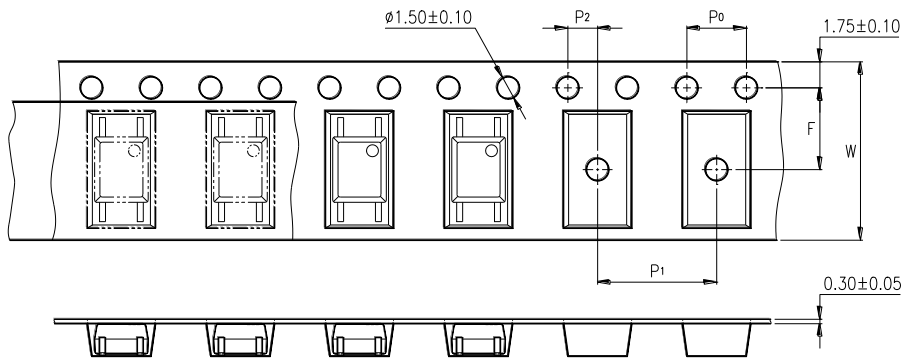

**TP MINI FLAT (3000pcs/reel) : Suffix "-TP"**

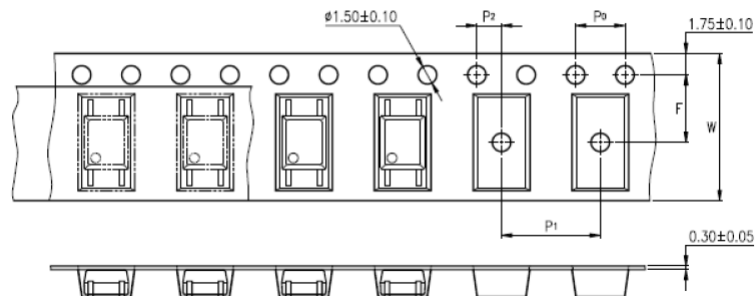

Description	Symbol	Dimension in mm (inch)
Tape wide	W	12±0.3 (0.47)
Pitch of sprocket holes	P <sub>0</sub>	4±0.1 (0.15)
Distance of compartment	F	5.5±0.1 (0.217)
	P <sub>2</sub>	2±0.1 (0.079)
Distance of compartment to compartment	P <sub>1</sub>	8±0.1 (0.315)

**Photocouplers  
LTV-356T**

**4. RATING AND CHARACTERISTICS**

**4.1 Absolute Maximum Ratings at Ta=25°C**

	Parameter	Symbol	Rating	Unit
Input	Forward Current	$I_F$	50	mA
	Reverse Voltage	$V_R$	6	V
	Power Dissipation	$P$	70	mW
Output	Collector - Emitter Voltage	$V_{CEO}$	80	V
	Emitter - Collector Voltage	$V_{ECO}$	6	V
	Collector Current	$I_C$	50	mA
	Collector Power Dissipation	$P_C$	150	mW
	Total Power Dissipation	$P_{tot}$	170	mW
1.	Isolation Voltage	$V_{iso}$	3750	$V_{rms}$
	Operating Temperature	$T_{opr}$	-55 ~ +110	°C
	Storage Temperature	$T_{stg}$	-55 ~ +150	°C
2.	Soldering Temperature	$T_{sol}$	260	°C

1. AC For 1 Minute, R.H. = 40 ~ 60%

Isolation voltage shall be measured using the following method.

- (1) Short between anode and cathode on the primary side and between collector and emitter on the secondary side.
- (2) The isolation voltage tester with zero-cross circuit shall be used.
- (3) The waveform of applied voltage shall be a sine wave.

2. For 10 Seconds

## Photocouplers LTV-356T

### 4.2 ELECTRICAL OPTICAL CHARACTERISTICS at Ta=25°C

Parameter		Symbol	Min.	Typ.	Max.	Unit	Test Condition
Input	Forward Voltage	$V_F$	—	1.2	1.4	V	$I_F=20\text{mA}$
	Reverse Current	$I_R$	—	—	10	$\mu\text{A}$	$V_R=4\text{V}$
	Terminal Capacitance	$C_t$	—	30	250	pF	$V=0, f=1\text{KHz}$
Output	Collector Dark Current	$I_{CEO}$	—	—	100	nA	$V_{CE}=20\text{V}, I_F=0$
	Collector-Emitter Breakdown Voltage	$BV_{CEO}$	80	—	—	V	$I_C=0.1\text{mA}, I_F=0$
	Emitter-Collector Breakdown Voltage	$BV_{ECO}$	6	—	—	V	$I_E=10\mu\text{A}, I_F=0$
TRANSFER CHARACTERISTICS	Collector Current	$I_C$	2.5	—	30	mA	$I_F=5\text{mA}$
	1. Current Transfer Ratio	CTR	50	—	600	%	$V_{CE}=5\text{V}$
	Collector-Emitter Saturation Voltage	$V_{CE(sat)}$	—	—	0.2	V	$I_F=20\text{mA}$ $I_C=1\text{mA}$
	Isolation Resistance	$R_{iso}$	$5 \times 10^{10}$	$1 \times 10^{11}$	—	$\Omega$	DC500V, 40 ~ 60% R.H.
	Floating Capacitance	$C_f$	—	0.6	1	pF	$V=0, f=1\text{MHz}$
	Response Time (Rise)	$t_r$	—	4	18	$\mu\text{s}$	$V_{CE}=2\text{V},$ $I_C=2\text{mA}$
	Response Time (Fall)	$t_f$	—	3	18	$\mu\text{s}$	$R_L=100\Omega,$

$$1. \text{CTR} = \frac{I_C}{I_F} \times 100\%$$

**Photocouplers  
LTV-356T**

**5. RANK TABLE OF CURRENT TRANSFER RATIO CTR**

Parameter	CTR Rank	Min	Max	Condition
DC Current Transfer Ratio	A	80	160	$I_F=5\text{mA}$ , $V_{CE}=5\text{V}$ , $T_a=25^\circ\text{C}$
	B	130	260	
	C	200	400	
	D	300	600	
	A or B or C or D or No mark	50	600	

# Photocouplers LTV-356T

## 6. CHARACTERISTICS CURVES

Fig.1 Forward Current vs. Ambient Temperature

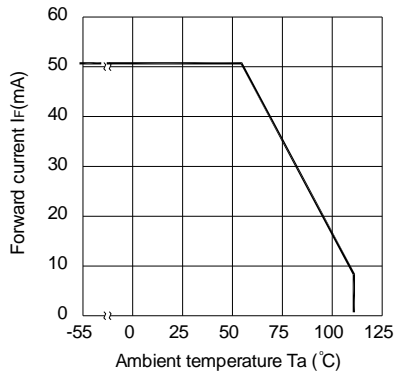

Fig.2 Collector Power Dissipation vs. Ambient Temperature

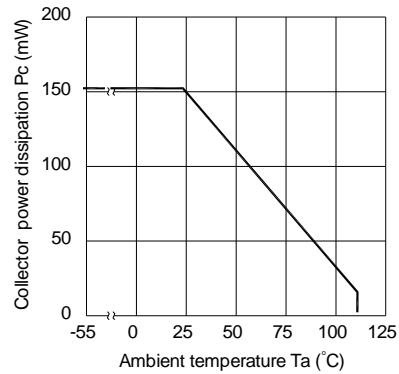

Fig.3 Collector-emitter Saturation Voltage vs. Forward Current

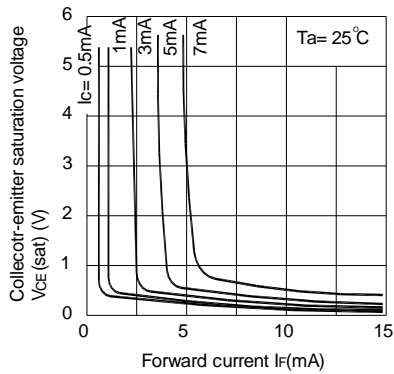

Fig.4 Forward Current vs. Forward Voltage

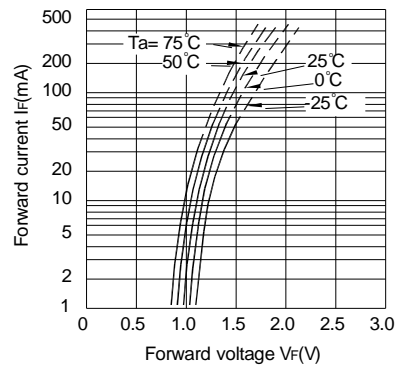

Fig.5 Current Transfer Ratio vs. Forward Current

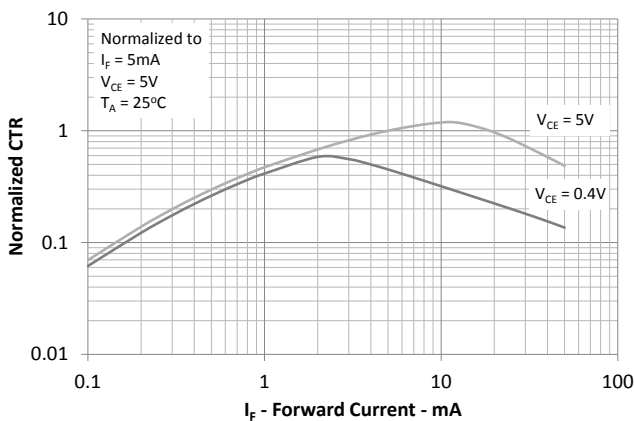
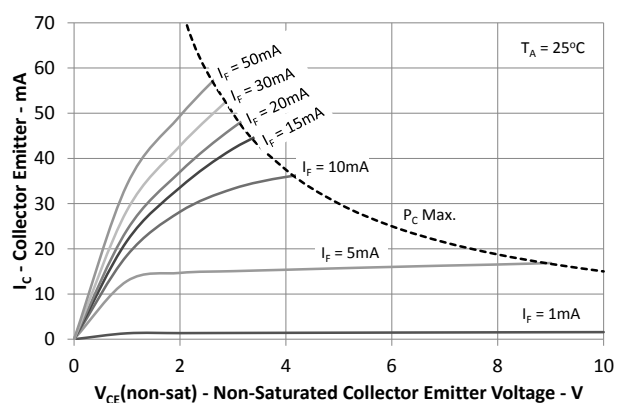

Fig.6 Collector Current vs. Collector-emitter Voltage





## Photocouplers LTV-356T

Fig.7 Relative Current Transfer Ratio vs. Ambient Temperature

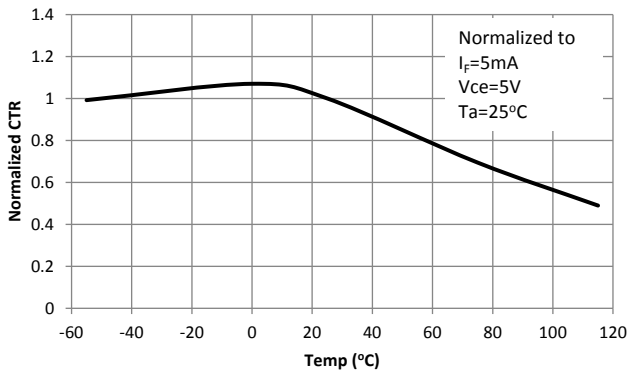

Fig.8 Collector-emitter Saturation Voltage vs. Ambient Temperature

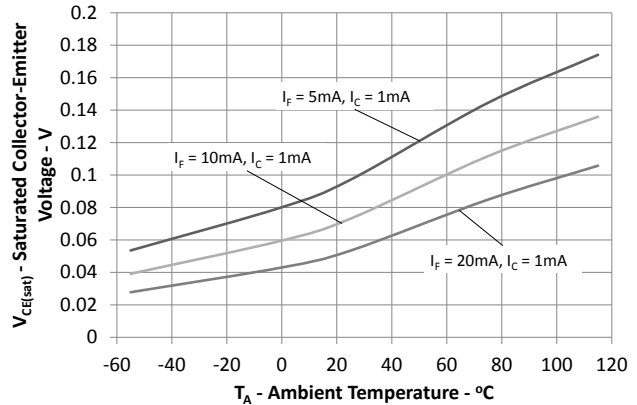

Fig.9 Collector Dark Current vs. Ambient Temperature

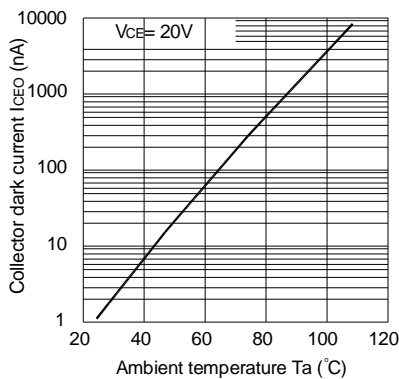

Fig.10 Response Time vs. Load Resistance

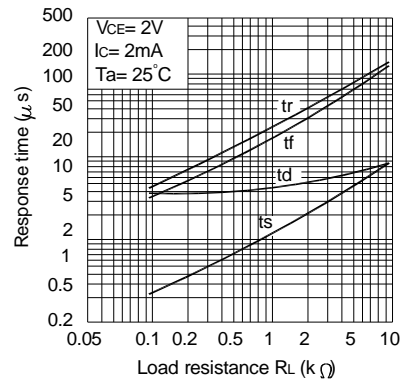
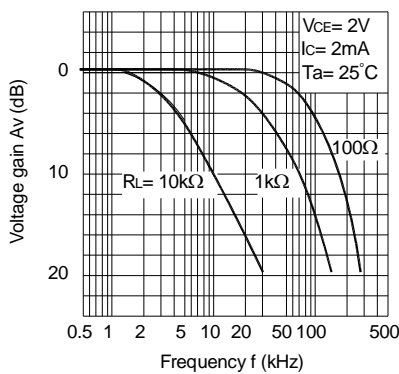
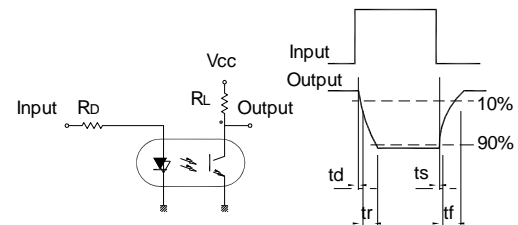

Fig.11 Frequency Response



Test Circuit for Response Time



Test Circuit for Frequency Response

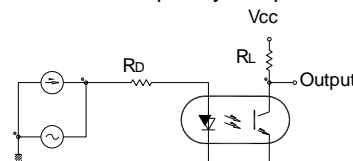

# Photocouplers LTV-356T

## 7. TEMPERATURE PROFILE OF SOLDERING

### 7.1 IR Reflow soldering (JEDEC-STD-020C compliant)

One time soldering reflow is recommended within the condition of temperature and time profile shown below. Do not solder more than three times.

Profile item	Conditions
Preheat	
- Temperature Min ( $T_{Smin}$ )	150°C
- Temperature Max ( $T_{Smax}$ )	200°C
- Time (min to max) (ts)	90±30 sec
Soldering zone	
- Temperature ( $T_L$ )	217°C
- Time ( $t_L$ )	60 ~ 100 sec
Peak Temperature ( $T_P$ )	260°C
Ramp-up rate	3°C / sec max.
Ramp-down rate	3~6°C / sec

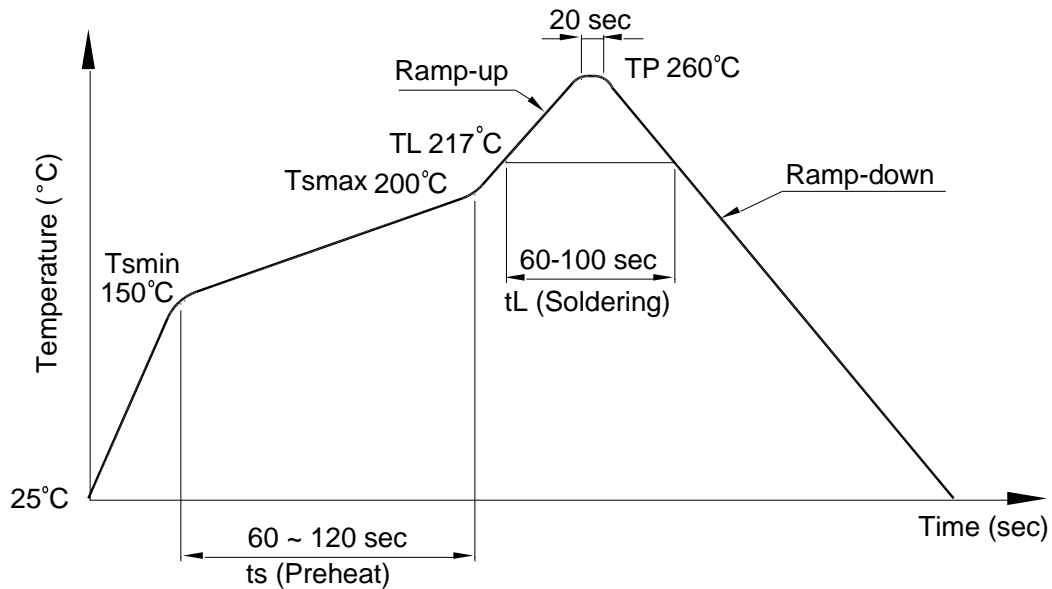

**Photocouplers  
LTV-356T**

**7.2 Wave soldering (JEDEC22A111 compliant)**

One time soldering is recommended within the condition of temperature.

Temperature:  $260 \pm 0 / -5^{\circ}\text{C}$

Time: 10 sec.

Preheat temperature: 25 to  $140^{\circ}\text{C}$

Preheat time: 30 to 80 sec.

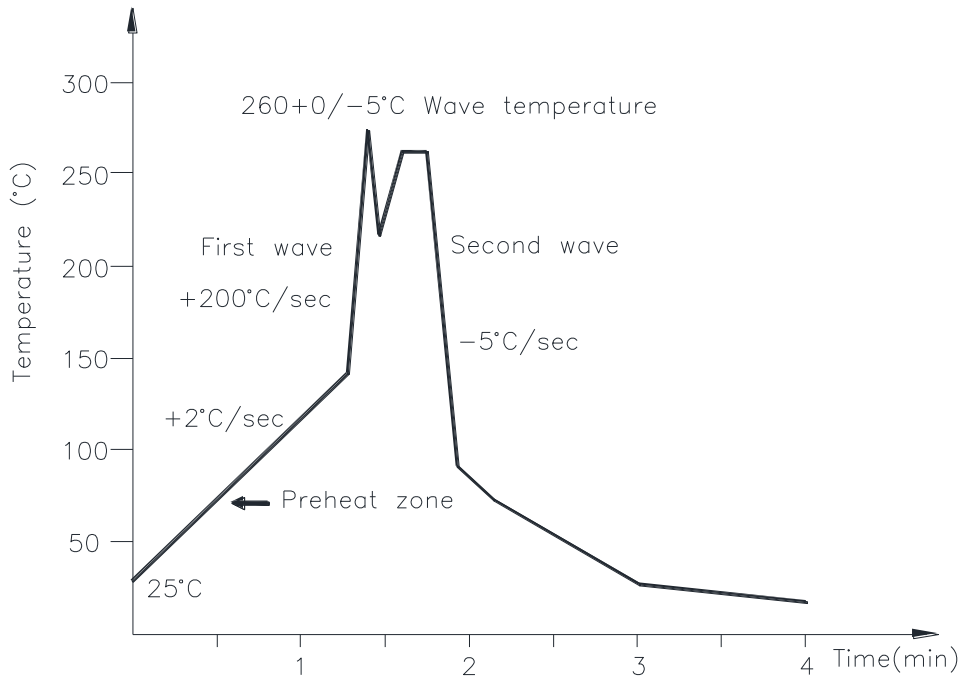

**7.3 Hand soldering by soldering iron**

Allow single lead soldering in every single process. One time soldering is recommended.

Temperature:  $380 \pm 0 / -5^{\circ}\text{C}$

Time: 3 sec max.

## 8. RRECOMMENDED FOOT PRINT PATTERNS (MOUNT PAD)

Unit: mm

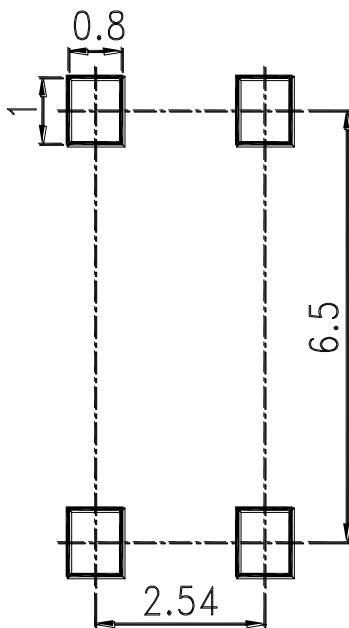

## 9. Notes:

- LiteOn is continually improving the quality, reliability, function or design and LiteOn reserves the right to make changes without further notices.
- The products shown in this publication are designed for the general use in electronic applications such as office automation equipment, communications devices, audio/visual equipment, electrical application and instrumentation.
- For equipment/devices where high reliability or safety is required, such as space applications, nuclear power control equipment, medical equipment, etc, please contact our sales representatives.
- When requiring a device for any "specific" application, please contact our sales in advice.
- If there are any questions about the contents of this publication, please contact us at your convenience.
- The contents described herein are subject to change without prior notice.
- Immerse unit's body in solder paste is not recommended.