

4-Line BUS-Port ESD-Protection

Features

- Ultra compact LLP75-6A package
- 4-line USB ESD-protection
- Low leakage current
- Low load capacitance $C_D = 1.2$ pF
- ESD-protection acc. IEC 61000-4-2
 ± 30 kV contact discharge
 ± 30 kV air discharge
- High surge current acc. IEC61000-4-5 $I_{PP} > 11$ A
- Lead (Pb)-free component
- Component in accordance to RoHS 2002/95/EC and WEEE 2002/96/EC



RoHS
COMPLIANT
GREEN
[5-2008]*

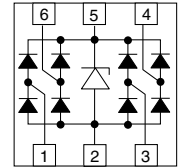
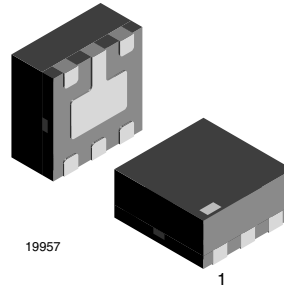

19957

20397

Marking (example only)

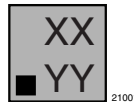

Dot = Pin 1 marking
 XX = Date code
 YY = Type code (see table below)

Ordering Information

Device name	Ordering code	Taped units per reel (8 mm tape on 7" reel)	Minimum order quantity
VBUS054CV-HS3	VBUS054CV-HS3-GS08	3000	15000

Package Data

Device name	Package name	Marking code	Weight	Molding compound flammability rating	Moisture sensitivity level	Soldering conditions
VBUS054CV-HS3	LLP75-6A	U8	5.1 mg	UL 94 V-0	MSL level 1 (according J-STD-020)	260 °C/10 s at terminals

Absolute Maximum Ratings

Parameter	Test conditions	Symbol	Value	Unit
Peak pulse current	Pin 1, 3, 4 or 6 to pin 2 acc. IEC 61000-4-5; $t_p = 8/20$ μ s; single shot	I_{PPM}	11	A
	Pin 5 to pin 2 acc. IEC 61000-4-5; $t_p = 8/20$ μ s; single shot	I_{PPM}	13	A
Peak pulse power	Pin 1, 3, 4 or 6 to pin 2 acc. IEC 61000-4-5; $t_p = 8/20$ μ s; single shot	P_{PP}	242	W
	Pin 5 to pin 2 acc. IEC 61000-4-5; $t_p = 8/20$ μ s; single shot	P_{PP}	246	W
ESD immunity	Contact discharge acc. IEC 61000-4-2; 10 pulses	V_{ESD}	± 30	kV
	Air discharge acc. IEC 61000-4-2; 10 pulses	V_{ESD}	± 30	kV
Operating temperature	Junction temperature	T_J	- 40 to + 125	°C
Storage temperature		T_{STG}	- 40 to + 150	°C

* Please see document "Vishay Green and Halogen-Free Definitions (5-2008)" <http://www.vishay.com/doc?99902>

Electrical Characteristics

Ratings at 25 °C, ambient temperature unless otherwise specified

VBUS054CV-HS3

Date line: pin 1 , 3, 4 or 6 to pin 2

Parameter	Test conditions/remarks	Symbol	Min.	Typ.	Max.	Unit
Protection paths	Number of line which can be protected	N_{lines}			4	lines
Reverse working voltage	at $I_R = 0.1 \mu A$	V_{RWM}	5			V
Reverse current	at $V_{IN} = V_{RWM} = 5 V$	I_R		< 0.01	0.1	μA
Reverse breakdown voltage	at $I_R = 1 mA$	V_{BR}	7	7.9	8.6	V
Reverse clamping voltage	at $I_{PP} = 11 A$; acc. IEC 61000-4-5	V_C		18	22	V
Forward clamping voltage	at $I_F = 11 A$; acc. IEC 61000-4-5	V_F		6.5	8	V
Data line capacitance	V_R (at I/O pin) = 0 V; V_R (at pin 5) = 5 V; f = 1 MHz	C_D		1.2	2.5	pF
Line Symmetry	Difference of the line capacitances	dC_D			0.2	pF

VBUS054CV-HS3

V_{BUS} -line: pin 5 to pin 2

Parameter	Test conditions/remarks	Symbol	Min.	Typ.	Max.	Unit
Reverse working voltage	at $I_R = 0.1 \mu A$	V_{RWM}	5	6.6		V
Reverse current	at $V_{IN} = V_{RWM} = 5 V$	I_R		< 0.01	0.1	μA
Reverse breakdown voltage	at $I_R = 1 mA$	V_{BR}	7	7.9	8.6	V
Reverse clamping voltage	at $I_{PP} = 13 A$; acc. IEC 61000-4-5	V_C		18	22	V
Forward clamping voltage	at $I_F = 13 A$; acc. IEC 61000-4-5	V_F			7	V
Line capacitance	V_R (at pin 5) = 0 V; f = 1 MHz	C_D		190		pF

Application Note

With the VBUS054CV-HS3 a double, high speed USB-port can be protected against transient voltage signals. Negative transients will be clamped close below the ground level while positive transients will be clamped close above the 5 V working range. An avalanche diode clamps the supply line (V_{BUS} at pin 5) to ground (pin 2). The high speed data lines, D1+, D2+, D1- and D2-, are connected to pin 1, 3, 4 and 6. As long as the signal voltage on the data lines is between the ground- and the V_{BUS} -level, the low capacitance PN-diodes offer a very high isolation to V_{BUS} , ground and to the other data lines. But as soon as any transient signal exceeds this working range, one of the PN-diodes gets in the forward mode and clamps the transient to ground or the avalanche break through voltage level.

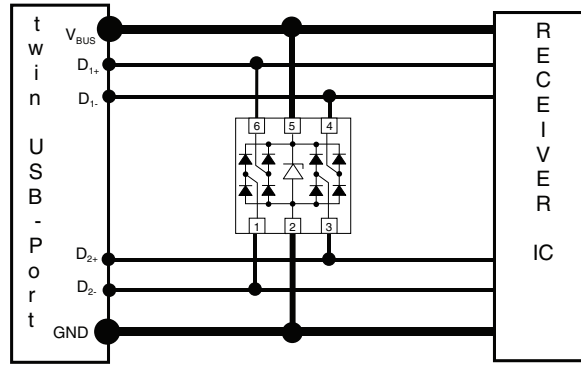

Typical Characteristics

$T_{amb} = 25\text{ }^{\circ}\text{C}$, unless otherwise specified

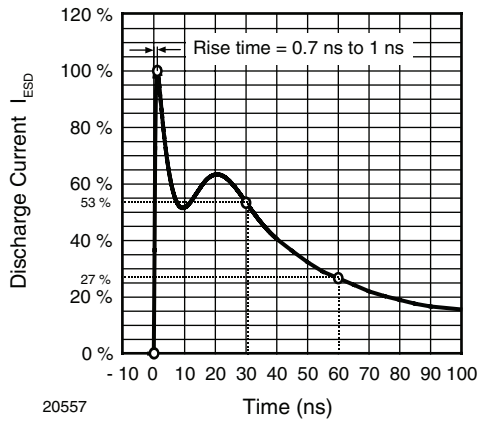

20557

Figure 1. ESD Discharge Current Wave Form acc. IEC 61000-4-2 (330 Ω /150 pF)

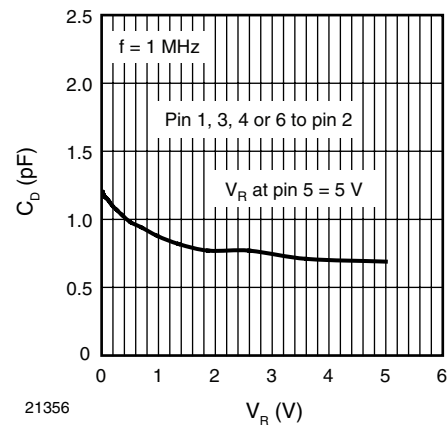

21356

Figure 3. Typical Capacitance C_D vs. Reverse Voltage V_R

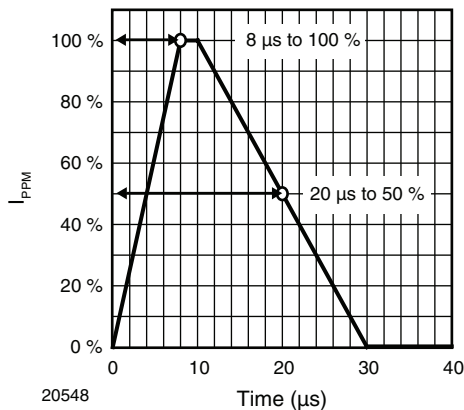

20548

Figure 2. 8/20 μs Peak Pulse Current Wave Form acc. IEC 61000-4-5

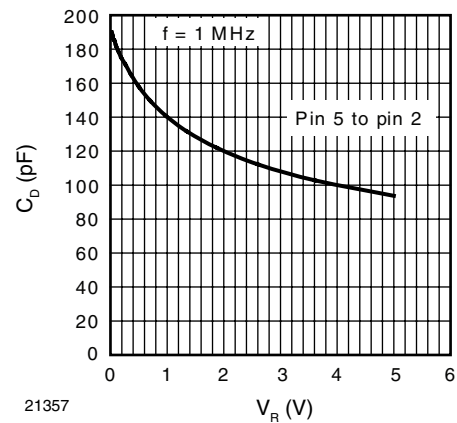

21357

Figure 4. Typical Capacitance C_D vs. Reverse Voltage V_R

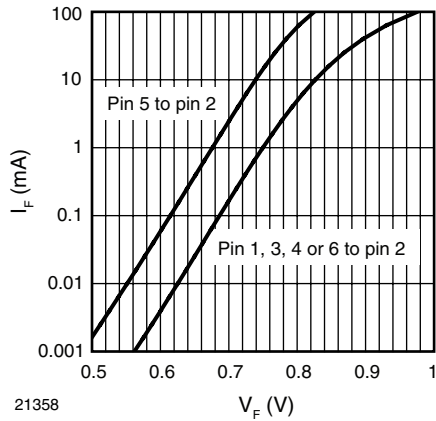

Figure 5. Typical Forward Current I_F vs. Forward Voltage V_F

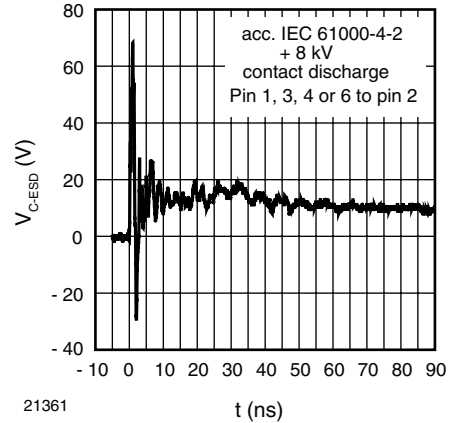

Figure 8. Typical Clamping Performance at +8 kV Contact Discharge (acc. IEC 61000-4-2)

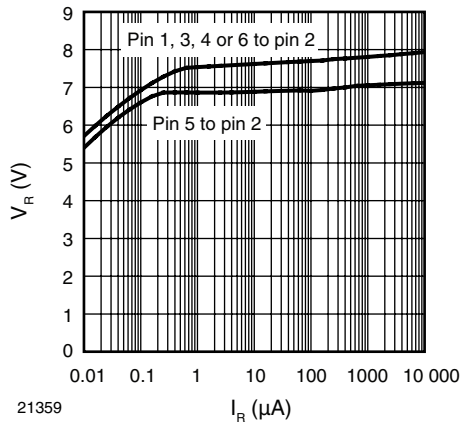

Figure 6. Typical Reverse Voltage V_R vs. Reverse Current I_R

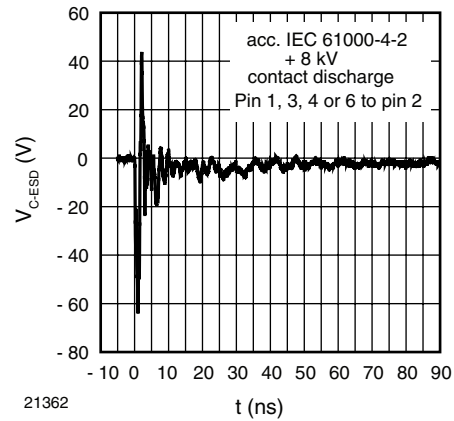

Figure 9. Typical Clamping performance at -8 kV Contact Discharge (acc. IEC 61000-4-2)

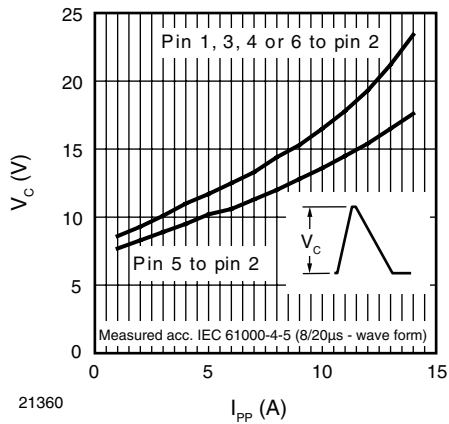

Figure 7. Typical Peak Clamping Voltage V_C vs. Peak Pulse Current I_{PP}

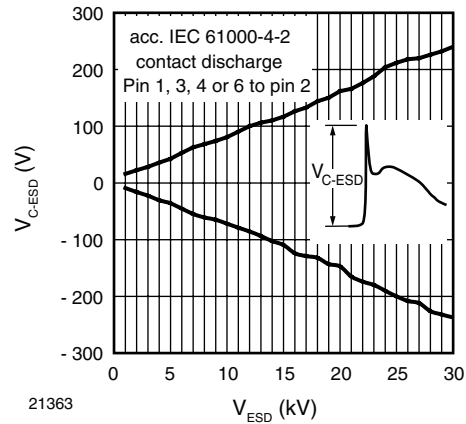
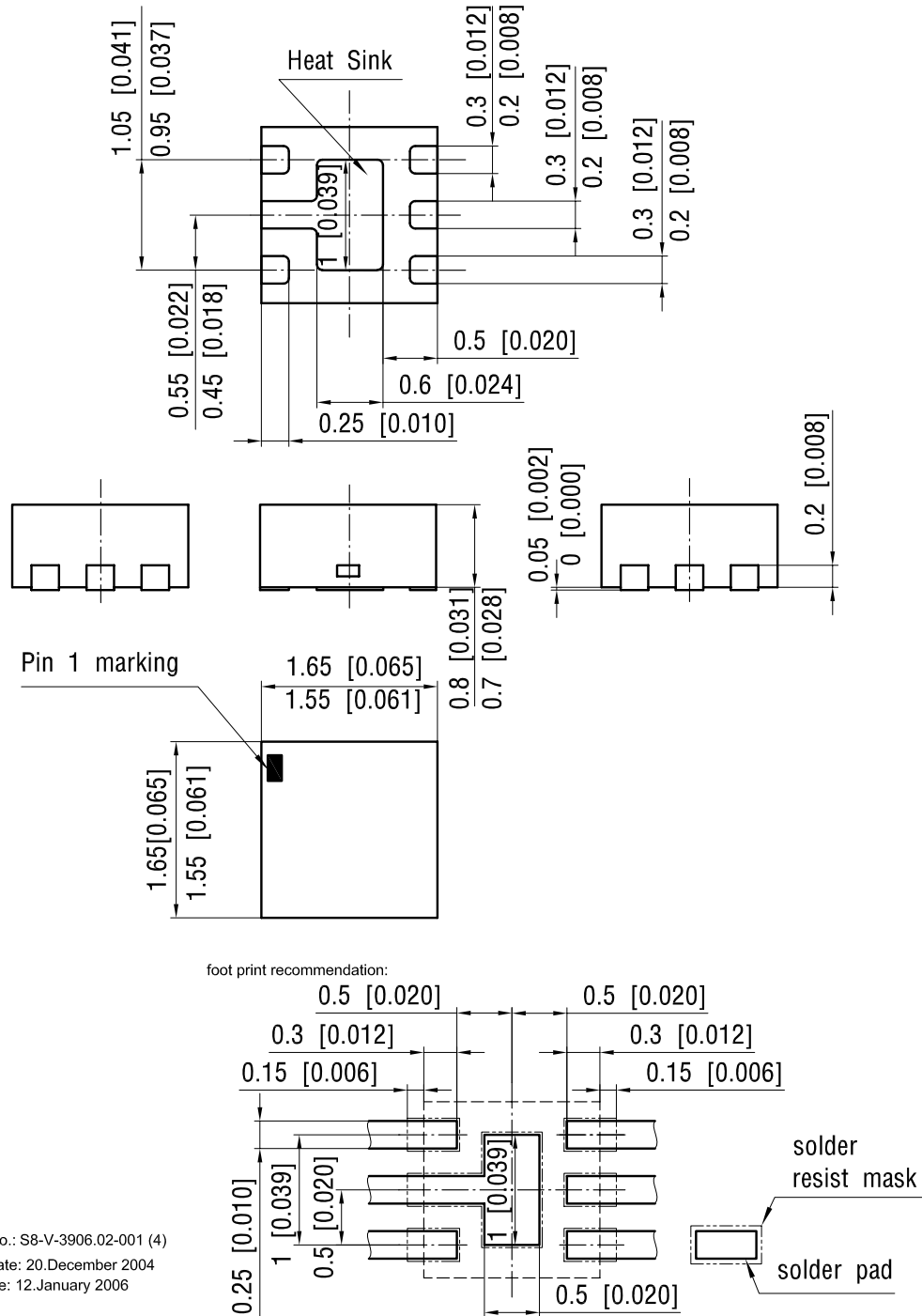

Figure 10. Typical Peak Clamping Voltage at ESD Contact Discharge (acc. IEC 61000-4-2)

Package Dimensions in millimeters (inches): LLP75-6A



Document no.: S8-V-3906.02-001 (4)
Created - Date: 20.December 2004
Rev. b - Date: 12.January 2006
18058

Ozone Depleting Substances Policy Statement

It is the policy of Vishay Semiconductor GmbH to

1. Meet all present and future national and international statutory requirements.
2. Regularly and continuously improve the performance of our products, processes, distribution and operating systems with respect to their impact on the health and safety of our employees and the public, as well as their impact on the environment.

It is particular concern to control or eliminate releases of those substances into the atmosphere which are known as ozone depleting substances (ODSs).

The Montreal Protocol (1987) and its London Amendments (1990) intend to severely restrict the use of ODSs and forbid their use within the next ten years. Various national and international initiatives are pressing for an earlier ban on these substances.

Vishay Semiconductor GmbH has been able to use its policy of continuous improvements to eliminate the use of ODSs listed in the following documents.

1. Annex A, B and list of transitional substances of the Montreal Protocol and the London Amendments respectively.
2. Class I and II ozone depleting substances in the Clean Air Act Amendments of 1990 by the Environmental Protection Agency (EPA) in the USA.
3. Council Decision 88/540/EEC and 91/690/EEC Annex A, B and C (transitional substances) respectively.

Vishay Semiconductor GmbH can certify that our semiconductors are not manufactured with ozone depleting substances and do not contain such substances.

We reserve the right to make changes to improve technical design
and may do so without further notice.

Parameters can vary in different applications. All operating parameters must be validated for each customer application by the customer. Should the buyer use Vishay Semiconductors products for any unintended or unauthorized application, the buyer shall indemnify Vishay Semiconductors against all claims, costs, damages, and expenses, arising out of, directly or indirectly, any claim of personal damage, injury or death associated with such unintended or unauthorized use.

Vishay Semiconductor GmbH, P.O.B. 3535, D-74025 Heilbronn, Germany



Disclaimer

All product specifications and data are subject to change without notice.

Vishay Intertechnology, Inc., its affiliates, agents, and employees, and all persons acting on its or their behalf (collectively, "Vishay"), disclaim any and all liability for any errors, inaccuracies or incompleteness contained herein or in any other disclosure relating to any product.

Vishay disclaims any and all liability arising out of the use or application of any product described herein or of any information provided herein to the maximum extent permitted by law. The product specifications do not expand or otherwise modify Vishay's terms and conditions of purchase, including but not limited to the warranty expressed therein, which apply to these products.

No license, express or implied, by estoppel or otherwise, to any intellectual property rights is granted by this document or by any conduct of Vishay.

The products shown herein are not designed for use in medical, life-saving, or life-sustaining applications unless otherwise expressly indicated. Customers using or selling Vishay products not expressly indicated for use in such applications do so entirely at their own risk and agree to fully indemnify Vishay for any damages arising or resulting from such use or sale. Please contact authorized Vishay personnel to obtain written terms and conditions regarding products designed for such applications.

Product names and markings noted herein may be trademarks of their respective owners.