

SINGLE OPERATIONAL AMPLIFIERS

- INPUT OFFSET VOLTAGE :
4 mV max. LM118 – LM218
10 mV max. LM318
- INPUT BIAS CURRENT :
250nA max.
- INPUT OFFSET CURRENT :
50nA max.
- SLEW RATE OF 150 V/μs AS INVERTING AMPLIFIER

DESCRIPTION

The LM118, LM218 and LM318 are precision high speed operational amplifiers designed for applications requiring wide bandwidth and high slew rate. They feature internal frequency compensation and a factor of ten increase in speed over general purpose devices.

Although, no external frequency compensation components are needed for operation, feedforward compensation may be used to further increase the speed. For inverting applications, feedforward compensation will boost the slew rate to over 150 V/μs and almost double the bandwidth. However, for non-inverting or differential applications feedforward cannot be used.

The high speed and fast settling time of these op amps make them useful in A/D converters, oscillators, active filters, sample and hold circuits, or general purpose amplifiers.

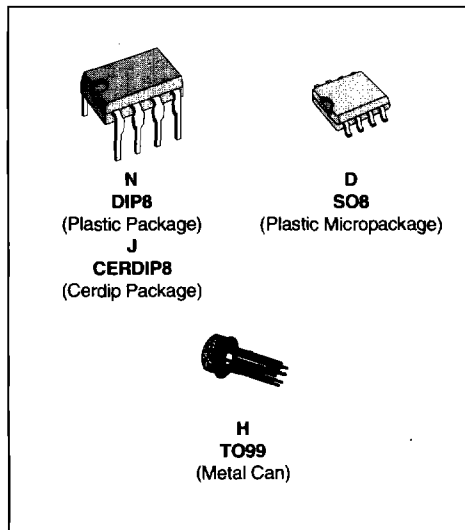

ORDER CODES

Part Number	Temperature Range	Package			
		H	N	J	D
LM118	-55, + 125°C	•	•	•	•
LM218	-40, + 105°C	•	•	•	•
LM318	0, + 70°C	•	•	•	•

Examples : LM118J, LM218H

PIN CONNECTIONS (top views)

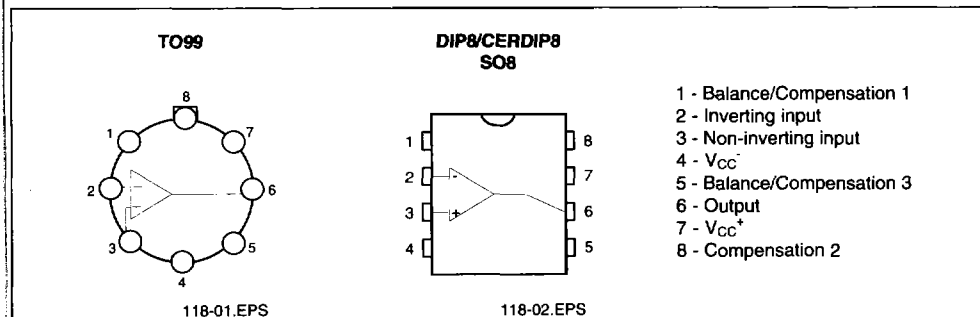

SCHEMATIC DIAGRAM

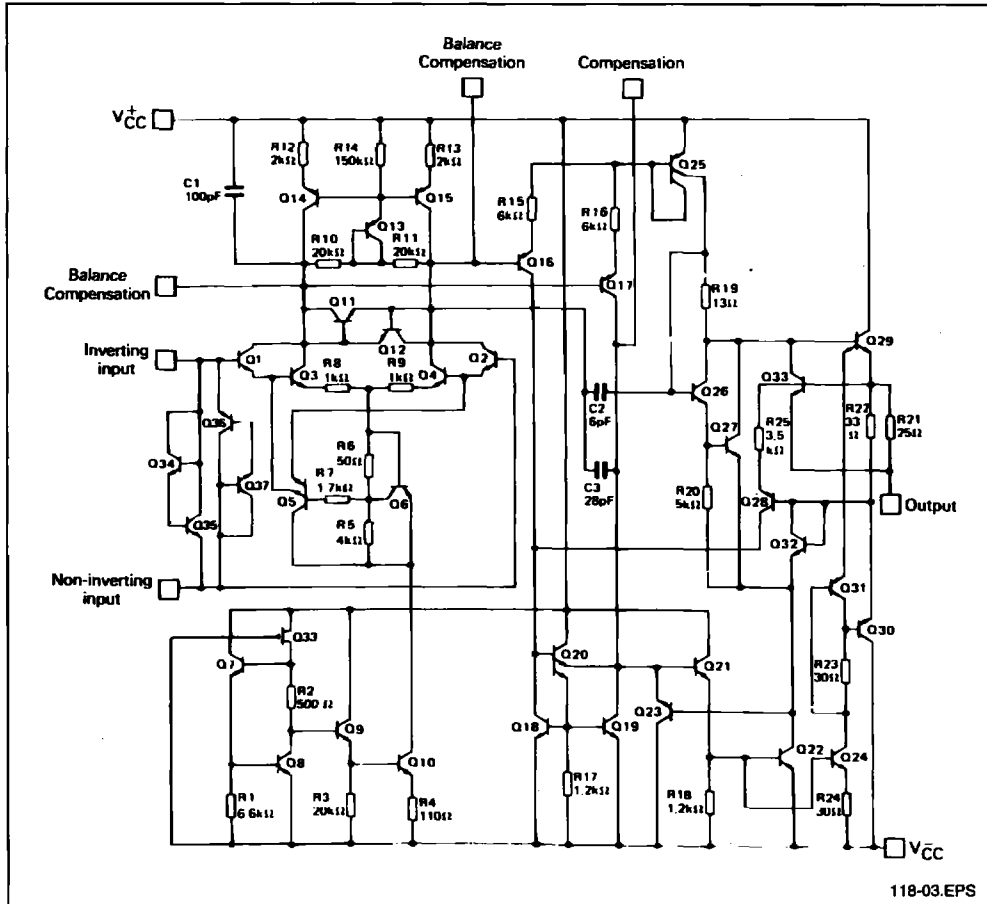

ABSOLUTE MAXIMUM RATINGS

Symbol	Parameter	LM118	LM218	LM318	Unit
V _{cc}	Supply Voltage	±20	±20	±20	V
V _i	Input Voltage - (note 1)	±15	±15	±15	V
I _{id}	Differential Input Current - (note 2)	±10	±10	±10	mA
	Output Short-circuit Duration	Infinite			
P _{tot}	Power Dissipation				mW
	LM318D			300	
	All other Versions	500	500	500	
T _{oper}	Operating Free-air Temperature Range	-55 to +125	-40 to +105	0 to +70	°C
T _{stg}	Storage Temperature Range	-65 to +150	-65 to +150	-65 to +150	°C

- Notes :
1. For supply voltage less than ±15V, the absolute maximum input voltage is equal to the supply voltage
 2. The inputs are shunted with shunt diodes for overvoltage protection. Therefore, excessive current will flow if a differential input voltage in excess of 1V is applied between the inputs unless some limiting resistance is used.

ELECTRICAL CHARACTERISTICS

 $\pm 5V \leq V_{CC} \leq \pm 20V$, $C_1 = 30pF$, $T_{amb} = 25^\circ C$ (unless otherwise specified)

Symbol	Parameter	LM118 - LM218			LM318			Unit
		Min.	Typ.	Max.	Min.	Typ.	Max.	
V_{io}	Input Offset Voltage ($R_S \leq 10k\Omega$) $T_{amb} = 25^\circ C$ $T_{min.} \leq T_{amb} \leq T_{max.}$		2	4 6		2	10 15	mV
I_{ib}	Input Bias Current $T_{amb} = 25^\circ C$ $T_{min.} \leq T_{amb} \leq T_{max.}$		160	250 500		160	500 750	nA
I_{io}	Input Offset Current $T_{amb} = 25^\circ C$ $T_{min.} \leq T_{amb} \leq T_{max.}$		6	50 100		6	200 300	nA
A_{vd}	Large Signal Voltage Gain ($V_{CC} = \pm 15V$, $V_O = \pm 10V$, $R_L = 2k\Omega$) $T_{amb} = 25^\circ C$ $T_{min.} \leq T_{amb} \leq T_{max.}$	50 25	200		25 20	200		V/mV
SVR	Supply Voltage Rejection Ratio ($R_S \leq 10k\Omega$) $T_{amb} = 25^\circ C$ $T_{min.} \leq T_{amb} \leq T_{max.}$	70 70	97		65 65	97		dB
I_{CC}	Supply Current, no Load $T_{amb} = 25^\circ C$ $T_{min.} \leq T_{amb} \leq T_{max.}$		5	8 15		5	10 15	mA
V_i	Input Voltage Range ($V_{CC} = \pm 15V$) $T_{amb} = 25^\circ C$ $T_{min.} \leq T_{amb} \leq T_{max.}$	-11.5 -11.5		11.5 11.5	-11.5 -11.5		11.5 11.5	V
CMR	Common Mode rejection Ratio ($R_S \leq 10k\Omega$) $T_{amb} = 25^\circ C$ $T_{min.} \leq T_{amb} \leq T_{max.}$	80 80	105		70 70	105		dB
I_{OS}	Output Short-circuit Current ($V_{CC} = \pm 15V$) $T_{amb} = 25^\circ C$	10	30	60	10	30	60	mA
$\pm V_{OPP}$	Output Voltage Swing ($V_{CC} = \pm 15V$, $R_L = 2k\Omega$) $T_{amb} = 25^\circ C$ $T_{min.} \leq T_{amb} \leq T_{max.}$	± 12 ± 12	± 13		± 12 ± 12	± 13		V
SR	Slew Rate ($V_{CC} = \pm 15V$, $V_i = \pm 10V$, $R_L = 2k\Omega$, $C_L = 100pF$, $T_{amb} = 25^\circ C$, unity gain) - (note 3)	50	70		50	70		V/ μs
R_i	Input Impedance	1	3		1	3		M Ω
GBP	Gain Bandwidth Product ($V_{CC} = \pm 15V$, $V_i = 10mV$, $R_L = 2k\Omega$, $C_L = 100pF$, $f = 100kHz$)		15			15		MHz
THD	Total Harmonic Distortion ($V_{CC} = \pm 15V$, $f = 1kHz$, $A_v = 20dB$, $R_L = 2k\Omega$, $V_O = 2V_{PP}$, $C_L = 100 pF$)		0.008			0.008		%
e_n	Equivalent Input Noise Voltage ($V_{CC} = \pm 15V$, $f = 1kHz$, $R_S = 100\Omega$)		17			17		$\frac{nV}{\sqrt{Hz}}$

Note : 3. May be improved up to 150V/ μs in inverting amplifier configuration (see basic diagrams).

118-03.TBL

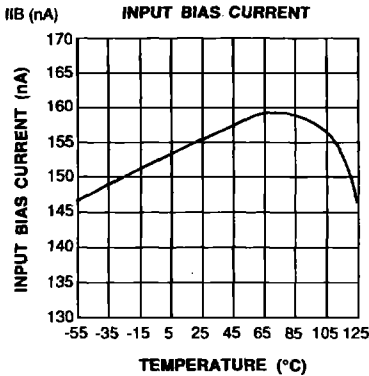

118-04.EPS

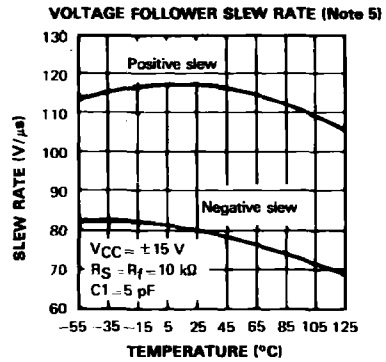

118-05.EPS

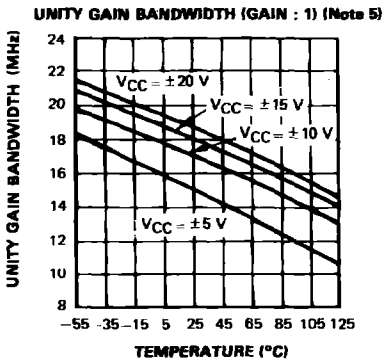

118-06.EPS

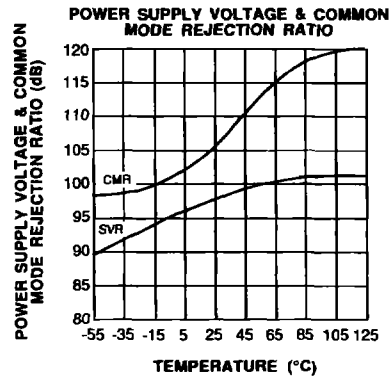

118-07.EPS

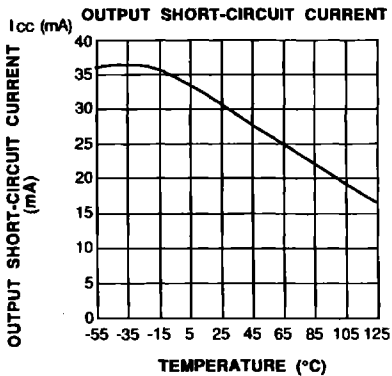

118-08.EPS

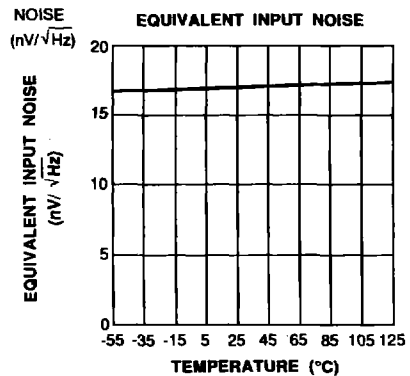

118-09.EPS

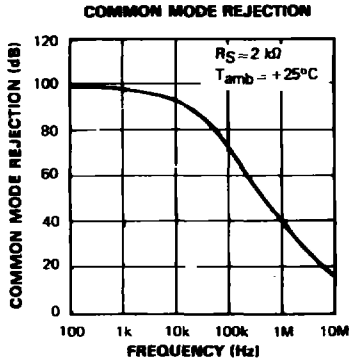

118-10.EPS

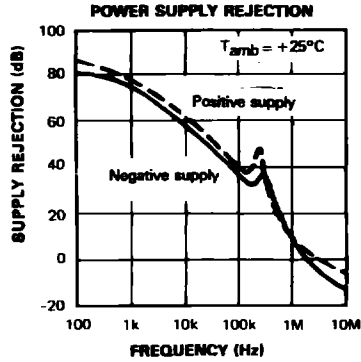

118-11.EPS

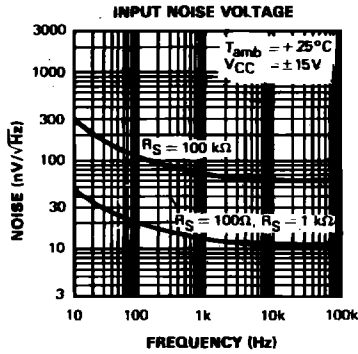

118-12.EPS

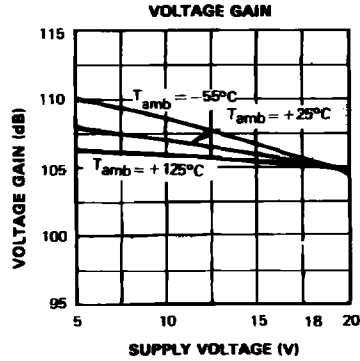

118-13.EPS

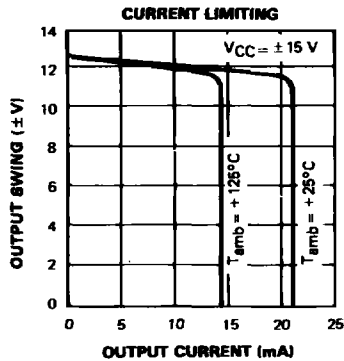

118-14.EPS

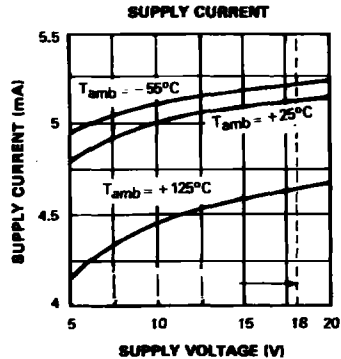

118-15.EPS

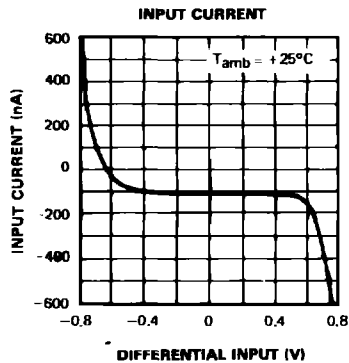

118-16.EPS

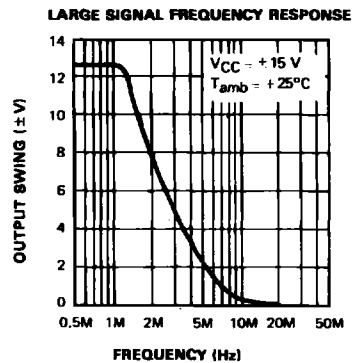

118-17.EPS

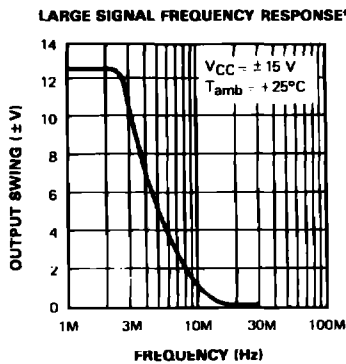

118-18.EPS

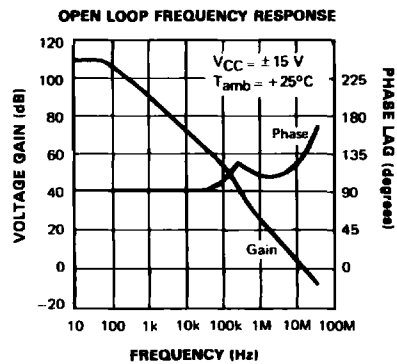

118-19.EPS

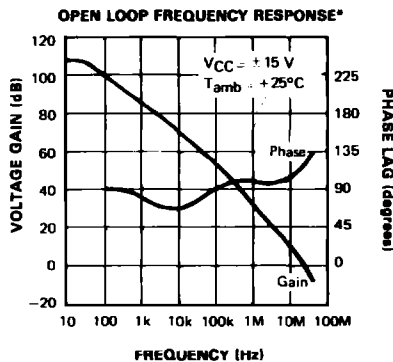

118-20.EPS

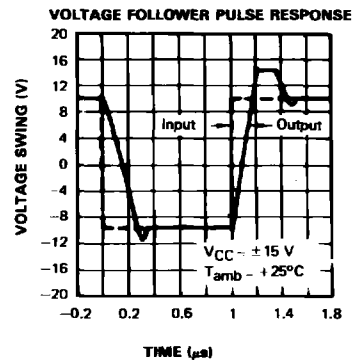

118-21.EPS

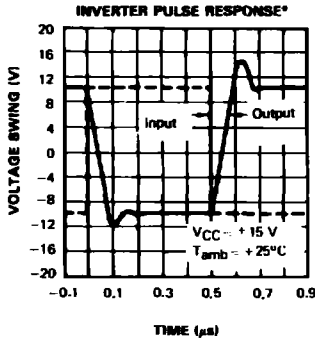

* With feedforward compensation

118-22.EPS

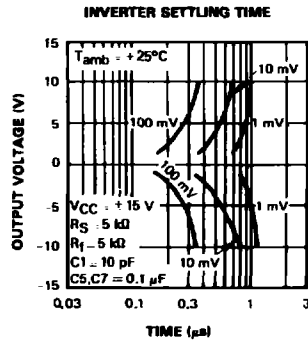

118-23.EPS

BASIC DIAGRAMS

FEEDFORWARD COMPENSATION FOR GREATER INVERTING SLEW RATE*

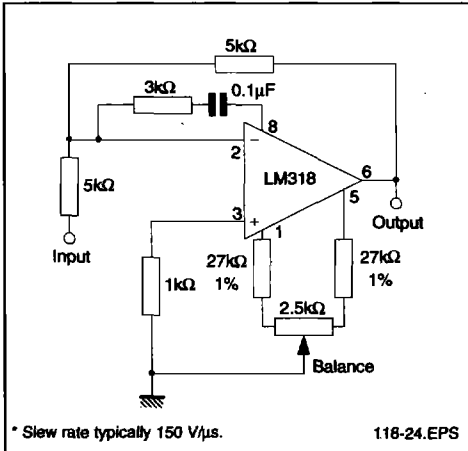

* Slew rate typically 150 V/µs.

118-24.EPS

COMPENSATION FOR MINIMUM SETTLING TIME*

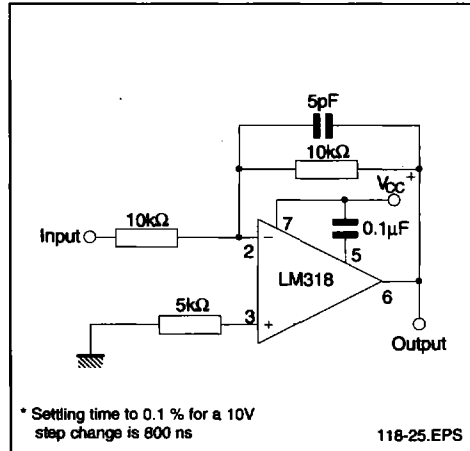

* Settling time to 0.1% for a 10V step change is 800 ns

118-25.EPS

ISOLATING LARGE CAPACITIVE LOADS

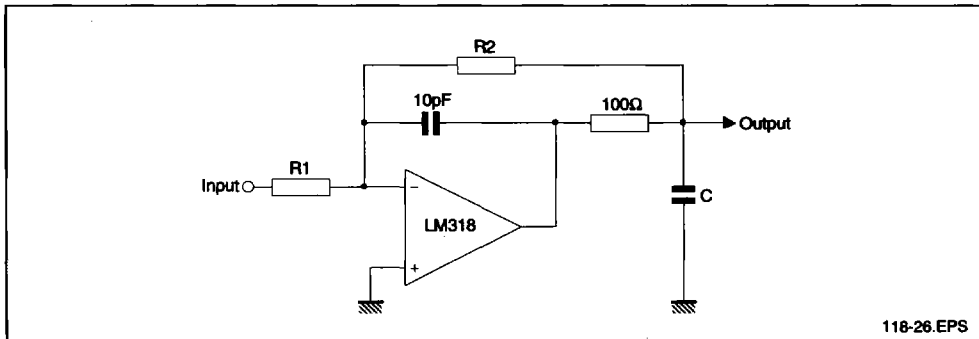

118-26.EPS

OFFSET BALANCING

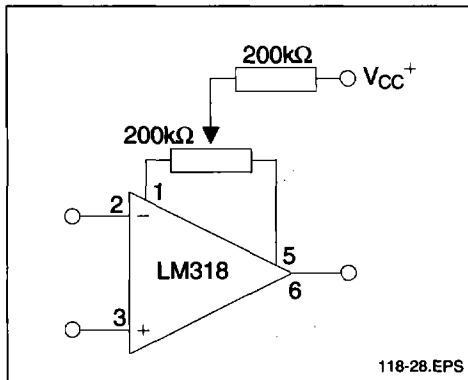

OVERCOMPENSATION

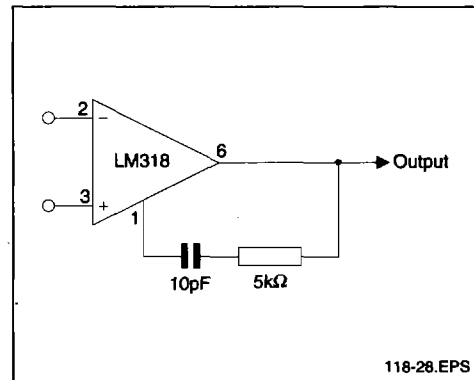

TYPICAL APPLICATION DIAGRAM

FAST SAMPLE AND HOLD

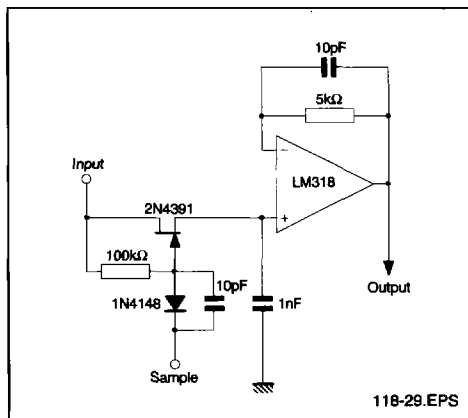

FAST SUMMING AMPLIFIER WITH LOW INPUT CURRENT

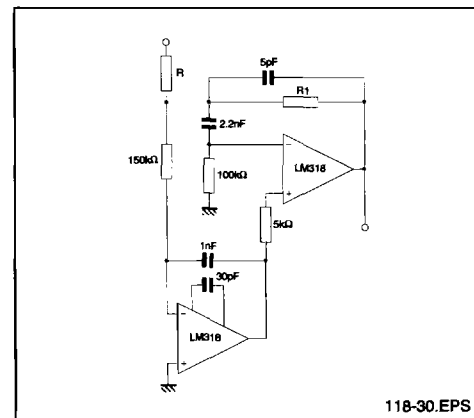

D/A CONVERTER USING LADDER NETWORK

