

# UTC BC556/557/558 PNP EPITAXIAL SILICON TRANSISTOR

## SWITCHING AND AMPLIFIER APPLICATIONS

### FEATURES

\* High Voltage: BC556,  $V_{CE0}=-65V$

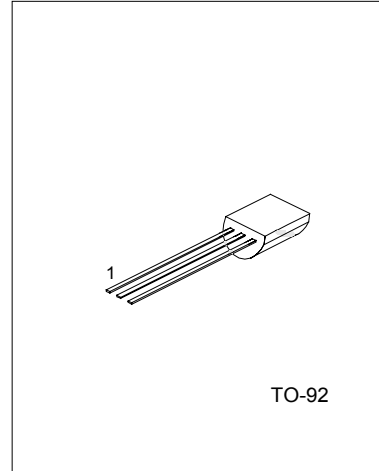

1: COLLECTOR 2: BASE 3: EMITTER

### ABSOLUTE MAXIMUM RATINGS ( $T_a=25^{\circ}C$ , unless otherwise specified)

PARAMETER	SYMBOL	RATING	UNIT
Collector-base voltage	$V_{CB0}$		
: BC556		-80	V
: BC557		-50	V
: BC558		-30	V
Collector-emitter voltage	$V_{CE0}$		
: BC556		-65	V
: BC557		-45	V
: BC558		-30	V
Emitter-base voltage	$V_{EB0}$	-5	V
Collector current (DC)	$I_c$	-100	mA
Collector dissipation	$P_c$	500	mW
Junction Temperature	$T_j$	150	$^{\circ}C$
Storage Temperature	$T_{STG}$	-65 ~ +150	$^{\circ}C$

### ELECTRICAL CHARACTERISTICS ( $T_a=25^{\circ}C$ , unless otherwise specified)

PARAMETER	SYMBOL	TEST CONDITIONS	MIN	TYP	MAX	UNIT
Collector Cut-off Current	$I_{CBO}$	$V_{CB}=-30V, I_E=0$			-15	nA
DC current gain	$h_{FE}$	$V_{CE}=-5V, I_c=2mA$	110		800	
Collector-emitter saturation voltage	$V_{CE(sat)}$	$I_c=-10mA, I_B=-0.5mA$ $I_c=-100mA, I_B=-5mA$		-90 -250	-300 -650	mV mV
Base-emitter saturation voltage	$V_{BE(sat)}$	$I_c=-10mA, I_B=-0.5mA$ $I_c=-100mA, I_B=-5mA$		-700 -900		mV
Base-emitter on voltage	$V_{BE(on)}$	$V_{CE}=-5V, I_c=-2mA$ $V_{CE}=-5V, I_c=-10mA$	-600	-660	-750 -800	mV mV
Current gain bandwidth product	$f_T$	$V_{CE}=-5V, I_c=-10mA, f=10MHz$		150		MHz
Output Capacitance	$C_{ob}$	$V_{CB}=-10V, I_E=0, f=1MHz$			6	pF

**UTC** UNISONIC TECHNOLOGIES CO., LTD. 1

QW-R201-051,A

## UTC BC556/557/558 PNP EPITAXIAL SILICON TRANSISTOR

PARAMETER	SYMBOL	TEST CONDITIONS	MIN	TYP	MAX	UNIT
Noise Figure	NF	$V_{CE}=-5V, I_C=-200\mu A,$ $f=1KHZ, R_G=2K\Omega$		2	10	dB

### CLASSIFICATION OF $h_{FE}$

RANK	A	B	C
$h_{FE}$	110 - 220	200 - 450	420 - 800

TYPICAL CHARACTERISTICS

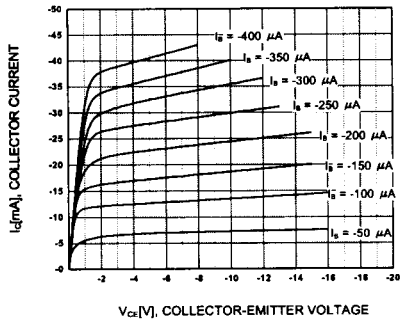

Figure 1. Static Characteristic

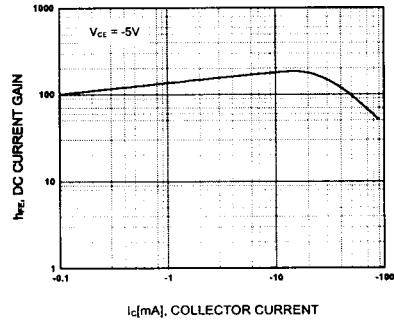

Figure 2. DC current Gain

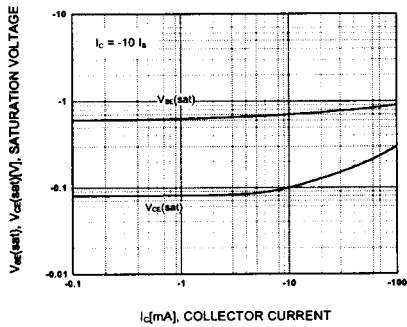

Figure 3. Base-Emitter Saturation Voltage  
Collector-Emitter Saturation Voltage

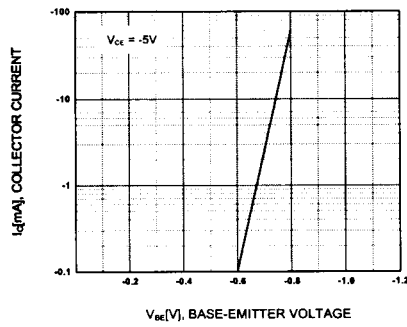

Figure 4. Base-Emitter On Voltage

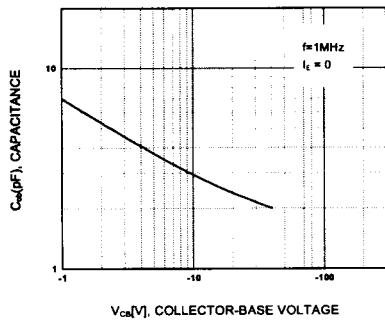

Figure 5. Collector Output Capacitance

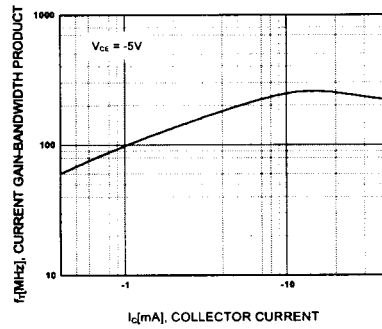

Figure 6. Current Gain Bandwidth Product

UTC assumes no responsibility for equipment failures that result from using products at values that exceed, even momentarily, rated values (such as maximum ratings, operating condition ranges, or other parameters) listed in products specifications of any and all UTC products described or contained herein. UTC products are not designed for use in life support appliances, devices or systems where malfunction of these products can be reasonably expected to result in personal injury. Reproduction in whole or in part is prohibited without the prior written consent of the copyright owner. The information presented in this document does not form part of any quotation or contract, is believed to be accurate and reliable and may be changed without notice.