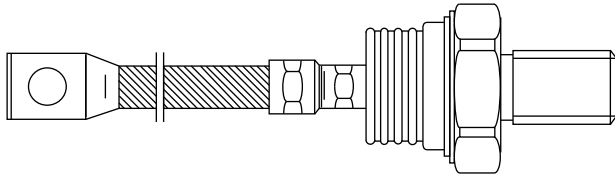

Standard Recovery Diodes, (Stud Version), 600 A

B-8
FEATURES

- Wide current range
- High voltage ratings up to 3200 V
- High surge current capabilities
- Stud cathode and stud anode version
- Standard JEDEC® types
- Compression bonded encapsulations
- Designed and qualified for industrial level
- Material categorization: for definitions of compliance please see www.vishay.com/doc?99912

**RoHS
COMPLIANT**
PRIMARY CHARACTERISTICS

$I_{F(AV)}$	600 A
Package	B-8
Circuit configuration	Single

TYPICAL APPLICATIONS

- Converters
- Power supplies
- Machine tool controls
- High power drives
- Medium traction applications

MAJOR RATINGS AND CHARACTERISTICS

PARAMETER	TEST CONDITIONS	SD600N/R		UNITS
		04 to 20	22 to 32	
$I_{F(AV)}$		600	600	A
	T_C	92	54	°C
$I_{F(RMS)}$		940	940	A
I_{FSM}	50 Hz	13 000	10 500	
	60 Hz	13 600	11 000	
I^2t	50 Hz	845	551	kA ² s
	60 Hz	772	503	
V_{RRM}	Range	400 to 2000	2200 to 3200	V
T_J		-40 to +180	-40 to +150	°C

ELECTRICAL SPECIFICATIONS
VOLTAGE RATINGS

TYPE NUMBER	VOLTAGE CODE	V_{RRM} , MAXIMUM REPETITIVE PEAK REVERSE VOLTAGE V	V_{RSM} , MAXIMUM NON-REPETITIVE PEAK REVERSE VOLTAGE V	I_{RRM} MAXIMUM AT $T_J = T_J$ MAXIMUM mA
VS-SD600N/R	04	400	500	35
	08	800	900	
	12	1200	1300	
	16	1600	1700	
	20	2000	2100	
	22	2200	2300	
	28	2800	2900	
	32	3200	3300	



FORWARD CONDUCTION							
PARAMETER	SYMBOL	TEST CONDITIONS	SD600N/R		UNITS		
			04 to 20	22 to 32			
Maximum average forward current at case temperature	$I_{F(AV)}$	180° conduction, half sine wave	600		A		
			92	54	°C		
			570	375	A		
			100		°C		
Maximum RMS forward current	$I_{F(RMS)}$	DC at $T_C = 75\text{ °C}$ (04 to 20), $T_C = 36\text{ °C}$ (25 to 32)	940				
Maximum peak, one-cycle forward, non-repetitive surge current	I_{FSM}	Sinusoidal half wave, initial $T_J = T_J$ maximum	t = 10 ms	No voltage reapplied	13 000	10 500	A
			t = 8.3 ms		13 600	11 000	
			t = 10 ms	100 % V_{RRM} reapplied	10 900	8830	
			t = 8.3 ms		11 450	9250	
Maximum I^2t for fusing	I^2t		t = 10 ms	No voltage reapplied	845	551	kA ² s
			t = 8.3 ms		772	503	
			t = 10 ms	100 % V_{RRM} reapplied	598	390	
			t = 8.3 ms		546	356	
Maximum $I^2\sqrt{t}$ for fusing	$I^2\sqrt{t}$	t = 0.1 to 10 ms, no voltage reapplied	8450	5510	kA ² √s		
Low level value of threshold voltage	$V_{F(TO)1}$	($16.7\% \times \pi \times I_{F(AV)} < I < \pi \times I_{F(AV)}$), $T_J = T_J$ maximum	0.78	0.84	V		
High level value of threshold voltage	$V_{F(TO)2}$	($I > \pi \times I_{F(AV)}$), $T_J = T_J$ maximum	0.87	0.88			
Low level value of forward slope resistance	r_{f1}	($16.7\% \times \pi \times I_{F(AV)} < I < \pi \times I_{F(AV)}$), $T_J = T_J$ maximum	0.35	0.40	mW		
High level value of forward slope resistance	r_{f2}	($I > \pi \times I_{F(AV)}$), $T_J = T_J$ maximum	0.31	0.38			
Maximum forward voltage drop	V_{FM}	$I_{pk} = 1500\text{ A}$, $T_J = T_J$ maximum, $t_p = 10\text{ ms}$ sinusoidal wave	1.31	1.44	V		

THERMAL AND MECHANICAL SPECIFICATIONS					
PARAMETER	SYMBOL	TEST CONDITIONS	SD600N/R		UNITS
			04 to 20	22 to 32	
Maximum junction operating temperature range	T_J		-40 to 180	-40 to 150	°C
Maximum storage temperature range	T_{Stg}		-55 to 200		
Maximum thermal resistance, junction to case	R_{thJC}	DC operation	0.1		K/W
Maximum thermal resistance, case to heatsink	R_{thCS}	Mounting surface, smooth, flat and greased	0.04		
Maximum allowed mounting torque ± 10 %		Not-lubricated threads	50		Nm
Approximate weight			454		g
Case style		See dimensions (link at the end of datasheet)	B-8		

ΔR_{thJC} CONDUCTION				
CONDUCTION ANGLE	SINUSOIDAL CONDUCTION	RECTANGULAR CONDUCTION	TEST CONDITIONS	UNITS
180°	0.012	0.008	$T_J = T_J$ maximum	K/W
120°	0.014	0.014		
90°	0.017	0.019		
60°	0.025	0.026		
30°	0.042	0.042		

Note

- The table above shows the increment of thermal resistance R_{thJC} when devices operate at different conduction angles than DC

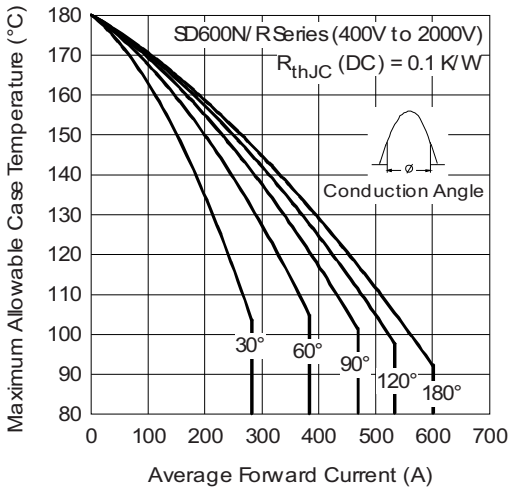

Fig. 1 - Current Ratings Characteristics

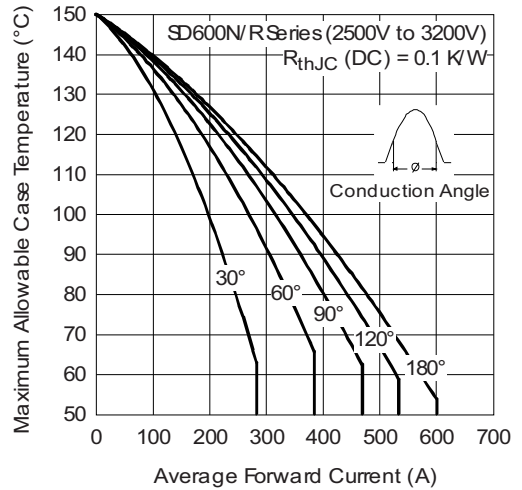

Fig. 3 - Current Ratings Characteristics

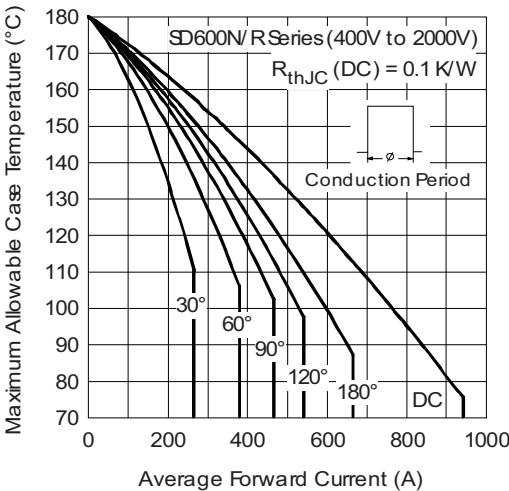

Fig. 2 - Current Ratings Characteristics

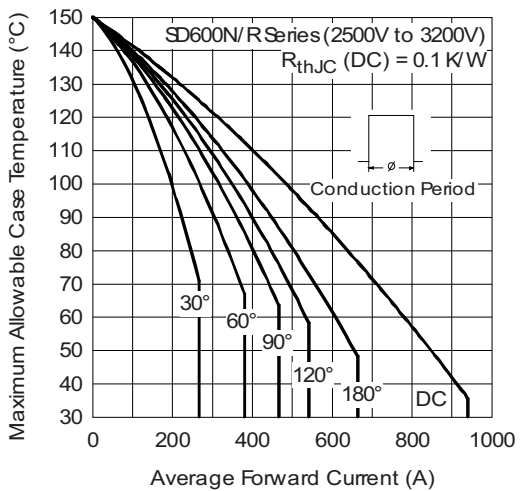

Fig. 4 - Current Ratings Characteristics

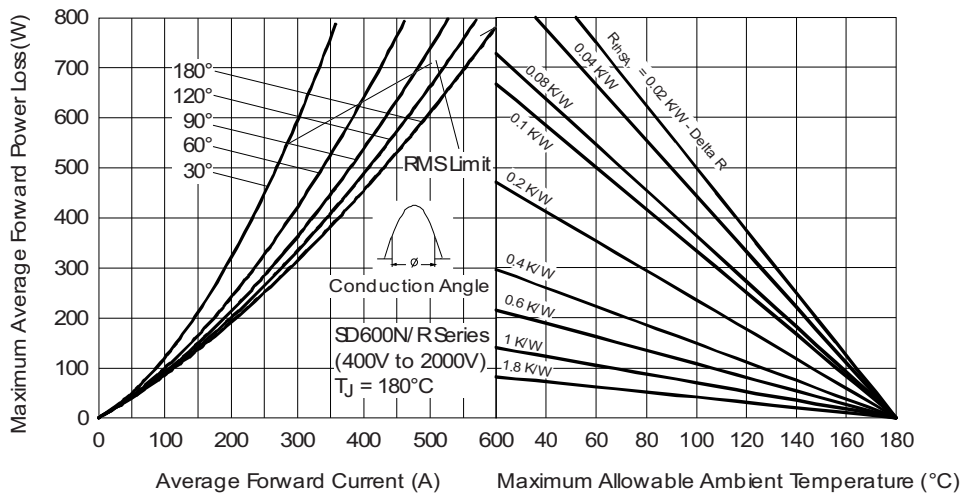

Fig. 5 - Forward Power Loss Characteristics

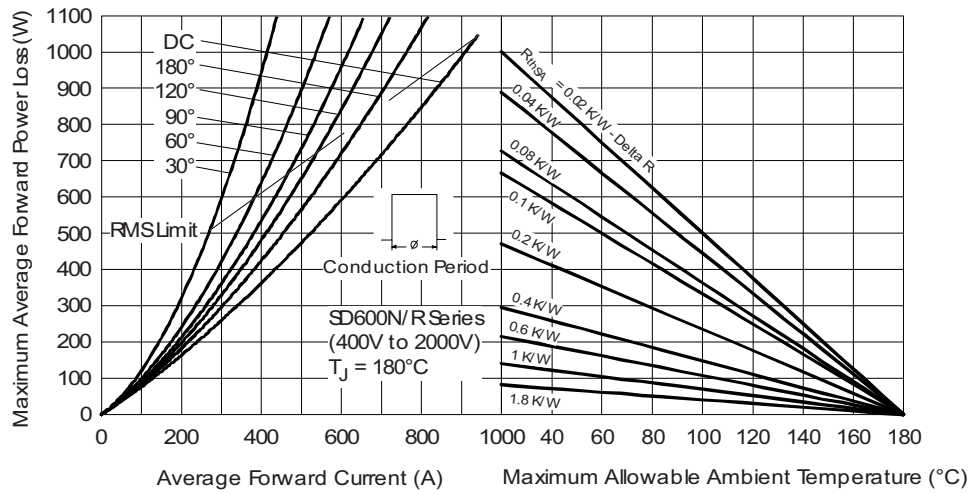

Fig. 6 - Forward Power Loss Characteristics

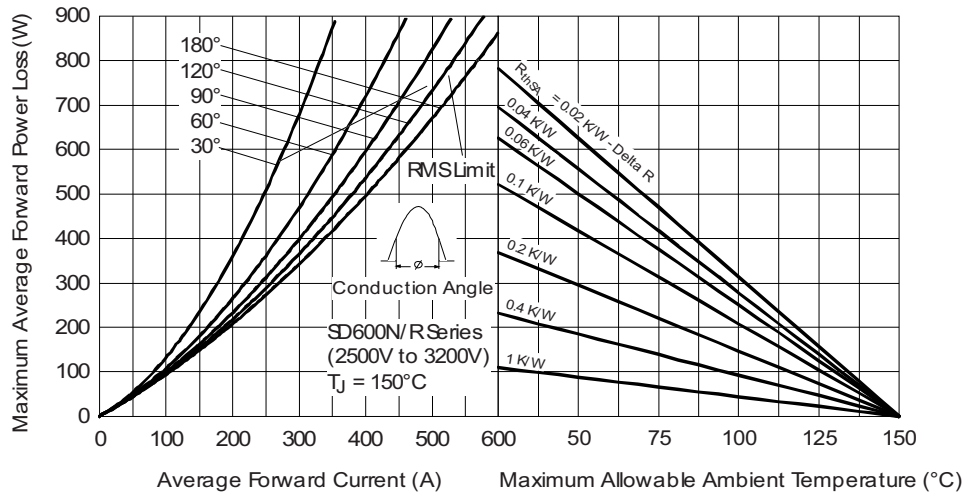

Fig. 7 - Forward Power Loss Characteristics

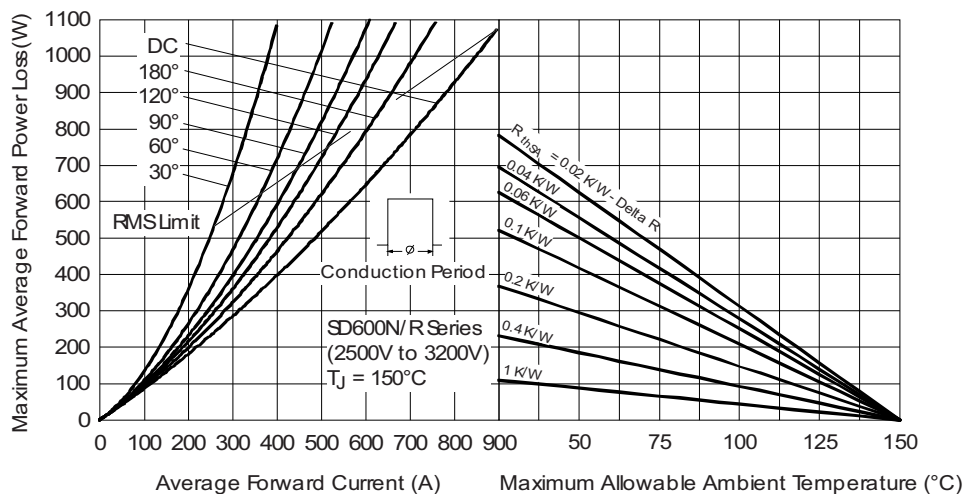

Fig. 8 - Forward Power Loss Characteristics

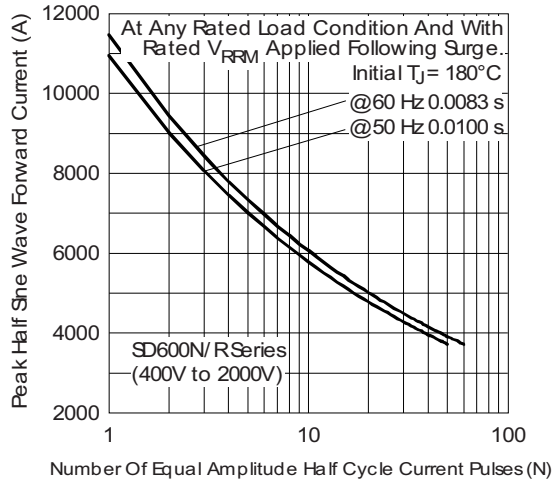

Fig. 9 - Maximum Non-Repetitive Surge Current

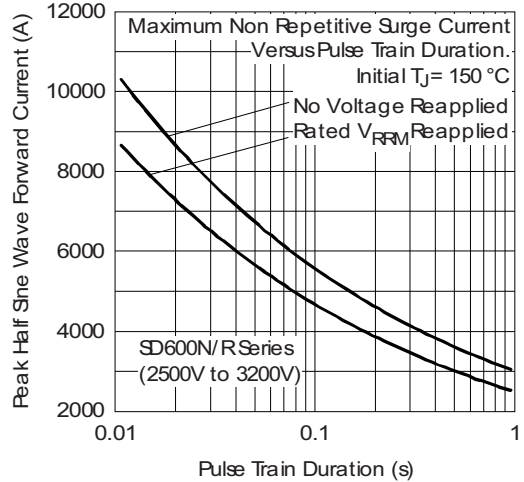

Fig. 12 - Maximum Non-Repetitive Surge Current

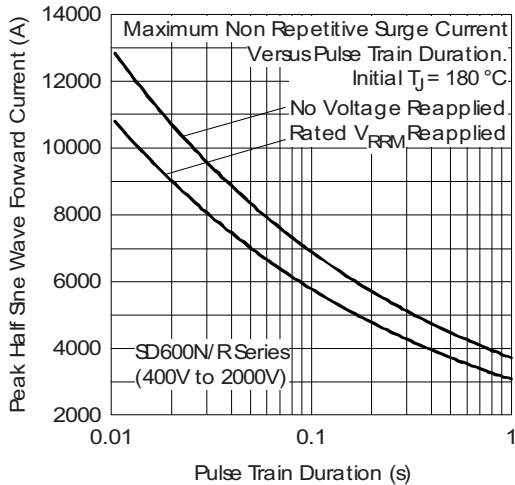

Fig. 10 - Maximum Non-Repetitive Surge Current

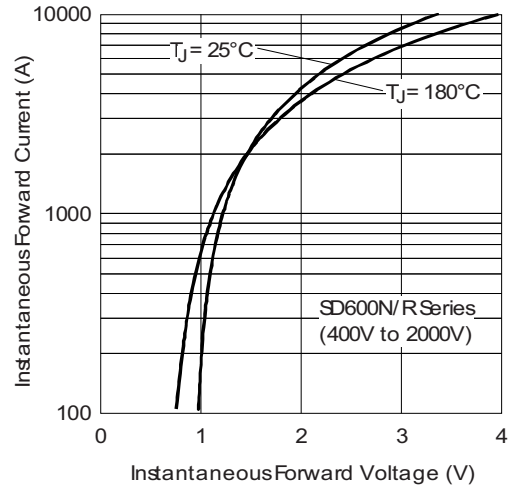

Fig. 13 - Forward Voltage Drop Characteristics

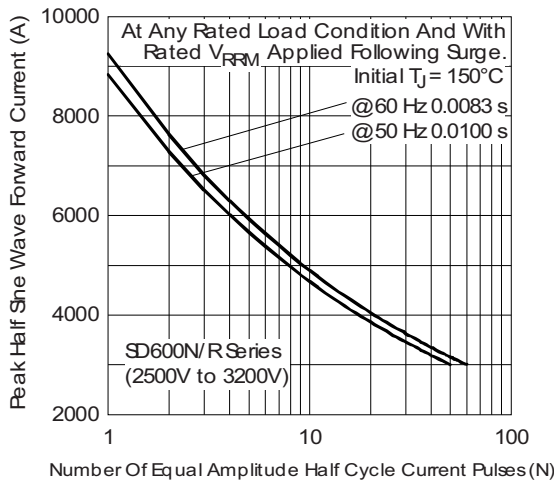

Fig. 11 - Maximum Non-Repetitive Surge Current

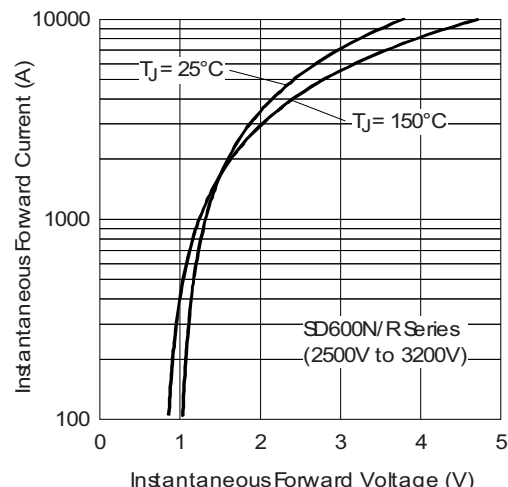

Fig. 14 - Forward Voltage Drop Characteristics

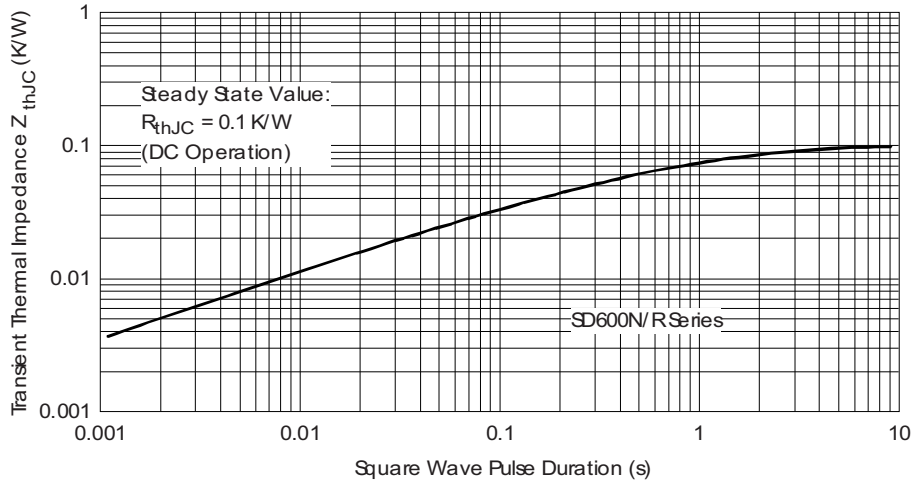

Fig. 15 - Thermal Impedance Z_{thJC} Characteristics

ORDERING INFORMATION TABLE

Device code	VS-	SD	60	0	N	32	P	C
	①	②	③	④	⑤	⑥	⑦	⑧

- 1** - Vishay Semiconductors product
- 2** - Diode
- 3** - Essential part number
- 4** - 0 = standard recovery
- 5** - • N = stud normal polarity (cathode to stud)
• R = stud reverse polarity (anode to stud)
- 6** - Voltage code x 100 = V_{RRM} (see Voltage Ratings table)
- 7** - P = stud base B-8 3/4" 16UNF-2A
- 8** - C = ceramic cap

For metric device M24 x 1.5 contact factory

LINKS TO RELATED DOCUMENTS	
Dimensions	www.vishay.com/doc?95303

B-8

DIMENSIONS in millimeters (inches)

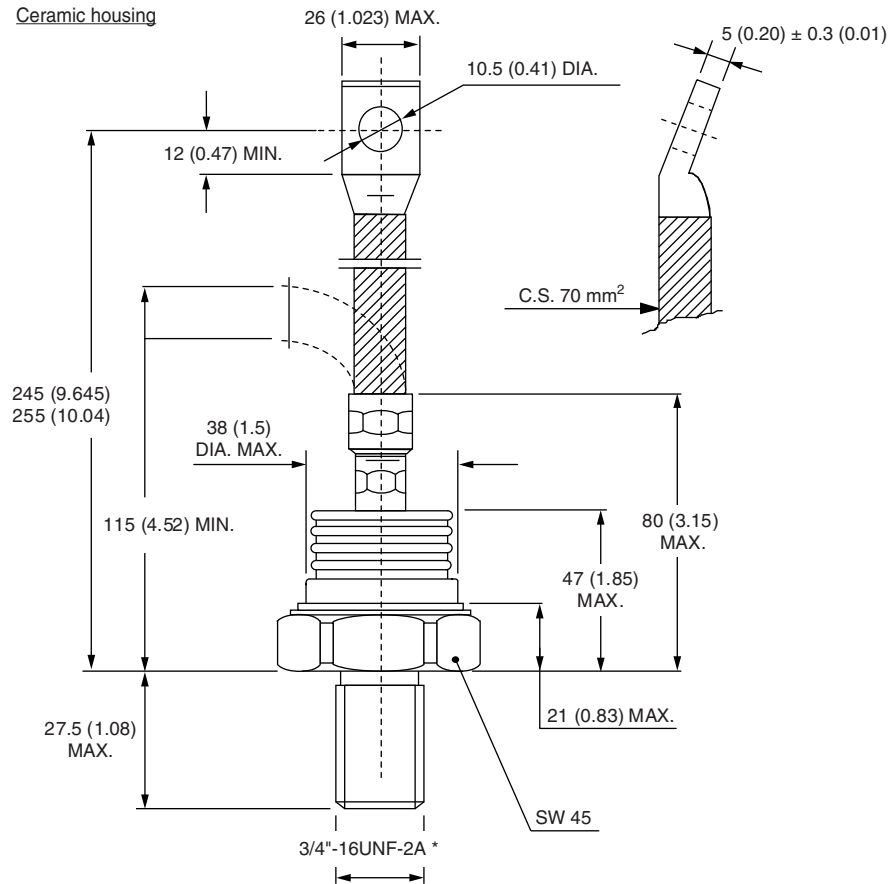

*For metric device: M24 x 1.5 - length 21 (0.83) MAX.
contact factory



Disclaimer

ALL PRODUCT, PRODUCT SPECIFICATIONS AND DATA ARE SUBJECT TO CHANGE WITHOUT NOTICE TO IMPROVE RELIABILITY, FUNCTION OR DESIGN OR OTHERWISE.

Vishay Intertechnology, Inc., its affiliates, agents, and employees, and all persons acting on its or their behalf (collectively, "Vishay"), disclaim any and all liability for any errors, inaccuracies or incompleteness contained in any datasheet or in any other disclosure relating to any product.

Vishay makes no warranty, representation or guarantee regarding the suitability of the products for any particular purpose or the continuing production of any product. To the maximum extent permitted by applicable law, Vishay disclaims (i) any and all liability arising out of the application or use of any product, (ii) any and all liability, including without limitation special, consequential or incidental damages, and (iii) any and all implied warranties, including warranties of fitness for particular purpose, non-infringement and merchantability.

Statements regarding the suitability of products for certain types of applications are based on Vishay's knowledge of typical requirements that are often placed on Vishay products in generic applications. Such statements are not binding statements about the suitability of products for a particular application. It is the customer's responsibility to validate that a particular product with the properties described in the product specification is suitable for use in a particular application. Parameters provided in datasheets and / or specifications may vary in different applications and performance may vary over time. All operating parameters, including typical parameters, must be validated for each customer application by the customer's technical experts. Product specifications do not expand or otherwise modify Vishay's terms and conditions of purchase, including but not limited to the warranty expressed therein.

Except as expressly indicated in writing, Vishay products are not designed for use in medical, life-saving, or life-sustaining applications or for any other application in which the failure of the Vishay product could result in personal injury or death. Customers using or selling Vishay products not expressly indicated for use in such applications do so at their own risk. Please contact authorized Vishay personnel to obtain written terms and conditions regarding products designed for such applications.

No license, express or implied, by estoppel or otherwise, to any intellectual property rights is granted by this document or by any conduct of Vishay. Product names and markings noted herein may be trademarks of their respective owners.