

HP Series 1.25mm Spacing SMT Plug

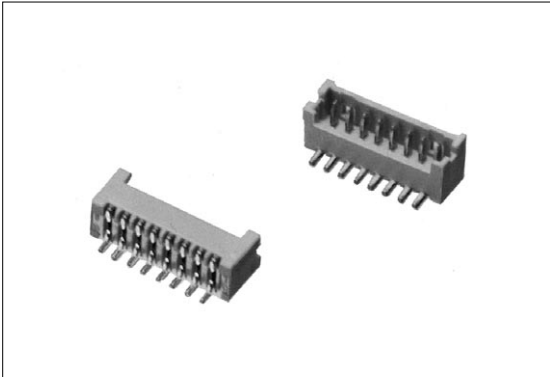

Features

1. This reflow connectors in this series apply to the HP connectors and most suitable for high-density mounting.
2. The connectors are fed also in the embossed taping to cope with automatic mounter.

Specifications

1. Rating : AC/DC 125V 1A
2. Contact Resistance : 20mΩ max
3. Insulation Resistance : 1000MΩmin. at 500V DC
4. Withstanding Voltage : 500V AC for one minute
5. Operating Temperature Range : -25°C to +85°C

Note

Custom made models will be available upon request.

Taping Dimensions

Straight Type CHP 25□□-0101

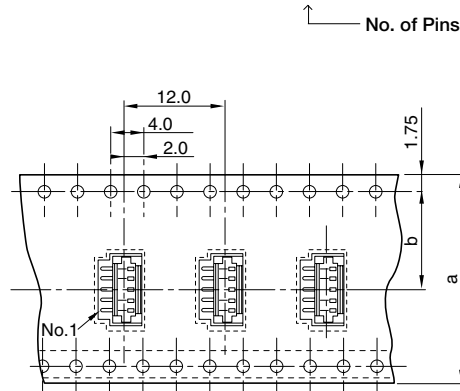

□□ No. of Pins	a	b	Plug Part No.
02	12	5.5	CHP2502-0101
03			CHP2503-0101
04			CHP2504-0101
05	16	7.5	CHP2505-0101
06			CHP2506-0101
07			CHP2507-0101
08			CHP2508-0101
09	24	11.5	CHP2509-0101
10			CHP2510-0101
12			CHP2512-0101
13			CHP2513-0101
15			CHP2515-0101
32	14.2		CHP2515-0101

Right-Angle Type CHP 27□□-0101

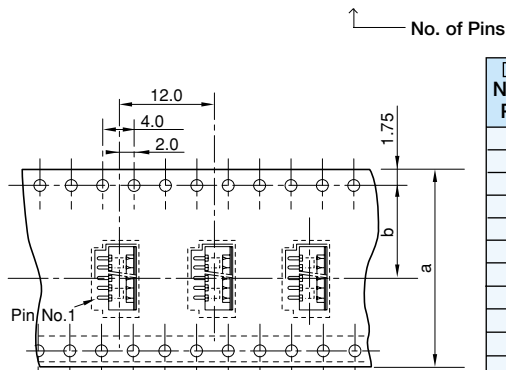

□□ No. of Pins	a	b	Pulg Part No.
02	12	5.5	CHP2702-0101
03			CHP2703-0101
04	16	7.5	CHP2704-0101
05			CHP2705-0101
06			CHP2706-0101
07			CHP2707-0101
08	24	11.5	CHP2708-0101
09			CHP2709-0101
10			CHP2710-0101
12			CHP2712-0101
13			CHP2713-0101
15	32	14.2	CHP2715-0101

Applicable Pattern on PC Board

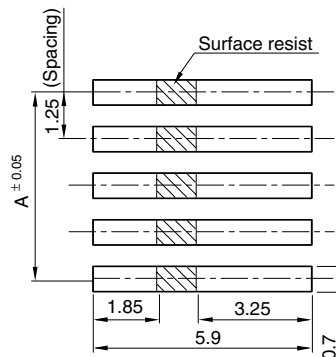

● Plug

No. of Pins	Straight Type	Right-Angle Type	A	B
2	CHP2502-0101	CHP2702-0101	1.25	4.25
3	CHP2503-0101	CHP2703-0101	2.50	5.50
4	CHP2504-0101	CHP2704-0101	3.75	6.75
5	CHP2505-0101	CHP2705-0101	5.00	8.00
6	CHP2506-0101	CHP2706-0101	6.25	9.25
7	CHP2507-0101	CHP2707-0101	7.50	10.50
8	CHP2508-0101	CHP2708-0101	8.75	11.75
9	CHP2509-0101	CHP2709-0101	10.00	13.00
10	CHP2510-0101	CHP2710-0101	11.25	14.25
12	CHP2512-0101	CHP2712-0101	13.75	16.75
13	CHP2513-0101	CHP2713-0101	15.00	18.00
15	CHP2515-0101	CHP2715-0101	17.50	20.50

■ Material and Plating

- Housing : Polyamide 46 with 30% of Glass
- Plug Pin : Copper Alloy Tin-lead Plating

Straight Type

CHP25□□-0101

↑ No. of Pins

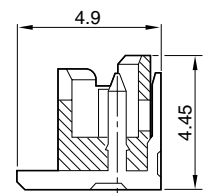
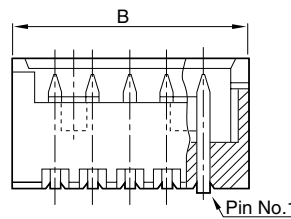
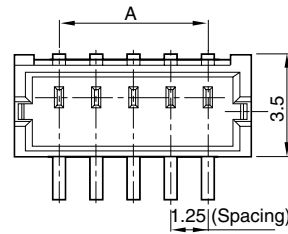

Right-Angle Type

CHP27□□-0101

↑ No. of Pins

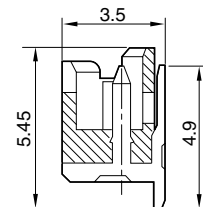
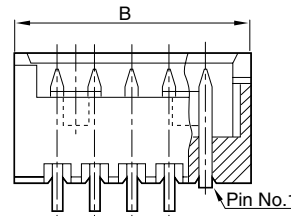

■ Reel Dimensions 1000pcs/reel

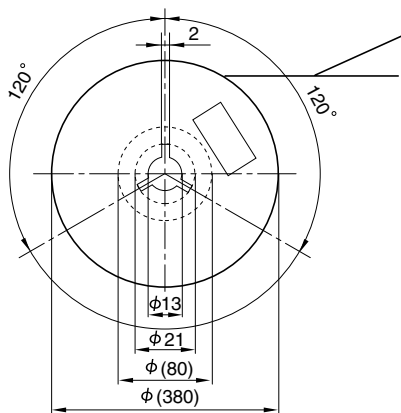

■ Reflow Soldering Conditions

