

R1110N SERIES

OUTLINE

The R1110N Series are voltage regulator ICs with high output voltage accuracy, lowest supply current, low ON Resistance and high Ripple Rejection by CMOS process. Each of these voltage regulator ICs consists of a voltage reference unit, an error amplifier, resistors, a current limit circuit and a chip enable circuit.

These ICs perform with low dropout voltage and a chip enable function.

The Dynamic Response to line and load is fast, so these ICs are very suitable for the power supply for handheld communication equipment.

The output voltage of these ICs is fixed with high accuracy.

Since the package for these ICs are SOT-23-5 (Mini-mold) package, high density mounting of the ICs on boards is possible.

FEATURES

- Ultra-Low Supply CurrentTYP. 35 μ A
- Standby CurrentTYP. 0.1 μ A
- Dropout VoltageTYP. 0.2V ($I_{OUT}=100\text{mA}$)
- High Ripple RejectionTYP. 70dB ($f=1\text{kHz}$)
- High Accuracy Output Voltage $\pm 2.0\%$
- Low Temperature-Drift Coefficient of
Output VoltageTYP. $\pm 100\text{ppm}/^{\circ}\text{C}$
- Excellent Line RegulationTYP. 0.05%/V
- PinoutSimilar to the LP2980
- Small PackageSOT-23-5 (Mini-mold)

APPLICATIONS

- Power source for portable communication tools, cameras and VCRs.
- Power source for battery-powered equipment.
- Power source for domestic appliances.

BLOCK DIAGRAM

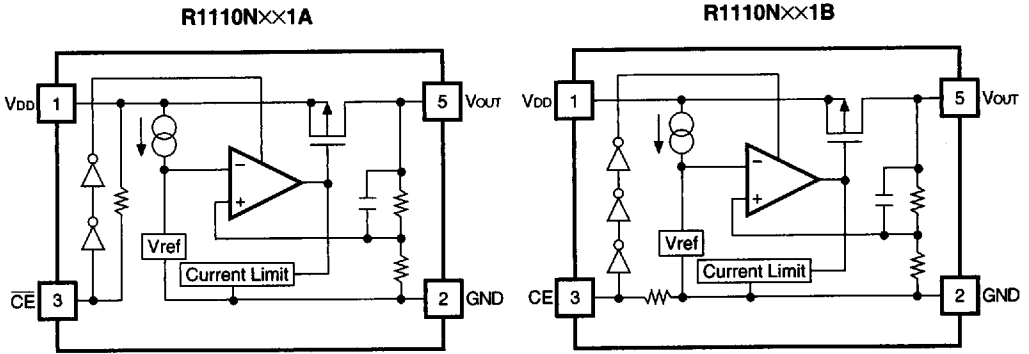

SELECTION GUIDE

The output voltage, the active type, the packing type and the taping type for the ICs can be selected at the user's request. The selection can be made by designating the part number as shown below:

R1110N××1×-×× ← Part Number
 ↑ ↑ ↑
 a b c

Code	Contents
a	Setting Output Voltage (V_{OUT}) : Stepwise setting with a step of 0.1V in the range of 2.0V to 6.0V is possible.
b	Designation of Chip enable Active Type : A : "L" active type B : "H" active type
c	Designation of Taping Type : Ex. TR, TL (refer to Taping Specifications, TR type is prescribed as a standard.)

PIN CONFIGURATION

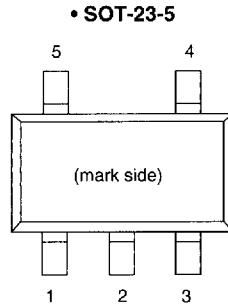

PIN DESCRIPTION

Pin No.	Symbol	Pin Description
1	VDD	Input Pin
2	GND	Ground Pin
3	CE or $\overline{\text{CE}}$	Chip Enable Pin
4	NC	No Connection
5	VOUT	Output Pin

ABSOLUTE MAXIMUM RATINGS

Symbol	Item	Rating	Unit
V _{IN}	Input Voltage	9	V
V _{CE}	Input Voltage for CE/ $\overline{\text{CE}}$ Pin	-0.3 to V _{IN} +0.3	V
V _{OUT}	Output Voltage	-0.3 to V _{IN} +0.3	V
I _{OUT}	Output Current	200	mA
P _D	Power Dissipation	250	mW
T _{opt}	Operating Temperature Range	-40 to 85	°C
T _{stg}	Storage Temperature Range	-55 to 125	°C

ABSOLUTE MAXIMUM RATINGS

Absolute Maximum ratings are threshold limit values that must not be exceeded even for an instant under any conditions. Moreover, such values for any two items must not be reached simultaneously. Operation above these absolute maximum ratings may cause degradation or permanent damage to the device. These are stress ratings only and do not necessarily imply functional operation below these limits.

ELECTRICAL CHARACTERISTICS

• R1110N××A

T_{opt}=25°C

Symbol	Item	Conditions	MIN.	TYP.	MAX.	Unit
V _{OUT}	Output Voltage	V _{IN} -setV _{OUT} =1.0V 1mA≤I _{OUT} ≤30mA	×0.98		×1.02	V
I _{OUT}	Output Current	V _{IN} -setV _{OUT} =1.0V when V _{OUT} =setV _{OUT} -0.1V	150			mA
$\frac{\Delta V_{OUT}}{\Delta I_{OUT}}$	Load Regulation	V _{IN} -setV _{OUT} =1.0V 1mA≤I _{OUT} ≤80mA		12	40	mV
V _{DIF}	Dropout Voltage	refer to the ELECTRICAL CHARACTERISTICS by OUTPUT VOLTAGE				
I _{SS}	Supply Current	V _{IN} -setV _{OUT} =1.0V		35	70	μA
I _{standby}	Standby Current	V _{IN} -setV _{OUT} =1.0V, V _{CE} =V _{IN}		0.1	1.0	μA
$\frac{\Delta V_{OUT}}{\Delta V_{IN}}$	Line Regulation	refer to the ELECTRICAL CHARACTERISTICS by OUTPUT VOLTAGE				
RR	Ripple Rejection	f=1kHz, Ripple 0.5Vp-p V _{IN} -setV _{OUT} =1.0V		70		dB
V _{IN}	Input Voltage		2.7		8	V
$\frac{\Delta V_{OUT}}{\Delta T_{opt}}$	Output Voltage Temperature Coefficient	I _{OUT} =30mA -40°C≤T _{opt} ≤85°C		±100		ppm/°C
I _{lim}	Short Current Limit	V _{OUT} =0V		50		mA
R _{PU}	Pull up resistance for \overline{CE} pin		2.5	5	10	MΩ
V _{CEH}	\overline{CE} Input Voltage "H"		1.5		V _{IN}	V
V _{CEL}	\overline{CE} Input Voltage "L"		0		0.25	V
en	Output Noise	BW=10Hz to 100kHz		60		μV _{rms}

R1110N

• R1110N××B

T_{opt}=25°C

Symbol	Item	Conditions	MIN.	TYP.	MAX.	Unit
V _{OUT}	Output Voltage	V _{IN} -setV _{OUT} =1.0V 1mA≤I _{OUT} ≤30mA	×0.98		×1.02	V
I _{OUT}	Output Current	V _{IN} -setV _{OUT} =1.0V when V _{OUT} =setV _{OUT} -0.1V	150			mA
$\frac{\Delta V_{OUT}}{\Delta I_{OUT}}$	Load Regulation	V _{IN} -setV _{OUT} =1.0V 1mA≤I _{OUT} ≤80mA		12	40	mV
V _{DIF}	Dropout Voltage	refer to the ELECTRICAL CHARACTERISTICS by OUTPUT VOLTAGE				
I _{SS}	Supply Current	V _{IN} -setV _{OUT} =1.0V		35	70	μA
I _{standby}	Standby Current	V _{IN} -setV _{OUT} =1.0V, V _{CE} =GND		0.1	1.0	μA
$\frac{\Delta V_{OUT}}{\Delta V_{IN}}$	Line Regulation	refer to the ELECTRICAL CHARACTERISTICS by OUTPUT VOLTAGE				
RR	Ripple Rejection	f=1kHz, Ripple 0.5Vp-p V _{IN} -setV _{OUT} =1.0V		70		dB
V _{IN}	Input Voltage		2.7		8	V
$\frac{\Delta V_{OUT}}{\Delta T_{opt}}$	Output Voltage Temperature Coefficient	I _{OUT} =30mA -40°C≤T _{opt} ≤85°C		±100		ppm/°C
I _{lim}	Short Current Limit	V _{OUT} =0V		50		mA
R _{PD}	Pull down resistance for \overline{CE} pin		2.5	5	10	MΩ
V _{CEH}	\overline{CE} Input Voltage "H"		1.5		V _{IN}	V
V _{CEL}	\overline{CE} Input Voltage "L"		0		0.25	V
en	Output Noise	BW=10Hz to 100kHz		60		μV _{rms}

• ELECTRICAL CHARACTERISTICS by OUTPUT VOLTAGE

T_{opt}=25°C

Output Voltage V _{out} (V)	Dropout Voltage			Line Regulation		
	V _{DIF} (V)			ΔV _{out} /ΔV _{in} (%/V)		
	Conditions	TYP.	MAX.	Conditions	TYP.	MAX.
2.0≤V _{OUT} ≤2.4	I _{OUT} =100mA	0.30	0.70	I _{OUT} =30mA setV _{OUT} +0.7V≤V _{IN} ≤8V	0.05	0.20
2.5≤V _{OUT} ≤2.7		0.24	0.35			
2.8≤V _{OUT} ≤3.3		0.20	0.30	I _{OUT} =30mA setV _{OUT} +0.5V≤V _{IN} ≤8V		
3.4≤V _{OUT} ≤6.0		0.17	0.26			

7744690 0004027 507

RIKOH

OPERATION

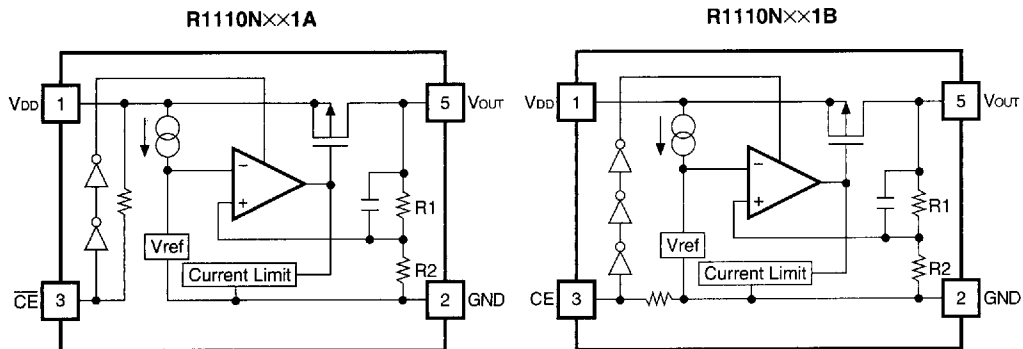

In these ICs, fluctuation in Output Voltage V_{OUT} is detected by Feed-back Registers R1, R2, and the result is compare with a reference voltage by Error Amplifier, so that a constant voltage is output.

A current limit circuit working for Short Protect and a chip enable circuit are included.

TEST CIRCUITS

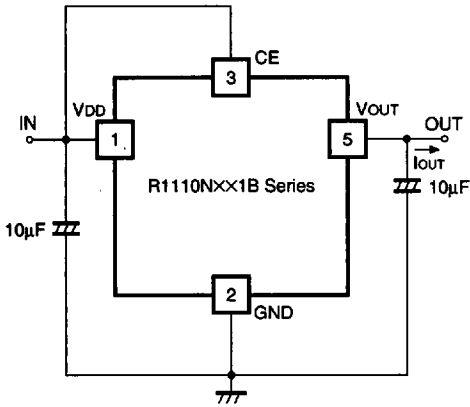

Standard Test Circuit

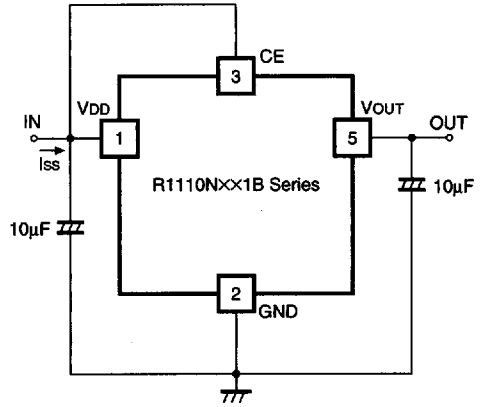

Test Circuit for Supply Current

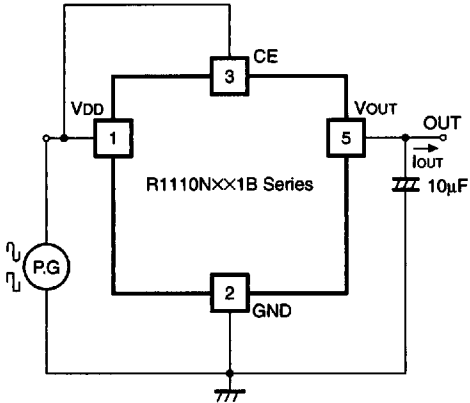

Test Circuit for Ripple Rejection and Line Transient Response

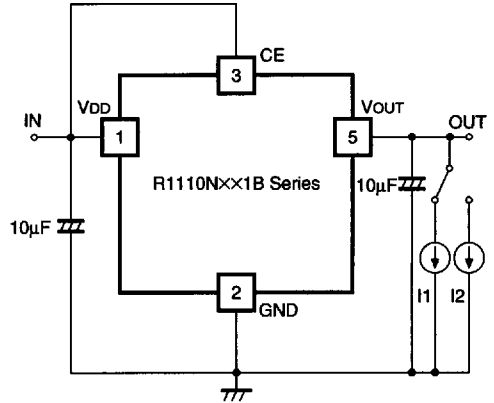

Test Circuit for Load Transient Response

TYPICAL CHARACTERISTICS

1) Output Voltage vs. Output Current

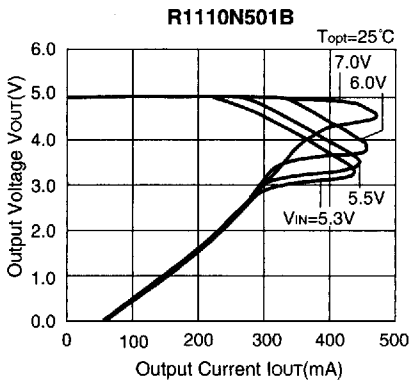
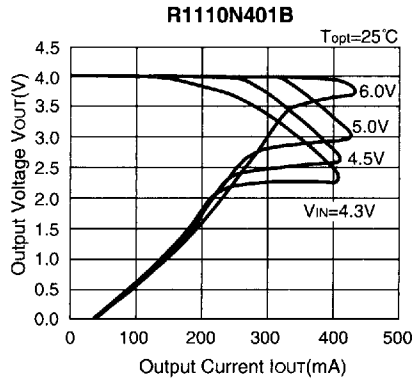
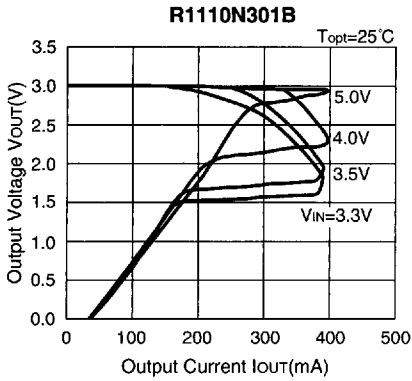

2) Output Voltage vs. Input Voltage

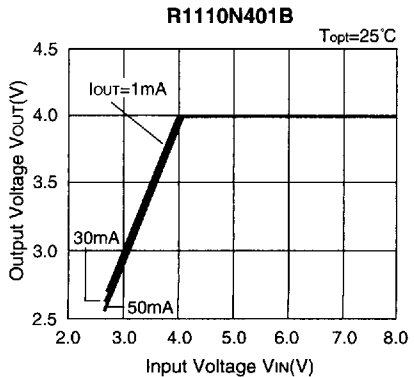
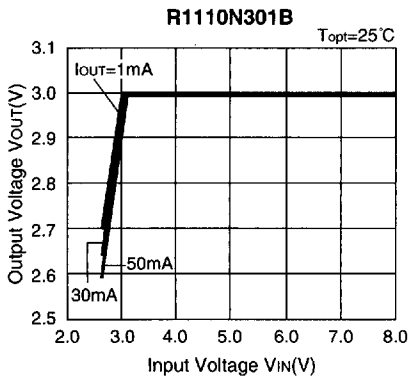

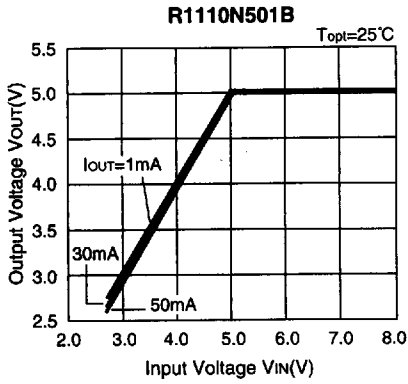

3) Dropout Voltage vs. Output Current

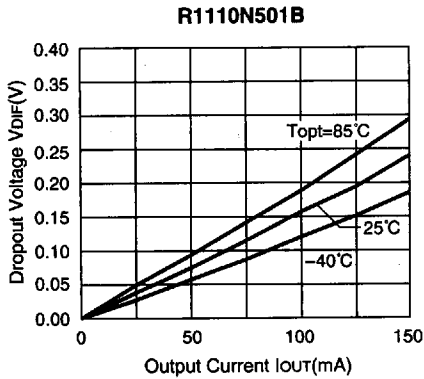
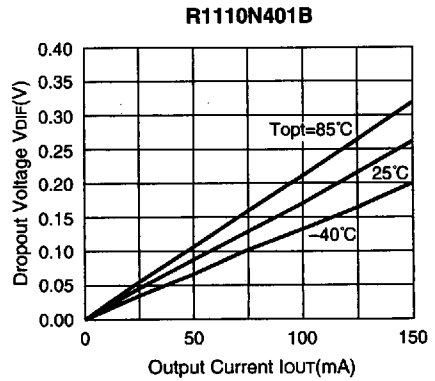
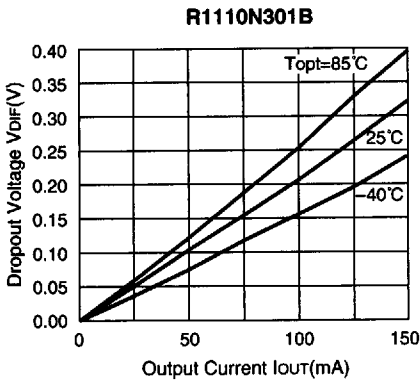

4) Output Voltage vs. Temperature

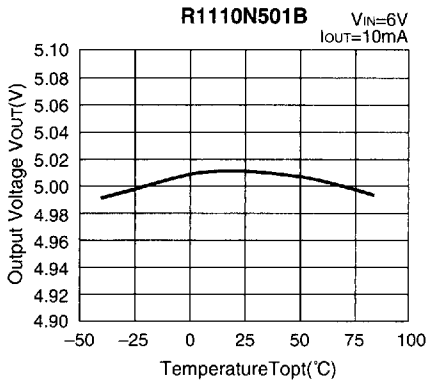
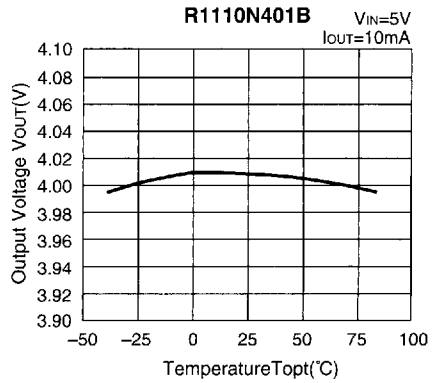
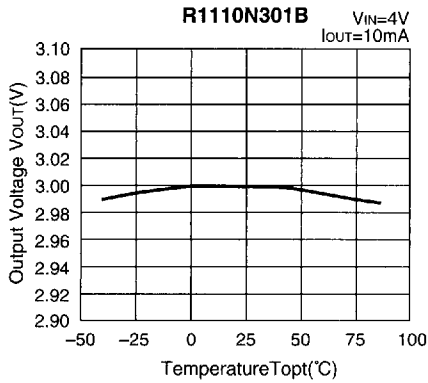

5) Supply Current vs. Input Voltage

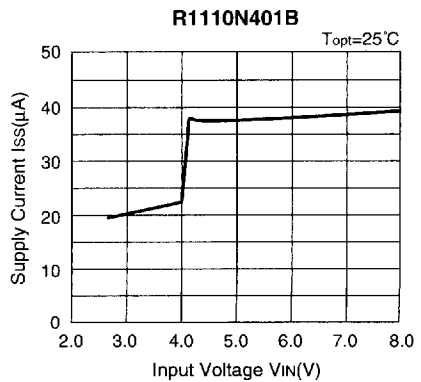
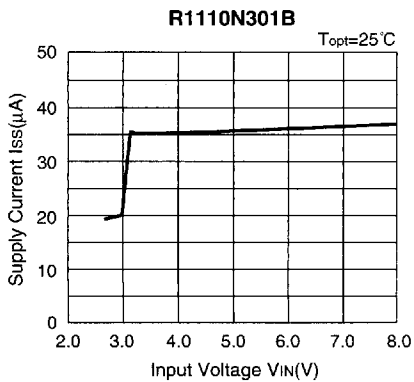

7744690 0004032 974

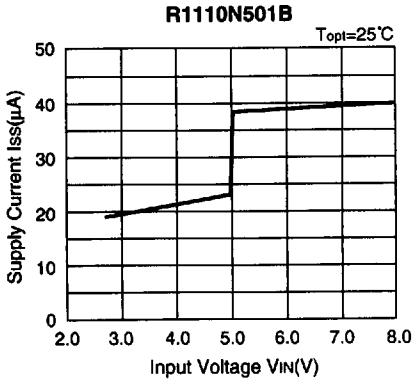

6) Supply Current vs. Temperature

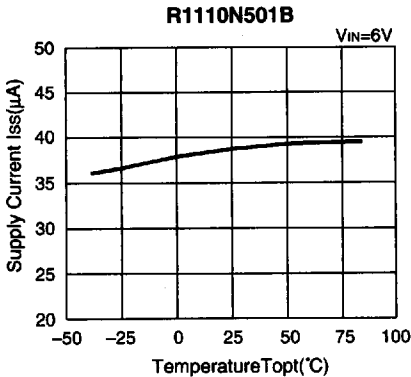
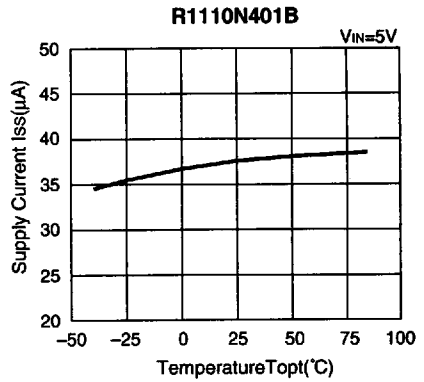
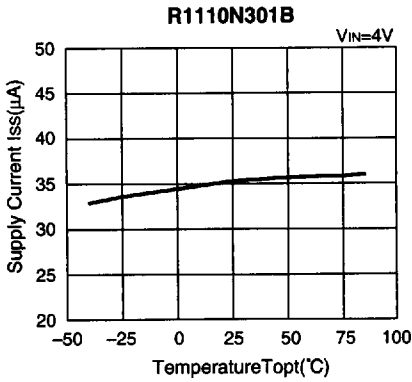

7) Dropout Voltage vs. Set Output Voltage

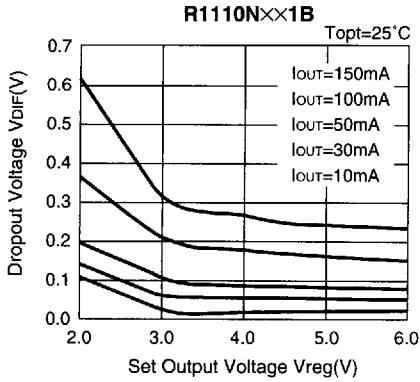

8) Ripple Rejection vs. Frequency

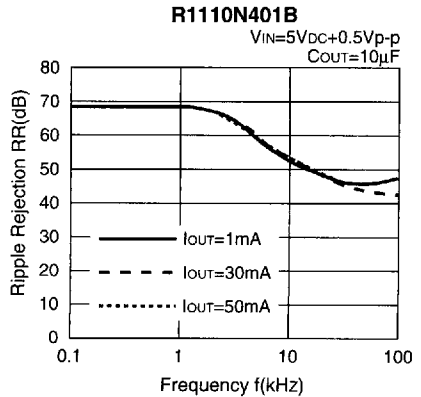
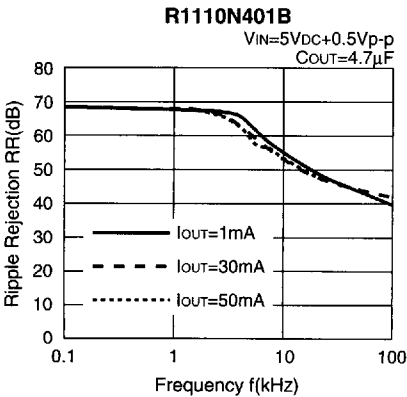
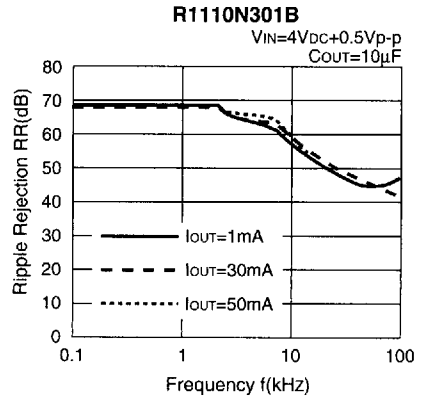
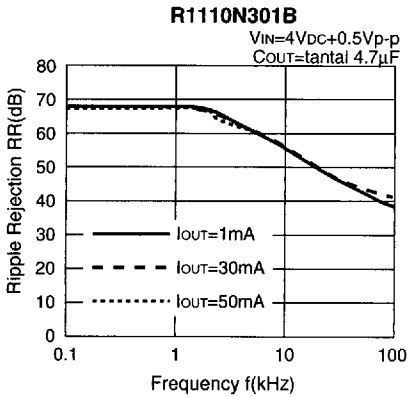

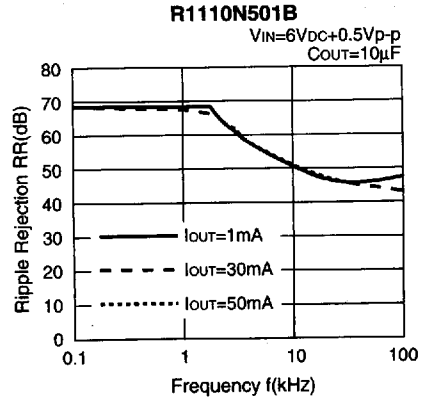
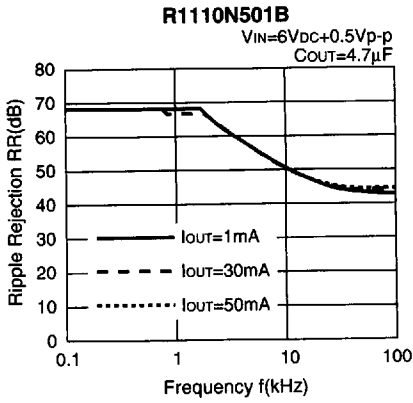

9) Ripple Rejection vs. Input Voltage (DC bias)

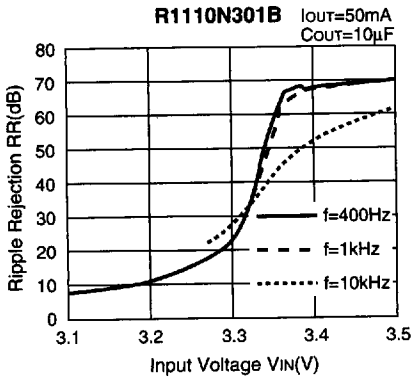
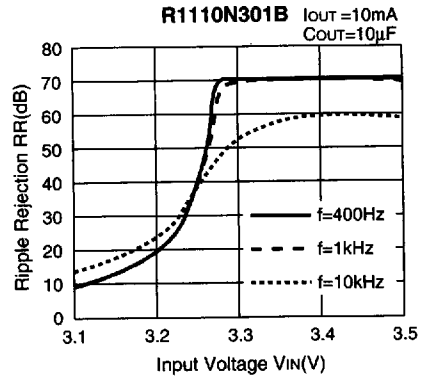
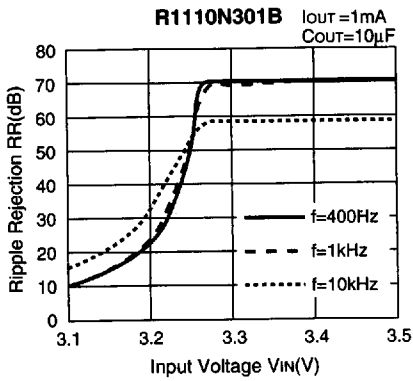

10) Line Transient Response

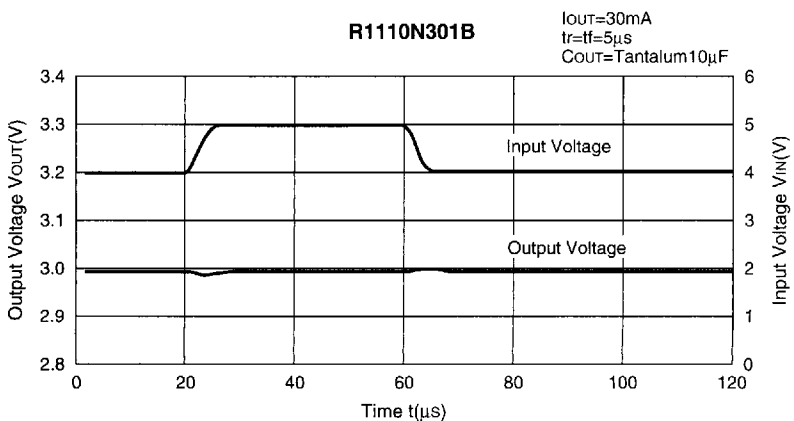
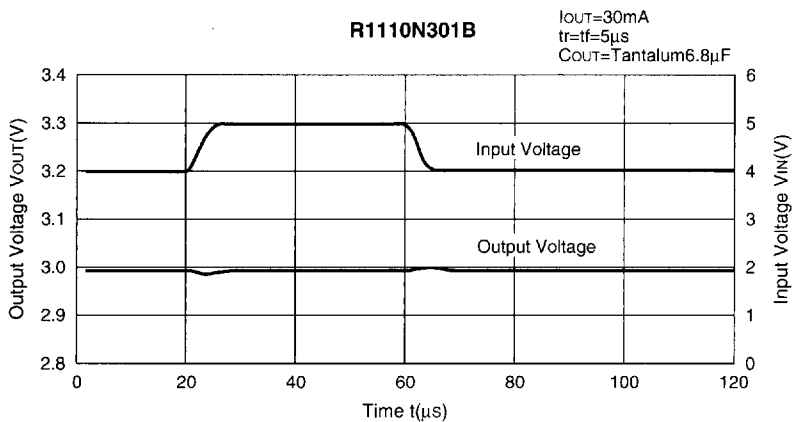
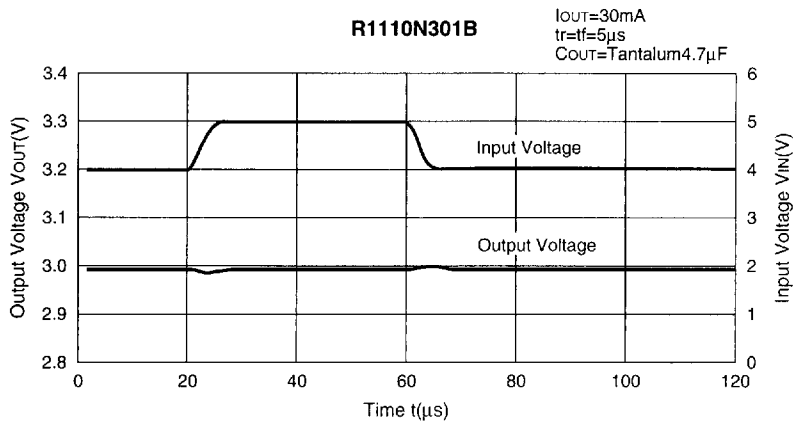

7744690 0004036 51T

RIGOH

11) Load Transient Response

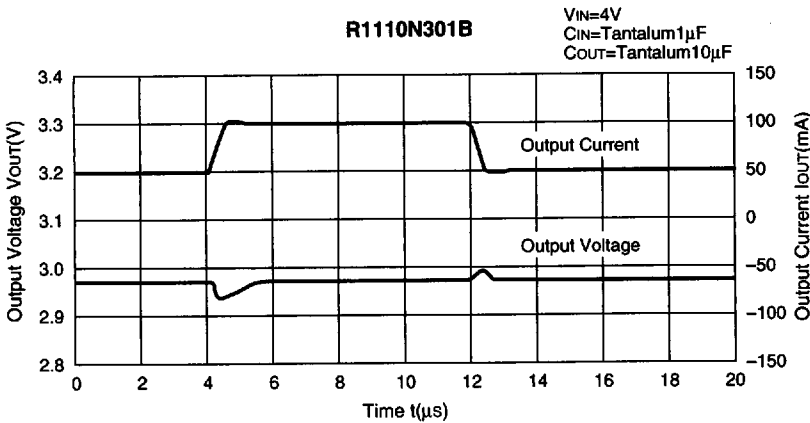
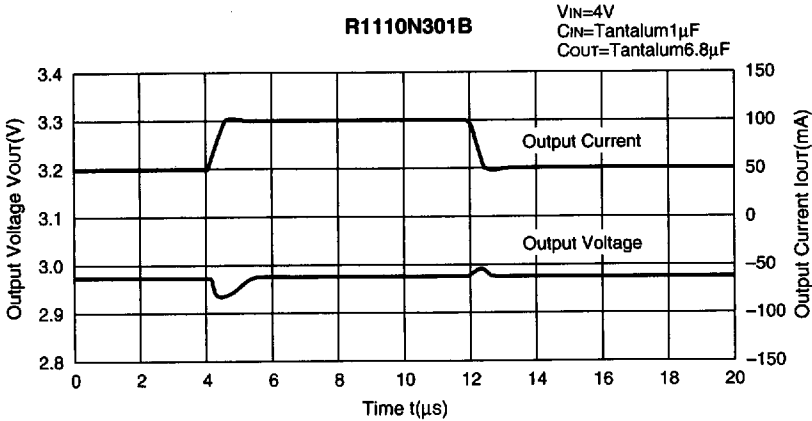
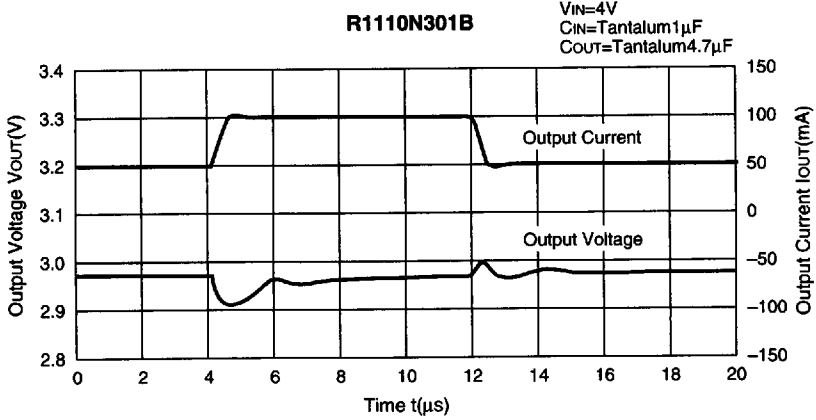

APPLICATION HINTS

When using these ICs, be sure to take care of following points :

- In these ICs, phase compensation is made for securing stable operation even if the load current is varied. For this purpose, be sure to use a capacitor C_{OUT} with good frequency characteristics and ESR (Equivalent Series Resistance) of which is in the range described as follows :

The relations between I_{OUT} (Output Current) and ESR of Output Capacitor are shown below. The conditions when the white noise level is under $40\mu V$ (Avg.) are marked as the hatched area in the graph. (note : When the additional ceramic capacitors are connected to the Output Pin with Output capacitor for phase compensation, there are possibilities that the operation will be unstable. Because of this, test these ICs with as same external components as ones to be used on the PCB.)

< measuring conditions >

$$V_{IN}=4V$$

Frequency band : 10Hz to 1MHz

Temperature : 25°C

- Make V_{DD} and GND line sufficient. When the impedance of these is high, there is a case to pick up the noise or not to work correctly.
- Connect the capacitor with a capacitance of $1\mu F$ or more between V_{DD} and GND as close as possible.
- Set external components, especially Output Capacitor, as close as possible to the ICs and make wiring shortest.

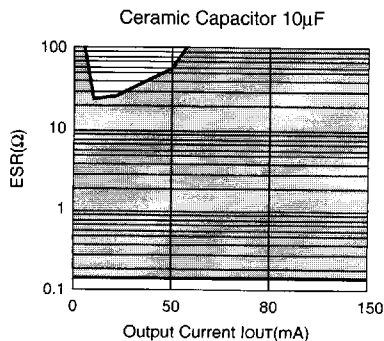
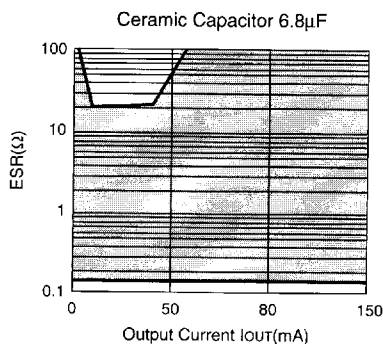
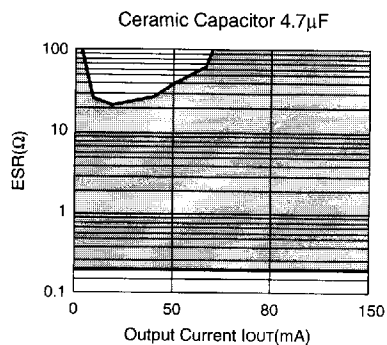

• Measuring Circuit for white noise ; R1110N301B

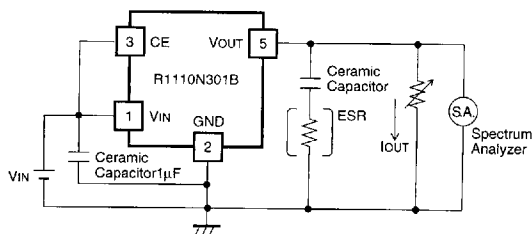

7744690 0004038 392

RICOH

TYPICAL APPLICATION

