

UTC MC34074 LINEAR INTEGRATED CIRCUIT

HIGH SLEW RATE, WIDE BANDWIDTH, SINGLE SUPPLY OPERATIONAL AMPLIFIER

DESCRIPTION

The UTC MC34074 offer 4.5MHz of gain bandwidth product, 13V/ μ s slew rate and fast setting time without the use of JFET device technology. Although it can be operated from split supplies, it is particularly suited for single supply operation, since the common mode input voltage range includes ground potential (V_{EE}). With A Darlington input stage, it exhibits high input resistance, low input offset voltage and high gain. The all NPN output stage, characterized by no deadband crossover distortion and large output voltage swing, provides high capacitance drive capability, excellent phase and gain margins, low open loop high frequency output impedance and symmetrical source/sink AC frequency response.

FEATURES

- *Wide bandwidth: 4.5 MHz
- *High slew rate: 13V/ μ s
- *Fast settling time: 1.1 μ s to 0.1%
- *Wide single supply operation: 3.0V to 44V
- *Wide input common mode voltage range:
Includes Ground (V_{EE})
- *Low input offset voltage: 3.0mV maximum
- *Large output voltage swing: -14.7V to +14V
(with \pm 15V supplies)
- *Large Capacitance Drive Capability: 0pF to 10,000 pF
- *Low total harmonic distortion: 0.02%
- *Excellent phase margin: 60°
- *Excellent gain margin: 12dB
- *Output short circuit protection
- *ESD Diodes/Clamps provide input protection

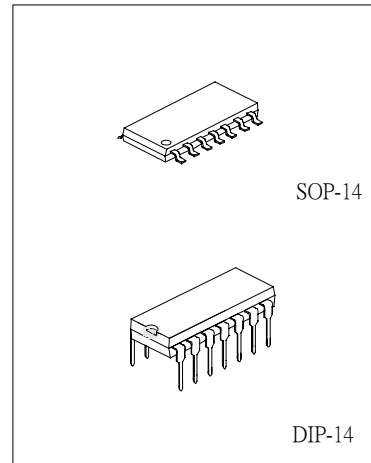

PIN CONFIGURATIONS

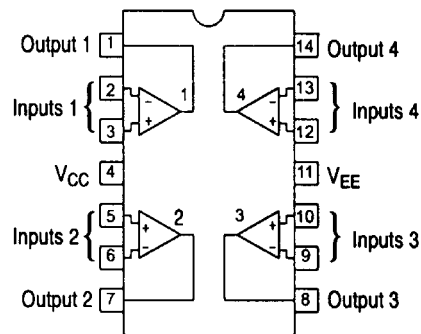

UTC MC34074 LINEAR INTEGRATED CIRCUIT

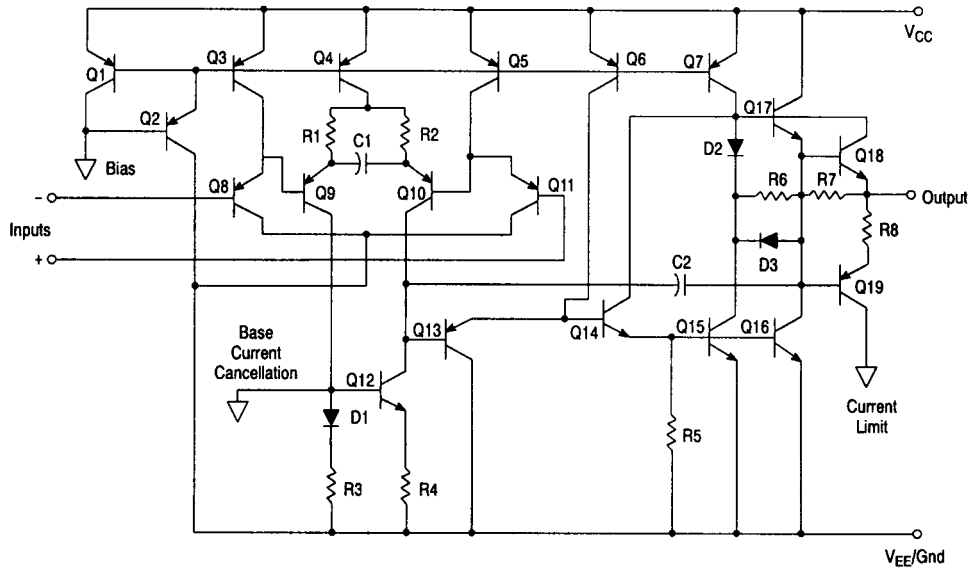

Figure 2. Representative Schematic Diagram

ABSOLUTE MAXIMUM RATINGS (Ta=25°C)

PARAMETER	SYMBOL	VALUE	UNIT
Supply Voltage (from V _{EE} to V _{CC})	V _s	+44	V
Differential Input Voltage	V _{IDR}	Note 1	V
Input Voltage	V _{IR}	Note 1	V
Output Short Circuit Duration (Note 2)	t _{SC}	Indefinite	sec
Operating Junction Temperature	T _J	+150	°C
Storage Temperature Range	T _{stg}	-60 to +150	°C

Notes: 1. Either or both input voltages should not exceed the magnitude of V_{CC} or V_{EE}.
 2. Power dissipation must be considered to ensure maximum junction temperature (T_J) is not exceeded. (see Figure 2)

UTC MC34074 LINEAR INTEGRATED CIRCUIT

ELECTRICAL CHARACTERISTICS ($V_{CC}=+15V$, $V_{EE}=-15V$, R_L =connected to ground, unless otherwise noted)

PARAMETER	SYMBOL	TEST CONDITIONS	MIN	TYP	MAX	UNIT
Input Offset Voltage	V_{IO}	$R_S=100\Omega$, $V_{CM}=0V$, $V_O=0V$, $V_{CC}=+15V$, $V_{EE}=-15V$, $T_A=+25^\circ C$		0.5	3.0	mV
		$V_{CC}=+5V$, $V_{EE}=0V$, $T_A=+25^\circ C$		0.5	3.0	mV
		$V_{CC}=+15V$, $V_{EE}=-15V$, $T_A=0^\circ C$ to $70^\circ C$				5.0
Average Temperature Coefficient of Input Offset Voltage	$\Delta V_{IO}/\Delta T$	$R_S=10\Omega$, $V_{CM}=0V$, $V_O=0V$, $T_A=0^\circ C$ to $70^\circ C$		10		$\mu V/^\circ C$
Input Bias Current	I_{IB}	$V_{CM}=0V$, $V_O=0V$, $T_A=+25^\circ C$, $T_A=0^\circ C$ to $70^\circ C$		100	500 700	nA
Input Offset Current	I_{IO}	$V_{CM}=0V$, $V_O=0V$, $T_A=+25^\circ C$, $T_A=0^\circ C$ to $70^\circ C$		6.0	50 300	nA
Input Common Mode Voltage	V_{ICR}	$T_A=+25^\circ C$		V_{EE} to $(V_{CC}-1.8)$		V
		$T_A=0^\circ C$ to $70^\circ C$		V_{EE} to $(V_{CC}-2.2)$		V
Large Signal Voltage Gain	A_{VOL}	$V_O=\pm 10V$, $R_L=2.0k\Omega$, $T_A=+25^\circ C$, $T_A=0^\circ C$ to $70^\circ C$	50 25	100		V/mV
Output Voltage Swing ($V_{ID}=\pm 1.0V$)	V_{OH}	$V_{CC}=+5.0V$, $V_{EE}=0V$, $R_L=2.0k\Omega$, $T_A=+25^\circ C$	3.7	4.0		V
		$V_{CC}=+15.0V$, $V_{EE}=-15V$, $R_L=10k\Omega$, $T_A=+25^\circ C$	13.6	14		V
		$V_{CC}=+15.0V$, $V_{EE}=-15V$, $R_L=2.0k\Omega$, $T_A=0^\circ C$ to $70^\circ C$	13.4			V
Output Voltage Swing ($V_{ID}=\pm 1.0V$)	V_{OL}	$V_{CC}=+5.0V$, $V_{EE}=0V$, $R_L=2.0k\Omega$, $T_A=+25^\circ C$		0.1	0.3	V
		$V_{CC}=+15.0V$, $V_{EE}=-15V$, $R_L=10k\Omega$, $T_A=+25^\circ C$		-14.7	-14.3	V
		$V_{CC}=+15.0V$, $V_{EE}=-15V$, $R_L=2.0k\Omega$, $T_A=0^\circ C$ to $70^\circ C$			-13.5	V
Output Short Circuit current	I_{SC}	$V_{ID}=1.0V$, $V_O=0V$, $T_A=25^\circ C$ Source Sink	10 20	30 30		mA
Common Mode Rejection	CMR	$R_S \leq 10k\Omega$, $V_{CM}=V_{ICR}$, $T_A=25^\circ C$	80	97		dB
Power Supply Rejection ($R_S=100\Omega$)	PSR	$V_{CC}/V_{EE}=\pm 16.5V/-16.5V$ to $\pm 13.5V/-13.5V$, $T_A=25^\circ C$	80	97		dB
Power Supply Current (Per Amplifier, No Load)	I_D	$V_{CC}=+5.0V$, $V_{EE}=0V$, $V_O=+2.5V$, $T_A=+25^\circ C$		1.6	2.0	mA
		$V_{CC}=+15.0V$, $V_{EE}=-15V$, $V_O=0V$, $T_A=+25^\circ C$		1.9	2.5	mA
		$V_{CC}=+15.0V$, $V_{EE}=-15V$, $V_O=0V$, $T_A=0^\circ C$ to $70^\circ C$			2.8	mA
Slew Rate	SR	$V_{in}=-10V$ to $+10V$, $R_L=2.0k\Omega$, $C_L=500pF$, $A_v=+1.0$	8.0	10		V/ μs
		$A_v=-1.0$		13		
Setting Time	t_s	10 Setp, $A_v=-1.0$ to 0.1% (+1/2 LSB of 9-Bits) to 0.01% (+1/2 LSB of 12-Bits)		1.1 2.2		μs
Gain Bandwidth Product	GBW	$f=100kHz$	3.5	4.5		MHz
Power Bandwidth	BW	$A_v=+1.0$, $R_L=2k\Omega$, $V_O=20V_{pp}$, THD=5.0%		160		kHz

UTC MC34074 LINEAR INTEGRATED CIRCUIT

PARAMETER	SYMBOL	TEST CONDITIONS	MIN	TYP	MAX	UNIT
Phase Margin	fm	$R_L=2k\Omega$ $R_L=2k\Omega, C_L=300pF$		60 40		Deg
Gain Margin	Am	$R_L=2k\Omega$ $R_L=2k\Omega, C_L=300pF$		12 4		dB
Equivalent Input Noise Voltage	en	$R_S=100\Omega, f=1.0kHz$		32		nV/\sqrt{Hz}
Equivalent Input Noise Current	in	$f=1.0kHz$		0.22		pA/\sqrt{Hz}
Differential Input Resistance	Rin	$V_{CM}=0V$		150		$M\Omega$
Differential Input Capacitance	Cin	$V_{CM}=0V$		2.5		pF
Total Harmonic distortion	THD	$A_v=+10, R_L=2.0kHz,$ $2.0V_{pp}\leq V_o\leq 20V_{pp}, f=10kHz$		0.02		%
Channel Separation		$f=10kHz$		120		dB
Open Loop Output Impedance	IZol	$f=1.0MHz$		30		W

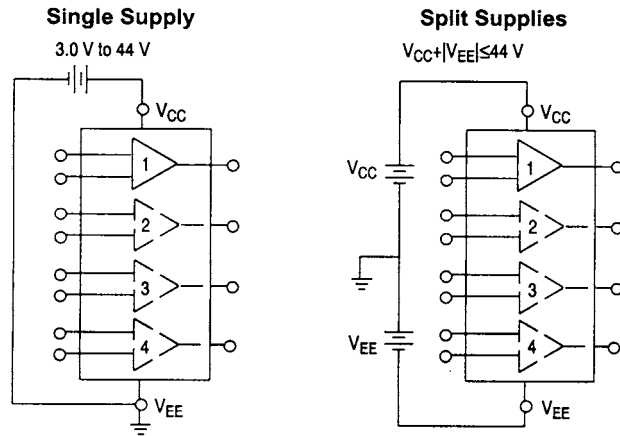

Figure 3. Power Supply Configurations

UTC MC34074 LINEAR INTEGRATED CIRCUIT

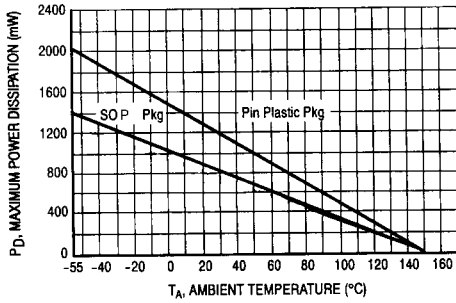

Figure 4. Maximum Power Dissipation versus Temperature for Package Types

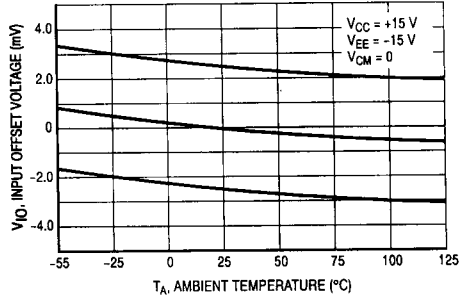

Figure 5. Input Offset Voltage versus Temperature for Representative Units

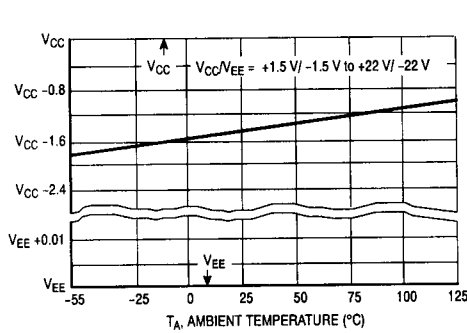

Figure 6. Input Common Mode Voltage Range versus Temperature

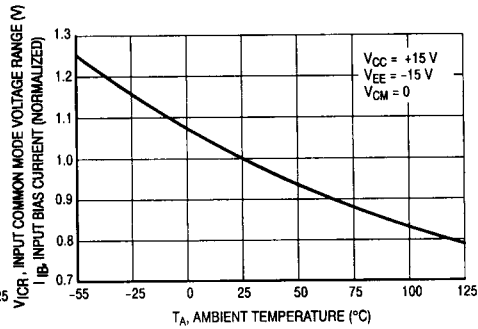

Figure 7. Normalized Input Bias Current versus Temperature

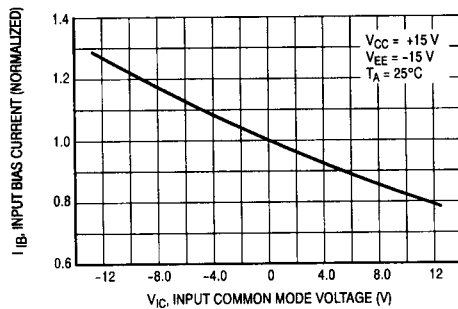

Figure 8. Normalized Input Bias Current versus Input Common Mode Voltage

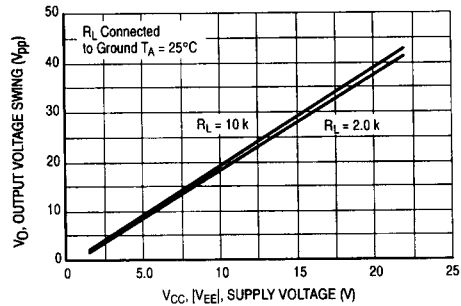

Figure 9. Split Supply Output Voltage Swing versus Supply Voltage

UTC MC34074 LINEAR INTEGRATED CIRCUIT

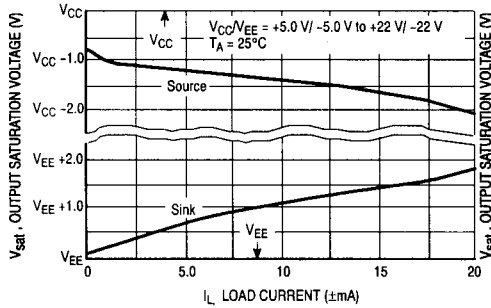

Figure 10. Single Supply Output Saturation versus Load Current

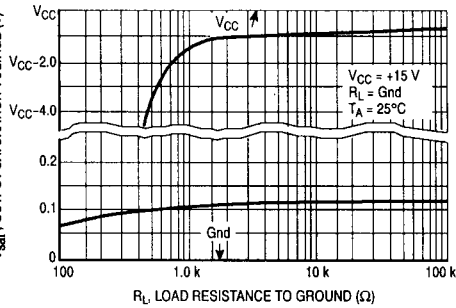

Figure 11. Split Supply Output Saturation versus Load Current

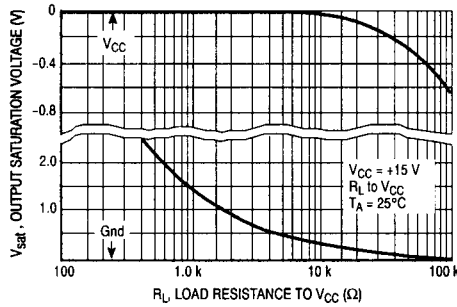

Figure 12. Single Supply Output Saturation versus Load Resistance to Ground

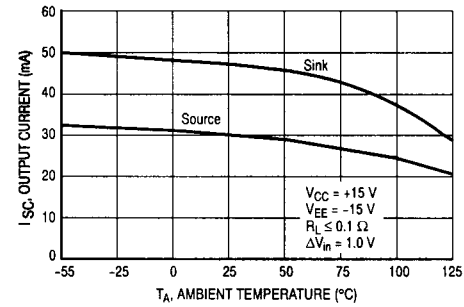

Figure 13. Output Short Circuit Current versus Temperature

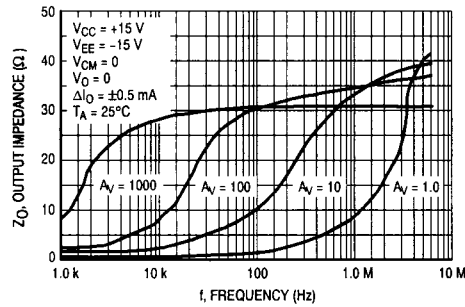

Figure 14. Output Impedance versus Frequency

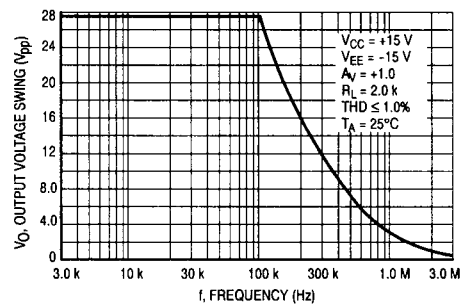

Figure 15. Output Voltage Swing versus Frequency

UTC MC34074 LINEAR INTEGRATED CIRCUIT

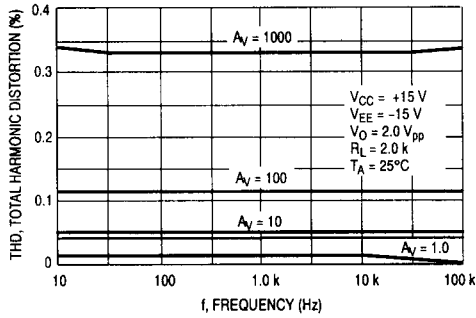

Figure 16. Total Harmonic Distortion versus Frequency

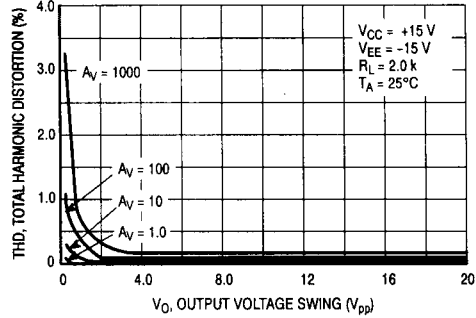

Figure 17. Total Harmonic Distortion versus Output Voltage Swing

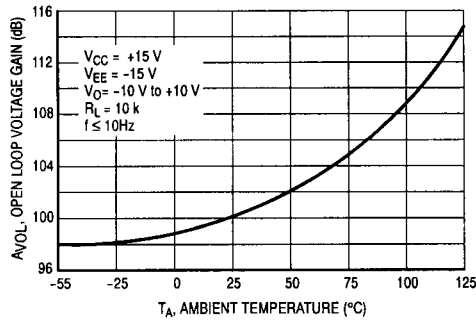

Figure 18. Open Loop Voltage Gain versus Temperature

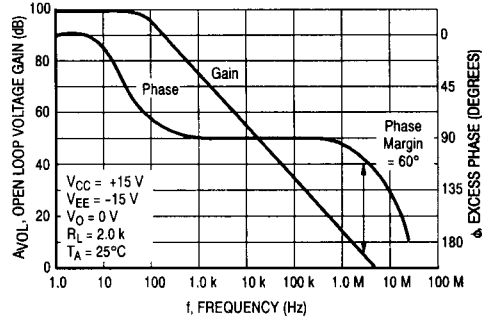

Figure 19. Open Loop Voltage Gain and Phase versus Frequency

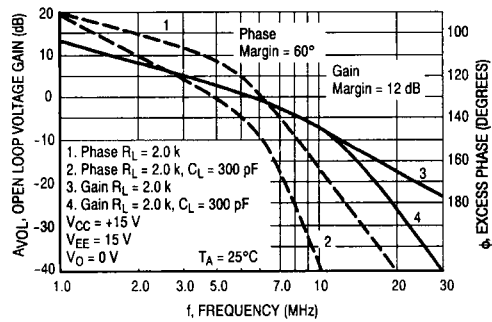

Figure 20. Open Loop Voltage Gain and Phase versus Frequency

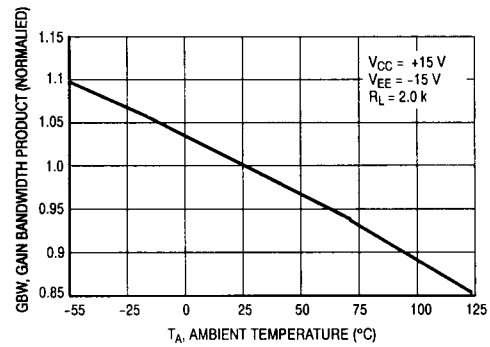

Figure 21. Normalized Gain Bandwidth Product versus Temperature

UTC MC34074 LINEAR INTEGRATED CIRCUIT

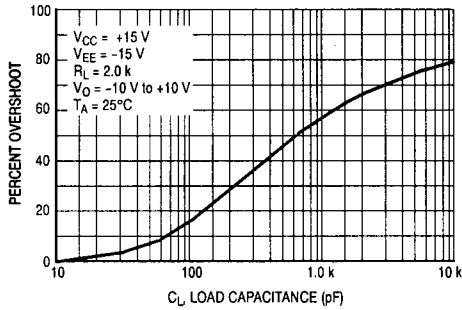

Figure 22. Percent Overshoot versus Load Capacitance

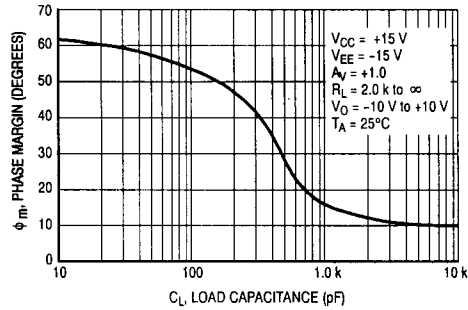

Figure 23. Phase Margin versus Load Capacitance

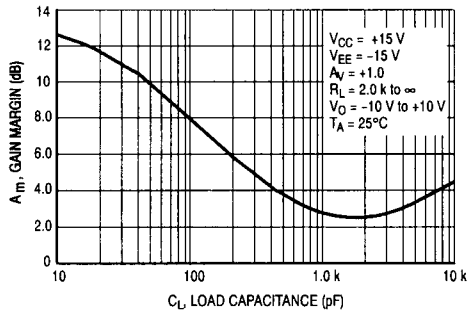

Figure 24. Gain Margin versus Load Capacitance

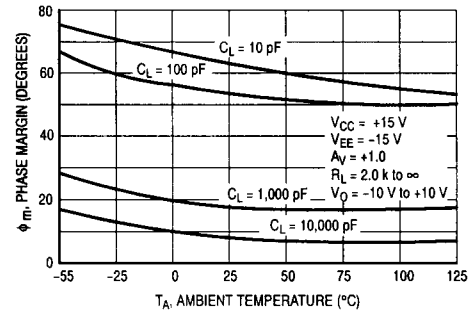

Figure 25. Phase Margin versus Temperature

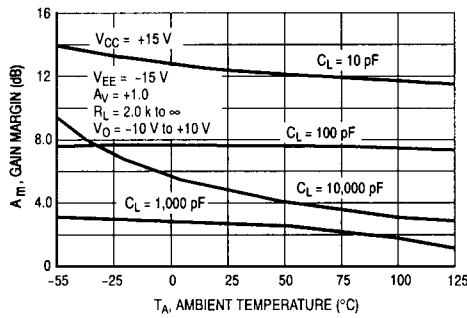

Figure 26. Gain Margin versus Temperature

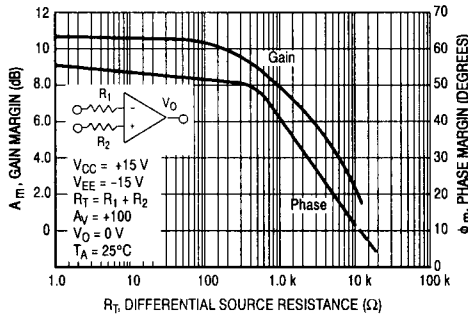

Figure 27. Phase Margin and Gain Margin versus Differential Source Resistance

UTC MC34074 LINEAR INTEGRATED CIRCUIT

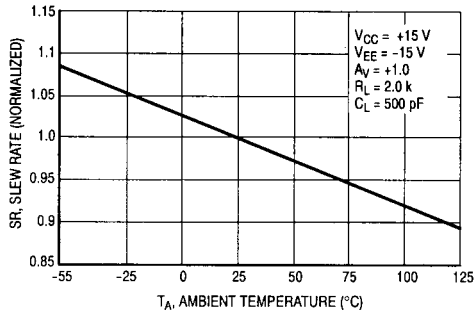

Figure 28. Normalized Slew Rate versus Temperature

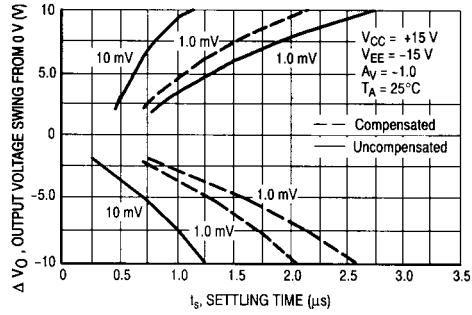

Figure 29. Output Settling Time

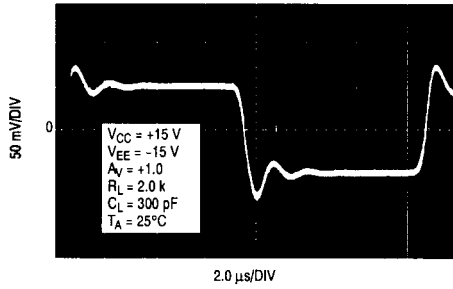

Figure 30. Small Signal Transient Response

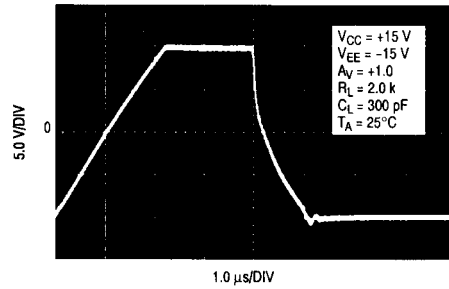

Figure 31. Large Signal Transient Response

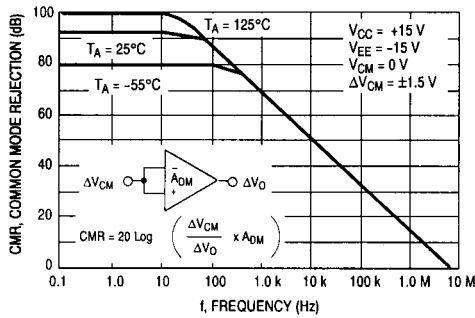

Figure 32. Common Mode Rejection versus Frequency

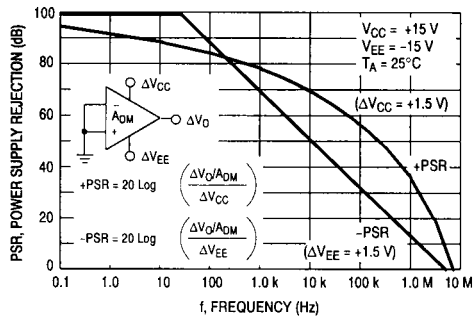

Figure 33. Power Supply Rejection versus Frequency

UTC MC34074 LINEAR INTEGRATED CIRCUIT

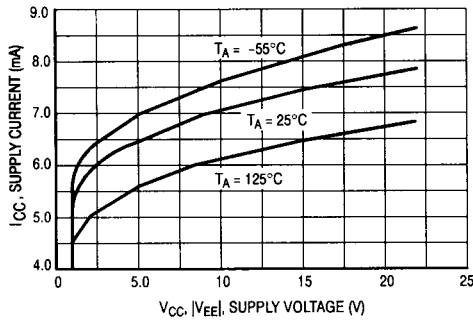

Figure 34. Supply Current versus Supply Voltage

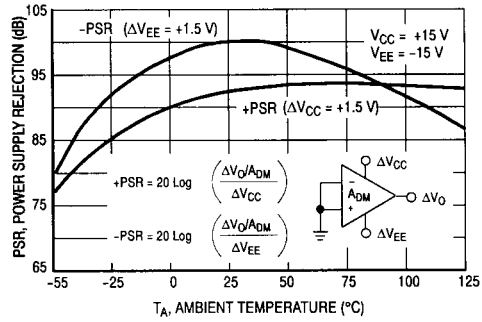

Figure 35. Power Supply Rejection versus Temperature

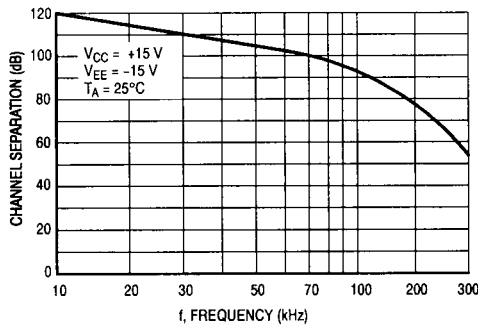

Figure 36. Channel Separation versus Frequency

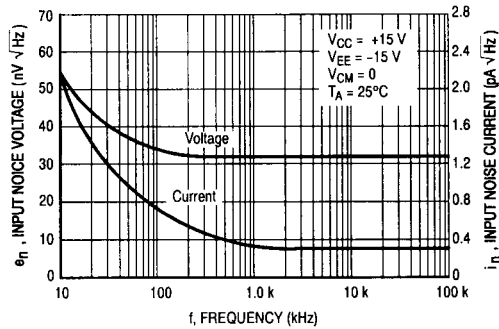

Figure 37. Input Noise versus Frequency

UTC assumes no responsibility for equipment failures that result from using products at values that exceed, even momentarily, rated values (such as maximum ratings, operating condition ranges, or other parameters) listed in products specifications of any and all UTC products described or contained herein. UTC products are not designed for use in life support appliances, devices or systems where malfunction of these products can be reasonably expected to result in personal injury. Reproduction in whole or in part is prohibited without the prior written consent of the copyright owner. The information presented in this document does not form part of any quotation or contract, is believed to be accurate and reliable and may be changed without notice.