

---

Document Title

512Kx36 & 1Mx18-Bit Pipelined NtRAM™

Revision History

<u>Rev.No.</u>	<u>History</u>	<u>Draft Date</u>	<u>Remark</u>
0.0	1. Initial document.	Dec. 22. 1998	Preliminary
0.1	1. Update ICC & ISB values.	May. 27. 1999	Preliminary
0.2	1. Change pin allocation at 119BGA . - A4 ; from NC to A . - B2 ; from A to CS2 - B4 ; from CKE to ADV - B6 ; from A to CS2 - G4 ; from ADV to A - H4 ; from NC to WE - M4 ; from WE toCKE 2. Changed DC condition at Icc and parameters Icc ; from 320mA to 300mA at -67, from 300mA to 280mA at -75,	Nov. 19. 1999	Preliminary
0.3	Add tCYC 167MHz.	Nov. 26. 1999	Preliminary
1.0	Finl spec release	Jan. 28. 2000	Final

---

The attached data sheets are prepared and approved by SAMSUNG Electronics. SAMSUNG Electronics CO., LTD. reserve the right to change the specifications. SAMSUNG Electronics will evaluate and reply to your requests and questions on the parameters of this device. If you have any questions, please contact the SAMSUNG branch office near your office, call or contact Headquarters.

---

**512Kx36 & 1Mx18-Bit Pipelined NtRAM™**

**FEATURES**

- 2.5V ±5% Power Supply.
- Byte Writable Function.
- Enable clock and suspend operation.
- Single READ/WRITE control pin.
- Self-Timed Write Cycle.
- Three Chip Enable for simple depth expansion with no data-contention .
- A interleaved burst or a linear burst mode.
- Asynchronous output enable control.
- Power Down mode.
- 100-TQFP-1420A /119BGA(7x17 Ball Grid Array Package).

**GENERAL DESCRIPTION**

The KM736S949 and KM718S049 are 18,874,368-bits Synchronous Static SRAMs.

The NtRAM™, or No Turnaround Random Access Memory utilizes all the bandwidth in any combination of operating cycles. Address, data inputs, and all control signals except output enable and linear burst order are synchronized to input clock. Burst order control must be tied "High or Low". Asynchronous inputs include the sleep mode enable(ZZ). Output Enable controls the outputs at any given time. Write cycles are internally self-timed and initiated by the rising edge of the clock input. This feature eliminates complex off-chip write pulse generation and provides increased timing flexibility for incoming signals. For read cycles, pipelined SRAM output data is temporarily stored by an edge triggered output register and then released to the output buffers at the next rising edge of clock.

The KM736S949 and KM718S049 are implemented with SAMSUNG's high performance CMOS technology and is available in 100pin TQFP and 119BGA packages. Multiple power and ground pins minimize ground bounce.

**FAST ACCESS TIMES**

PARAMETER	Symbol	-60	-67	-75	-10	Unit
Cycle Time	t <sub>CYC</sub>	6.0	6.7	7.5	10	ns
Clock Access Time	t <sub>CD</sub>	3.5	3.8	4.2	5.0	ns
Output Enable Access Time	t <sub>OE</sub>	3.5	3.8	4.2	5.0	ns

**LOGIC BLOCK DIAGRAM**

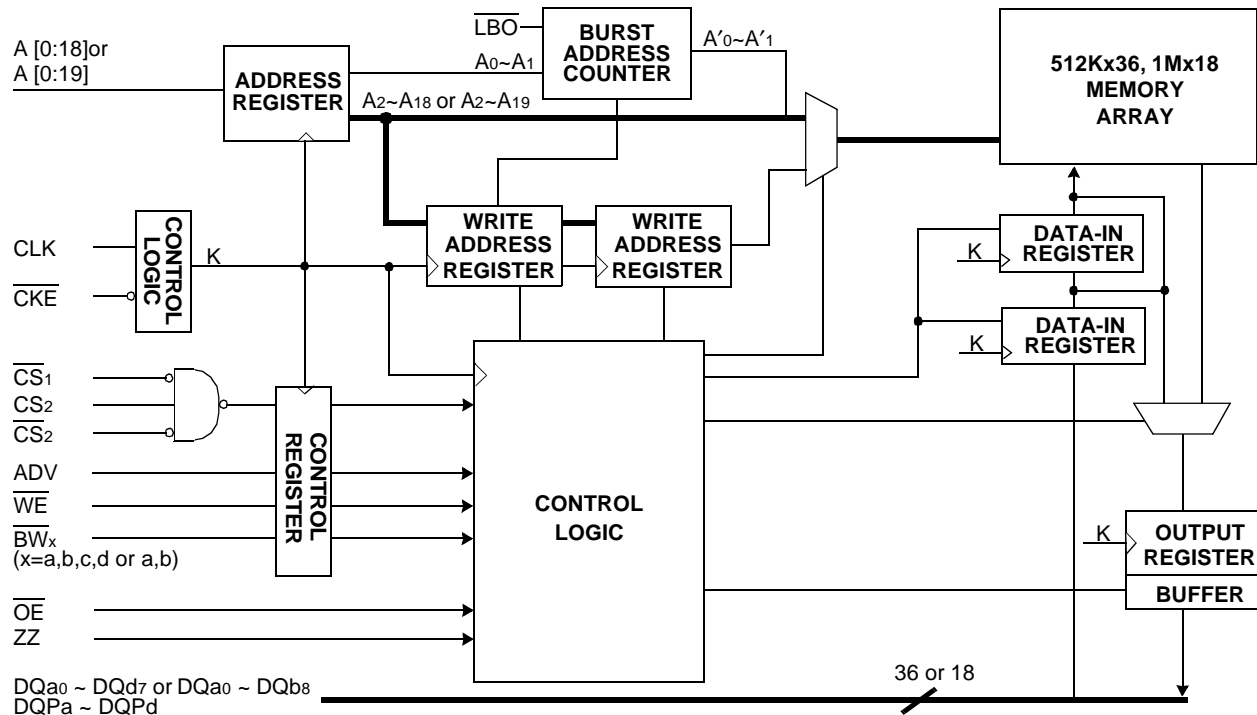

**PIN CONFIGURATION(TOP VIEW)**

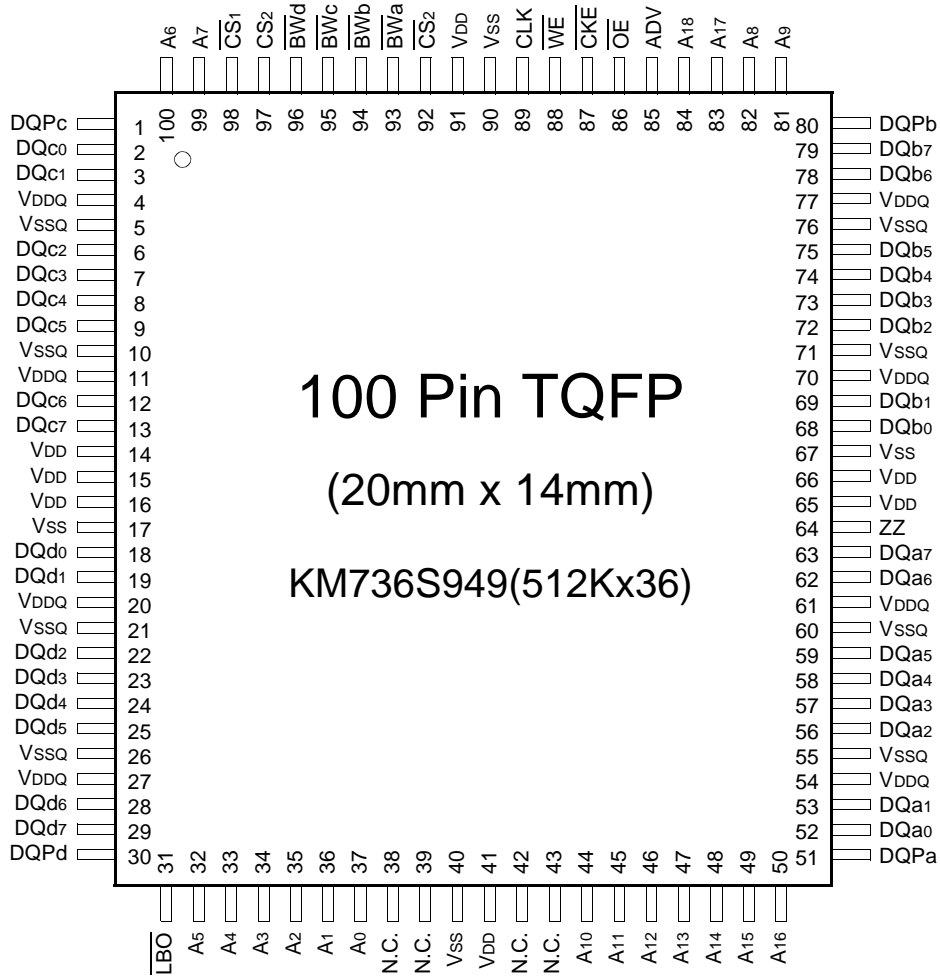

**PIN NAME**

SYMBOL	PIN NAME	TQFP PIN NO.	SYMBOL	PIN NAME	TQFP PIN NO.
A <sub>0</sub> - A <sub>18</sub>	Address Inputs	32,33,34,35,36,37,44 45,46,47,48,49,50,81 82,83,84,99,100	VDD	Power Supply(2.5V)	14,15,16,41,65,66,91
			VSS	Ground	17,40,67,90
ADV	Address Advance/Load	85	N.C.	No Connect	38,39,42,43
WE	Read/Write Control Input	88	DQa <sub>0</sub> ~a <sub>7</sub>	Data Inputs/Outputs	52,53,56,57,58,59,62,63
CLK	Clock	89	DQb <sub>0</sub> ~b <sub>7</sub>	Data Inputs/Outputs	68,69,72,73,74,75,78,79
CKE	Clock Enable	87	DQc <sub>0</sub> ~c <sub>7</sub>	Data Inputs/Outputs	2,3,6,7,8,9,12,13
CS <sub>1</sub>	Chip Select	98	DQd <sub>0</sub> ~d <sub>7</sub>	Data Inputs/Outputs	18,19,22,23,24,25,28,29
CS <sub>2</sub>	Chip Select	97	DQPa~Pd	Data Inputs/Outputs	51,80,1,30
CS <sub>2</sub>	Chip Select	92			
BW <sub>x</sub> (x=a,b,c,d)	Byte Write Inputs	93,94,95,96	VDDQ	Output Power Supply (2.5V)	4,11,20,27,54,61,70,77
OE	Output Enable	86	VSSQ	Output Ground	5,10,21,26,55,60,71,76
ZZ	Power Sleep Mode	64			
LBO	Burst Mode Control	31			

**Note :** 1. A<sub>0</sub> and A<sub>1</sub> are the two least significant bits(LSB) of the address field and set the internal burst counter if burst is desired.

**PIN CONFIGURATION(TOP VIEW)**

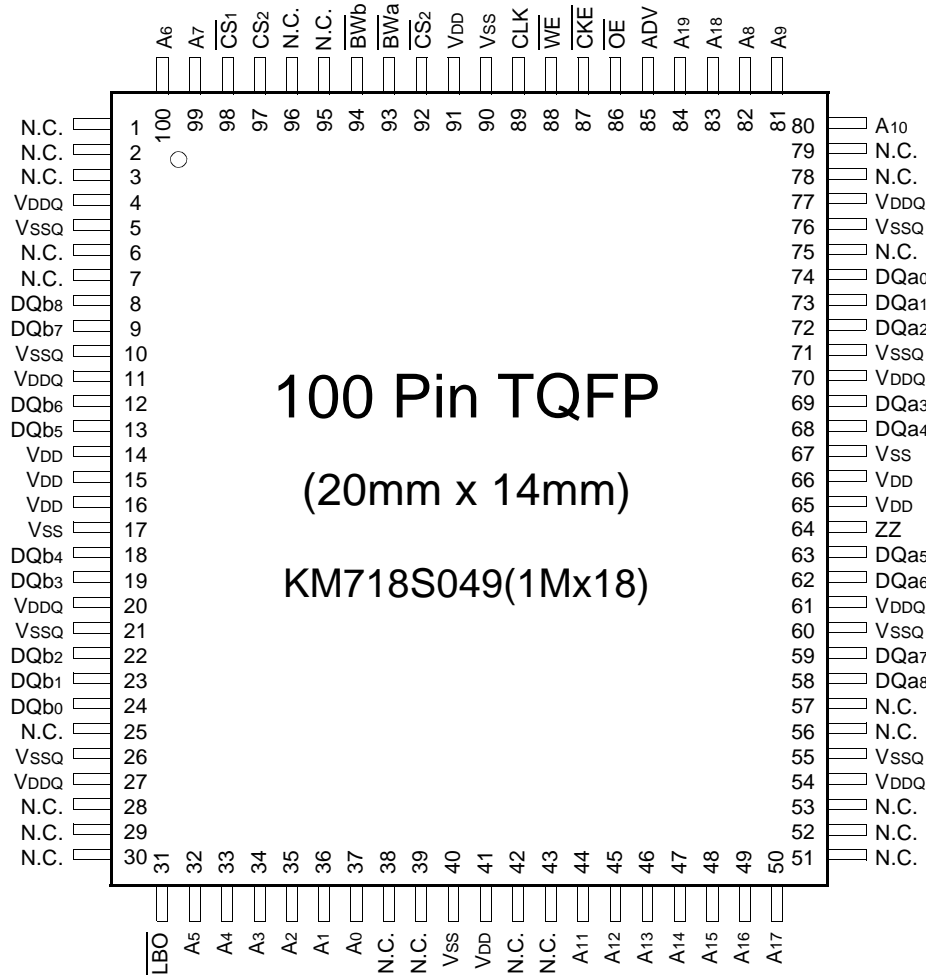

**PIN NAME**

SYMBOL	PIN NAME	TQFP PIN NO.	SYMBOL	PIN NAME	TQFP PIN NO.
A0 - A19	Address Inputs	32,33,34,35,36,37,44 45,46,47,48,49,50,80 81,82,83,84,99,100	VDD	Power Supply(2.5V)	14,15,16,41,65,66,91
			VSS	Ground	17,40,67,90
ADV	Address Advance/Load	85	N.C.	No Connect	1,2,3,6,7,25,28,29,30, 38,39,42,43,51,52,53, 56,57,75,78,79,95,96
WE	Read/Write Control Input	88			
CLK	Clock	89			
CKE	Clock Enable	87			
CS1	Chip Select	98	DQa0~a8	Data Inputs/Outputs	58,59,62,63,68,69,72,73,74
CS2	Chip Select	97	DQb0~b8	Data Inputs/Outputs	8,9,12,13,18,19,22,23,24
CS2	Chip Select	92			
BWx(x=a,b)	Byte Write Inputs	93,94			
OE	Output Enable	86	VDDQ	Output Power Supply (2.5V)	4,11,20,27,54,61,70,77
ZZ	Power Sleep Mode	64			
LBO	Burst Mode Control	31	VSSQ	Output Ground	5,10,21,26,55,60,71,76

**NOTE :** A0 and A1 are the two least significant bits(LSB) of the address field and set the internal burst counter if burst is desired.

**119BGA PACKAGE PIN CONFIGURATIONS(TOP VIEW)**

**KM736S949(512Kx36)**

	1	2	3	4	5	6	7
<b>A</b>	V <sub>DDQ</sub>	A	A	A	A	A	V <sub>DDQ</sub>
<b>B</b>	NC	CS <sub>2</sub>	A	ADV	A	$\overline{CS}_2$	NC
<b>C</b>	NC	A	A	V <sub>DD</sub>	A	A	NC
<b>D</b>	DQ <sub>c</sub>	DQP <sub>c</sub>	V <sub>SS</sub>	NC	V <sub>SS</sub>	DQP <sub>b</sub>	DQ <sub>b</sub>
<b>E</b>	DQ <sub>c</sub>	DQ <sub>c</sub>	V <sub>SS</sub>	$\overline{CS}_1$	V <sub>SS</sub>	DQ <sub>b</sub>	DQ <sub>b</sub>
<b>F</b>	V <sub>DDQ</sub>	DQ <sub>c</sub>	V <sub>SS</sub>	$\overline{OE}$	V <sub>SS</sub>	DQ <sub>b</sub>	V <sub>DDQ</sub>
<b>G</b>	DQ <sub>c</sub>	DQ <sub>c</sub>	$\overline{BW}_c$	A	$\overline{BW}_b$	DQ <sub>b</sub>	DQ <sub>b</sub>
<b>H</b>	DQ <sub>c</sub>	DQ <sub>c</sub>	V <sub>SS</sub>	$\overline{WE}$	V <sub>SS</sub>	DQ <sub>b</sub>	DQ <sub>b</sub>
<b>J</b>	V <sub>DDQ</sub>	V <sub>DD</sub>	NC	V <sub>DD</sub>	NC	V <sub>DD</sub>	V <sub>DDQ</sub>
<b>K</b>	DQ <sub>d</sub>	DQ <sub>d</sub>	V <sub>SS</sub>	CLK	V <sub>SS</sub>	DQ <sub>a</sub>	DQ <sub>a</sub>
<b>L</b>	DQ <sub>d</sub>	DQ <sub>d</sub>	$\overline{BW}_d$	NC	$\overline{BW}_a$	DQ <sub>a</sub>	DQ <sub>a</sub>
<b>M</b>	V <sub>DDQ</sub>	DQ <sub>d</sub>	V <sub>SS</sub>	$\overline{CKE}$	V <sub>SS</sub>	DQ <sub>a</sub>	V <sub>DDQ</sub>
<b>N</b>	DQ <sub>d</sub>	DQ <sub>d</sub>	V <sub>SS</sub>	A <sub>1</sub> *	V <sub>SS</sub>	DQ <sub>a</sub>	DQ <sub>a</sub>
<b>P</b>	DQ <sub>d</sub>	DQP <sub>d</sub>	V <sub>SS</sub>	A <sub>0</sub> *	V <sub>SS</sub>	DQP <sub>a</sub>	DQ <sub>a</sub>
<b>R</b>	NC	A	$\overline{LBO}$	V <sub>DD</sub>	NC	A	NC
<b>T</b>	NC	NC	A	A	A	NC	ZZ
<b>U</b>	V <sub>DDQ</sub>	NC	NC	NC	NC	NC	V <sub>DDQ</sub>

**Note :** \* A<sub>0</sub> and A<sub>1</sub> are the two least significant bits(LSB) of the address field and set the internal burst counter if burst is desired.

**PIN NAME**

SYMBOL	PIN NAME	SYMBOL	PIN NAME
A	Address Inputs	V <sub>DD</sub>	Power Supply
A <sub>0</sub> ,A <sub>1</sub>	Burst Address Inputs	V <sub>SS</sub>	Ground
ADV	Address Advance/Load	N.C.	No Connect
$\overline{WE}$	Read/Write Control Input		
CLK	Clock	DQ <sub>a</sub>	Data Inputs/Outputs
$\overline{CKE}$	Clock Enable	DQ <sub>b</sub>	Data Inputs/Outputs
$\overline{CS}_1$	Chip Select	DQ <sub>c</sub>	Data Inputs/Outputs
CS <sub>2</sub>	Chip Select	DQ <sub>d</sub>	Data Inputs/Outputs
$\overline{CS}_2$	Chip Select	DQPa~Pd	Data Inputs/Outputs
$\overline{BW}_x$	Byte Write Inputs		
(x=a,b,c,d)		V <sub>DDQ</sub>	Output Power Supply
$\overline{OE}$	Output Enable		
ZZ	Power Sleep Mode		
LBO	Burst Mode Control		

**119BGA PACKAGE PIN CONFIGURATIONS(TOP VIEW)**

**KM718S049(1Mx18)**

	1	2	3	4	5	6	7
<b>A</b>	V <sub>DDQ</sub>	A	A	A	A	A	V <sub>DDQ</sub>
<b>B</b>	NC	CS <sub>2</sub>	A	ADV	A	$\overline{\text{CS}}_2$	NC
<b>C</b>	NC	A	A	V <sub>DD</sub>	A	A	NC
<b>D</b>	DQ <sub>b</sub>	NC	V <sub>SS</sub>	NC	V <sub>SS</sub>	DQP <sub>a</sub>	NC
<b>E</b>	NC	DQ <sub>b</sub>	V <sub>SS</sub>	$\overline{\text{CS}}_1$	V <sub>SS</sub>	NC	DQ <sub>a</sub>
<b>F</b>	V <sub>DDQ</sub>	NC	V <sub>SS</sub>	$\overline{\text{OE}}$	V <sub>SS</sub>	DQ <sub>a</sub>	V <sub>DDQ</sub>
<b>G</b>	NC	DQ <sub>b</sub>	$\overline{\text{BW}}_b$	A	V <sub>SS</sub>	NC	DQ <sub>a</sub>
<b>H</b>	DQ <sub>b</sub>	NC	V <sub>SS</sub>	$\overline{\text{WE}}$	V <sub>SS</sub>	DQ <sub>a</sub>	NC
<b>J</b>	V <sub>DDQ</sub>	V <sub>DD</sub>	NC	V <sub>DD</sub>	NC	V <sub>DD</sub>	V <sub>DDQ</sub>
<b>K</b>	NC	DQ <sub>b</sub>	V <sub>SS</sub>	CLK	V <sub>SS</sub>	NC	DQ <sub>a</sub>
<b>L</b>	DQ <sub>b</sub>	NC	V <sub>SS</sub>	NC	$\overline{\text{BW}}_a$	DQ <sub>a</sub>	NC
<b>M</b>	V <sub>DDQ</sub>	DQ <sub>b</sub>	V <sub>SS</sub>	$\overline{\text{CKE}}$	V <sub>SS</sub>	NC	V <sub>DDQ</sub>
<b>N</b>	DQ <sub>b</sub>	NC	V <sub>SS</sub>	A <sub>1</sub> *	V <sub>SS</sub>	DQ <sub>a</sub>	NC
<b>P</b>	NC	DQP <sub>b</sub>	V <sub>SS</sub>	A <sub>0</sub> *	V <sub>SS</sub>	NC	DQ <sub>a</sub>
<b>R</b>	NC	A	$\overline{\text{LBO}}$	V <sub>DD</sub>	NC	A	NC
<b>T</b>	NC	A	A	NC	A	A	ZZ
<b>U</b>	V <sub>DDQ</sub>	NC	NC	NC	NC	NC	V <sub>DDQ</sub>

**Note :** \* A<sub>0</sub> and A<sub>1</sub> are the two least significant bits(LSB) of the address field and set the internal burst counter if burst is desired.

**PIN NAME**

SYMBOL	PIN NAME	SYMBOL	PIN NAME
A	Address Inputs	V <sub>DD</sub>	Power Supply
A <sub>0</sub> ,A <sub>1</sub>	Burst Address Inputs	V <sub>SS</sub>	Ground
ADV	Address Advance/Load	N.C.	No Connect
$\overline{\text{WE}}$	Read/Write Control Input		
CLK	Clock		
$\overline{\text{CKE}}$	Clock Enable	DQ <sub>a</sub>	Data Inputs/Outputs
$\overline{\text{CS}}_1$	Chip Select	DQ <sub>b</sub>	Data Inputs/Outputs
$\overline{\text{CS}}_2$	Chip Select	DQP <sub>a</sub> , P <sub>b</sub>	Data Inputs/Outputs
$\overline{\text{CS}}_2$	Chip Select		
$\overline{\text{BW}}_x$ (x=a,b)	Byte Write Inputs	V <sub>DDQ</sub>	Output Power Supply
$\overline{\text{OE}}$	Output Enable		
ZZ	Power Sleep Mode		
LBO	Burst Mode Control		

**FUNCTION DESCRIPTION**

The KM736S949 and KM718S049 are N<sub>t</sub>RAM™ designed to sustain 100% bus bandwidth by eliminating turnaround cycle when there is transition from Read to Write, or vice versa.

All inputs (with the exception of  $\overline{OE}$ ,  $\overline{LBO}$  and  $\overline{ZZ}$ ) are synchronized to rising clock edges.

All read, write and deselect cycles are initiated by the ADV input. Subsequent burst addresses can be internally generated by the burst advance pin (ADV). ADV should be driven to Low once the device has been deselected in order to load a new address for next operation.

Clock Enable( $\overline{CKE}$ ) pin allows the operation of the chip to be suspended as long as necessary. When  $\overline{CKE}$  is high, all synchronous inputs are ignored and the internal device registers will hold their previous values.

N<sub>t</sub>RAM™ latches external address and initiates a cycle, when  $\overline{CKE}$ , ADV are driven to low and all three chip enables( $\overline{CS1}$ ,  $\overline{CS2}$ ,  $\overline{CS2}$ ) are active .

Output Enable( $\overline{OE}$ ) can be used to disable the output at any given time.

Read operation is initiated when at the rising edge of the clock, the address presented to the address inputs are latched in the address register,  $\overline{CKE}$  is driven low, all three chip enables( $\overline{CS1}$ ,  $\overline{CS2}$ ,  $\overline{CS2}$ ) are active, the write enable input signals  $\overline{WE}$  are driven high, and ADV driven low. The internal array is read between the first rising edge and the second rising edge of the clock and the data is latched in the output register. At the second clock edge the data is driven out of the SRAM. Also during read operation  $\overline{OE}$  must be driven low for the device to drive out the requested data.

Write operation occurs when  $\overline{WE}$  is driven low at the rising edge of the clock.  $\overline{BW}[d:a]$  can be used for byte write operation. The pipelined N<sub>t</sub>RAM™ uses a late-late write cycle to utilize 100% of the bandwidth.

At the first rising edge of the clock,  $\overline{WE}$  and address are registered, and the data associated with that address is required two cycle later.

Subsequent addresses are generated by ADV High for the burst access as shown below. The starting point of the burst sequence is provided by the external address. The burst address counter wraps around to its initial state upon completion.

The burst sequence is determined by the state of the  $\overline{LBO}$  pin. When this pin is low, linear burst sequence is selected.

And when this pin is high, Interleaved burst sequence is selected.

During normal operation,  $\overline{ZZ}$  must be driven low. When  $\overline{ZZ}$  is driven high, the SRAM will enter a Power Sleep Mode after 2 cycles. At this time, internal state of the SRAM is preserved. When  $\overline{ZZ}$  returns to low, the SRAM normally operates after 2 cycles of wake up time.

**BURST SEQUENCE TABLE**

(Interleaved Burst,  $\overline{LBO}$ =High)

$\overline{LBO}$ PIN	HIGH	Case 1		Case 2		Case 3		Case 4	
		A1	A0	A1	A0	A1	A0	A1	A0
	First Address	0	0	0	1	1	0	1	1
	↓	0	1	0	0	1	1	1	0
	↓	1	0	1	1	0	0	0	1
	Fourth Address	1	1	1	0	0	1	0	0

(Linear Burst,  $\overline{LBO}$ =Low)

$\overline{LBO}$ PIN	LOW	Case 1		Case 2		Case 3		Case 4	
		A1	A0	A1	A0	A1	A0	A1	A0
	First Address	0	0	0	1	1	0	1	1
	↓	0	1	1	0	1	1	0	0
	↓	1	0	1	1	0	0	0	1
	Fourth Address	1	1	0	0	0	1	1	0

**Note** : 1.  $\overline{LBO}$  pin must be tied to High or Low, and Floating State must not be allowed.

STATE DIAGRAM FOR NtRAM™

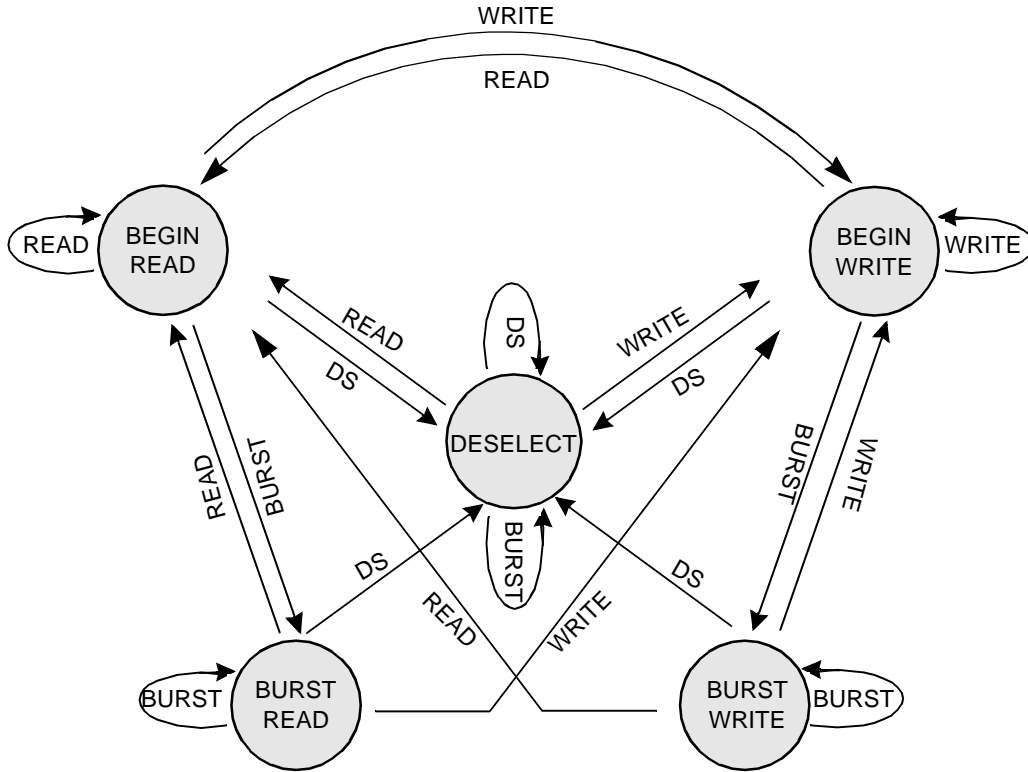

COMMAND	ACTION
DS	DESELECT
READ	BEGIN READ
WRITE	BEGIN WRITE
BURST	BEGIN READ BEGIN WRITE CONTINUE DESELECT

Notes : 1. An IGNORE CLOCK EDGE cycle is not shown in the above diagram. This is because CKE HIGH only blocks the clock(CLK) input and does not change the state of the device.  
2. States change on the rising edge of the clock(CLK)



**TRUTH TABLES**

**SYNCHRONOUS TRUTH TABLE**

$\overline{CS}_1$	$\overline{CS}_2$	$\overline{CS}_2$	ADV	$\overline{WE}$	$\overline{BW}_x$	$\overline{OE}$	$\overline{CKE}$	CLK	ADDRESS ACCESSED	Operation
H	X	X	L	X	X	X	L	↑	N/A	Not Selected
X	L	X	L	X	X	X	L	↑	N/A	Not Selected
X	X	H	L	X	X	X	L	↑	N/A	Not Selected
X	X	X	H	X	X	X	L	↑	N/A	Not Selected Continue
L	H	L	L	H	X	L	L	↑	External Address	Begin Burst Read Cycle
X	X	X	H	X	X	L	L	↑	Next Address	Continue Burst Read Cycle
L	H	L	L	H	X	H	L	↑	External Address	NOP/Dummy Read
X	X	X	H	X	X	H	L	↑	Next Address	Dummy Read
L	H	L	L	L	L	X	L	↑	External Address	Begin Burst Write Cycle
X	X	X	H	X	L	X	L	↑	Next Address	Continue Burst Write Cycle
L	H	L	L	L	H	X	L	↑	N/A	NOP/Write Abort
X	X	X	H	X	H	X	L	↑	Next Address	Write Abort
X	X	X	X	X	X	X	H	↑	Current Address	Ignore Clock

- Notes :** 1. X means "Don't Care". 2. The rising edge of clock is symbolized by (↑).  
 3. A continue deselect cycle can only be entered if a deselect cycle is executed first.  
 4.  $\overline{WRITE} = L$  means Write operation in WRITE TRUTH TABLE.  
 $\overline{WRITE} = H$  means Read operation in WRITE TRUTH TABLE.  
 5. Operation finally depends on status of asynchronous input pins(ZZ and  $\overline{OE}$ ).

**WRITE TRUTH TABLE(x36)**

$\overline{WE}$	$\overline{BW}_a$	$\overline{BW}_b$	$\overline{BW}_c$	$\overline{BW}_d$	OPERATION
H	X	X	X	X	READ
L	L	H	H	H	WRITE BYTE a
L	H	L	H	H	WRITE BYTE b
L	H	H	L	H	WRITE BYTE c
L	H	H	H	L	WRITE BYTE d
L	L	L	L	L	WRITE ALL BYTES
L	H	H	H	H	WRITE ABORT/NOP

- Notes :** 1. X means "Don't Care".  
 2. All inputs in this table must meet setup and hold time around the rising edge of CLK(↑).

**WRITE TRUTH TABLE(x18)**

$\overline{WE}$	$\overline{BW}_a$	$\overline{BW}_b$	OPERATION
H	X	X	READ
L	L	H	WRITE BYTE a
L	H	L	WRITE BYTE b
L	L	L	WRITE ALL BYTES
L	H	H	WRITE ABORT/NOP

- Notes :** 1. X means "Don't Care".  
 2. All inputs in this table must meet setup and hold time around the rising edge of CLK(↑).

**ASYNCHRONOUS TRUTH TABLE**

OPERATION	ZZ	$\overline{OE}$	I/O STATUS
Sleep Mode	H	X	High-Z
Read	L	L	DQ
	L	H	High-Z
Write	L	X	Din, High-Z
Deselected	L	X	High-Z

**Notes**

1. X means "Don't Care".
2. Sleep Mode means power Sleep Mode of which stand-by current does not depend on cycle time.
3. Deselected means power Sleep Mode of which stand-by current depends on cycle time.

**ABSOLUTE MAXIMUM RATINGS\***

PARAMETER	SYMBOL	RATING	UNIT
Voltage on VDD Supply Relative to VSS	VDD	-0.3 to 3.6	V
Voltage on Any Other Pin Relative to VSS	VIN	-0.3 to 3.6	V
Power Dissipation	Pd	1.6	W
Storage Temperature	TSTG	-65 to 150	°C
Operating Temperature	TOPR	0 to 70	°C
Storage Temperature Range Under Bias	TBIAS	-10 to 85	°C

\*Note : Stresses greater than those listed under "Absolute Maximum Ratings" may cause permanent damage to the device. This is a stress rating only and functional operation of the device at these or any other conditions above those indicated in the operating sections of this specification is not implied. Exposure to absolute maximum rating conditions for extended periods may affect reliability.

**OPERATING CONDITIONS** (0°C ≤ TA ≤ 70°C)

PARAMETER	SYMBOL	MIN	Typ.	MAX	UNIT
Supply Voltage	VDD	2.375	2.5	2.625	V
	VDDQ	2.375	2.5	2.625	V
Ground	VSS	0	0	0	V

**CAPACITANCE\*** (TA=25°C, f=1MHz)

Parameter	Symbol	Test Condition	Min	Max	Unit
Input Capacitance	CIN	VIN=0V	-	7	pF
Output Capacitance	COUT	VOUT=0V	-	9	pF

\*Notes : Sampled not 100% tested.

**DC ELECTRICAL CHARACTERISTICS**( $V_{DD}=2.5V\pm 5\%$ ,  $T_A=0^{\circ}C$  to  $+70^{\circ}C$ )

PARAMETER	SYMBOL	TEST CONDITIONS	MIN	MAX	UNIT	NOTES	
Input Leakage Current(except ZZ)	IIL	$V_{DD}=\text{Max}$ ; $V_{IN}=V_{SS}$ to $V_{DD}$	-2	+2	$\mu A$		
Output Leakage Current	IOL	Output Disabled, $V_{out}=V_{SS}$ to $V_{DDQ}$	-2	+2	$\mu A$		
Operating Current	ICC	Device Selected, $I_{OUT}=0mA$ , $ZZ\leq V_{IL}$ , Cycle Time $\geq t_{CYC}$ Min	-60	-	320	mA	1,2
			-67	-	300		
			-75	-	280		
			-10	-	250		
Standby Current	ISB	Device deselected, $I_{OUT}=0mA$ , $ZZ\leq V_{IL}$ , $f=\text{Max}$ , All Inputs $\leq 0.2V$ or $\geq V_{DD}-0.2V$	-60	-	70	mA	
			-67	-	60		
			-75	-	50		
			-10	-	40		
	ISB1	Device deselected, $I_{OUT}=0mA$ , $ZZ\leq 0.2V$ , $f=0$ , All Inputs=fixed ( $V_{DD}-0.2V$ or $0.2V$ )	-	-	30	mA	
ISB2	Device deselected, $I_{OUT}=0mA$ , $ZZ\geq V_{DD}-0.2V$ , $f=\text{Max}$ , All Inputs $\leq V_{IL}$ or $\geq V_{IH}$	-	-	30	mA		
Output Low Voltage	VoL	$I_{OL}=1.0mA$	-	0.4	V		
Output High Voltage	VoH	$I_{OH}=-1.0mA$	2.0	-	V		
Input Low Voltage	VIL		-0.3*	0.7	V		
Input High Voltage	VIH		1.7	$V_{DD}+0.5^{**}$	V	3	

**Notes** : 1. Reference AC Operating Conditions and Characteristics for input and timing.  
2. Data states are all zero.  
3. In Case of I/O Pins, the Max.  $V_{IH}=V_{DD}+0.3V$

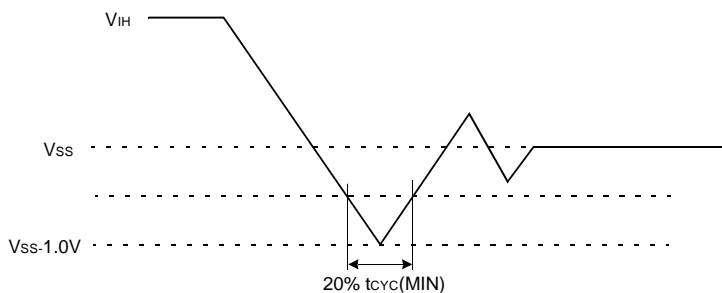

**TEST CONDITIONS**

( $V_{DD}=3.3V\pm 5\%$ ,  $T_A=0$  to  $70^{\circ}C$ )

PARAMETER	VALUE
Input Pulse Level	0 to 2.5V
Input Rise and Fall Time(Measured at 20% to 80% )	1.0V/ns
Input and Output Timing Reference Levels	1.25V
Output Load	See Fig. 1

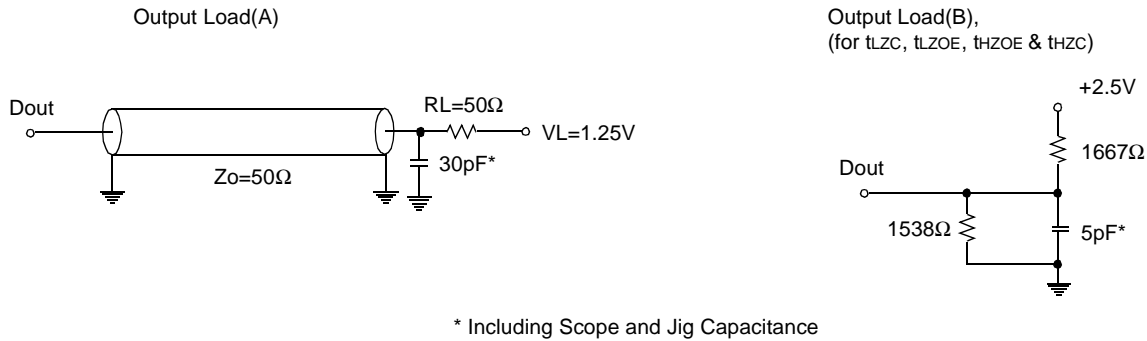

**Fig. 1**

**AC TIMING CHARACTERISTICS**(V<sub>DD</sub>=2.5V±5%, T<sub>A</sub>=0 to 70°C)

PARAMETER	SYMBOL	-60		-67		-75		-10		UNIT
		MIN	MAX	MIN	MAX	MIN	MAX	MIN	MAX	
Cycle Time	t <sub>CYC</sub>	6.0	-	6.7	-	7.5	-	10.0	-	ns
Clock Access Time	t <sub>CD</sub>	-	3.5	-	3.8	-	4.2	-	5.0	ns
Output Enable to Data Valid	t <sub>OE</sub>	-	3.5	-	3.8	-	4.2	-	5.0	ns
Clock High to Output Low-Z	t <sub>LZC</sub>	1.5	-	1.5	-	1.5	-	1.5	-	ns
Output Hold from Clock High	t <sub>OH</sub>	1.5	-	1.5	-	1.5	-	1.5	-	ns
Output Enable Low to Output Low-Z	t <sub>LZOE</sub>	0	-	0	-	0	-	0	-	ns
Output Enable High to Output High-Z	t <sub>HZOE</sub>	-	3.0	-	3.0	-	3.5	-	3.5	ns
Clock High to Output High-Z	t <sub>HZC</sub>	-	3.0	-	3.0	-	3.5	-	3.5	ns
Clock High Pulse Width	t <sub>CH</sub>	2.2	-	2.5	-	3.0	-	3.0	-	ns
Clock Low Pulse Width	t <sub>CL</sub>	2.2	-	2.5	-	3.0	-	3.0	-	ns
Address Setup to Clock High	t <sub>AS</sub>	1.5	-	1.5	-	1.5	-	1.5	-	ns
CKE Setup to Clock High	t <sub>CES</sub>	1.5	-	1.5	-	1.5	-	1.5	-	ns
Data Setup to Clock High	t <sub>DS</sub>	1.5	-	1.5	-	1.5	-	1.5	-	ns
Write Setup to Clock High ( $\overline{WE}$ , $\overline{BWx}$ )	t <sub>WS</sub>	1.5	-	1.5	-	1.5	-	1.5	-	ns
Address Advance Setup to Clock High	t <sub>ADVS</sub>	1.5	-	1.5	-	1.5	-	1.5	-	ns
Chip Select Setup to Clock High	t <sub>CSS</sub>	1.5	-	1.5	-	1.5	-	1.5	-	ns
Address Hold from Clock High	t <sub>AH</sub>	0.5	-	0.5	-	0.5	-	0.5	-	ns
CKE Hold from Clock High	t <sub>CEH</sub>	0.5	-	0.5	-	0.5	-	0.5	-	ns
Data Hold from Clock High	t <sub>DH</sub>	0.5	-	0.5	-	0.5	-	0.5	-	ns
Write Hold from Clock High ( $\overline{WE}$ , $\overline{BWx}$ )	t <sub>WH</sub>	0.5	-	0.5	-	0.5	-	0.5	-	ns
Address Advance Hold from Clock High	t <sub>ADVH</sub>	0.5	-	0.5	-	0.5	-	0.5	-	ns
Chip Select Hold from Clock High	t <sub>CSH</sub>	0.5	-	0.5	-	0.5	-	0.5	-	ns
ZZ High to Power Down	t <sub>PDS</sub>	2	-	2	-	2	-	2	-	cycle
ZZ Low to Power Up	t <sub>PUS</sub>	2	-	2	-	2	-	2	-	cycle

**Notes :**

1. All address inputs must meet the specified setup and hold times for all rising clock(CLK) edges when ADV is sampled low and  $\overline{CS}$  is sampled low. All other synchronous inputs must meet the specified setup and hold times whenever this device is chip selected.
2. Chip selects must be valid at each rising edge of CLK(when ADV is Low) to remain enabled.
3. A write cycle is defined by  $\overline{WE}$  low having been registered into the device at ADV Low, A Read cycle is defined by  $\overline{WE}$  High with ADV Low, Both cases must meet setup and hold times.
4. To avoid bus contention, At a given voltage and temperature t<sub>LZC</sub> is more than t<sub>HZC</sub>.  
The specs as shown do not imply bus contention because t<sub>LZC</sub> is a Min. parameter that is worst case at totally different test conditions (0°C,2.625V) than t<sub>HZC</sub>, which is a Max. parameter(worst case at 70°C,2.375V)  
It is not possible for two SRAMs on the same board to be at such different voltage and temperature.

**SLEEP MODE**

SLEEP MODE is a low current, power-down mode in which the device is deselected and current is reduced to  $I_{SB2}$ . The duration of SLEEP MODE is dictated by the length of time the ZZ is in a High state.

After entering SLEEP MODE, all inputs except ZZ become disabled and all outputs go to High-Z

The ZZ pin is an asynchronous, active high input that causes the device to enter SLEEP MODE.

When the ZZ pin becomes a logic High,  $I_{SB2}$  is guaranteed after the time  $t_{ZZ1}$  is met. Any operation pending when entering SLEEP MODE is not guaranteed to successful complete. Therefore, SLEEP MODE (READ or WRITE) must not be initiated until valid pending operations are completed. Similarly, when exiting SLEEP MODE during  $t_{PUS}$ , only a DESELECT or READ cycle should be given while the SRAM is transitioning out of SLEEP MODE.

**SLEEP MODE ELECTRICAL CHARACTERISTICS**

DESCRIPTION	CONDITIONS	SYMBOL	MIN	MAX	UNITS
Current during SLEEP MODE	$ZZ \geq V_{IH}$	$I_{SB2}$		10	mA
ZZ active to input ignored		$t_{PDS}$	2		cycle
ZZ inactive to input sampled		$t_{PUS}$	2		cycle
ZZ active to SLEEP current		$t_{ZZ1}$		2	cycle
ZZ inactive to exit SLEEP current		$t_{RZZ1}$	0		

**SLEEP MODE WAVEFORM**

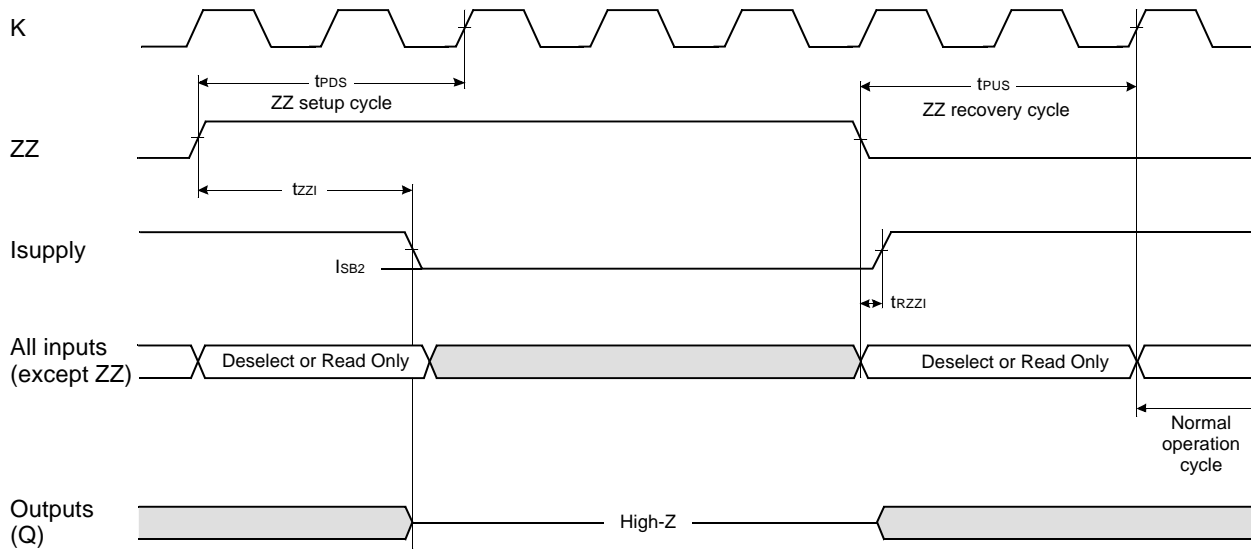

TIMING WAVEFORM OF READ CYCLE

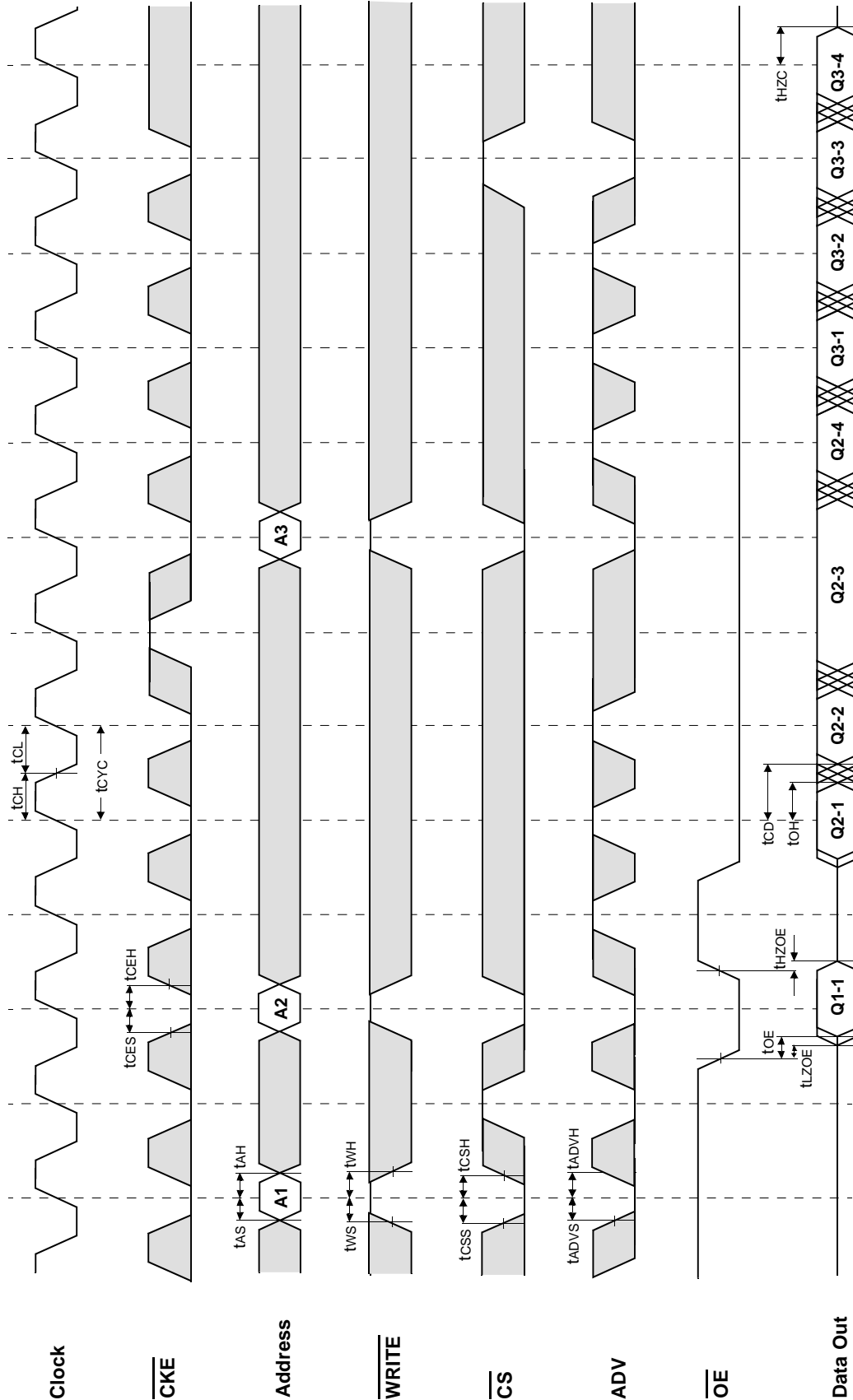

□ Don't Care  
▣ Undefined

NOTES:  $\overline{WRITE} = L$  means  $\overline{WE} = L$ , and  $\overline{BWx} = L$   
 $\overline{CS} = L$  means  $\overline{CS1} = L$ ,  $\overline{CS2} = H$  and  $\overline{CS2} = L$   
 $\overline{CS} = H$  means  $\overline{CS1} = H$ , or  $\overline{CS1} = L$  and  $\overline{CS2} = H$ , or  $\overline{CS1} = L$ , and  $\overline{CS2} = L$

TIMING WAVEFORM OF WRTE CYCLE

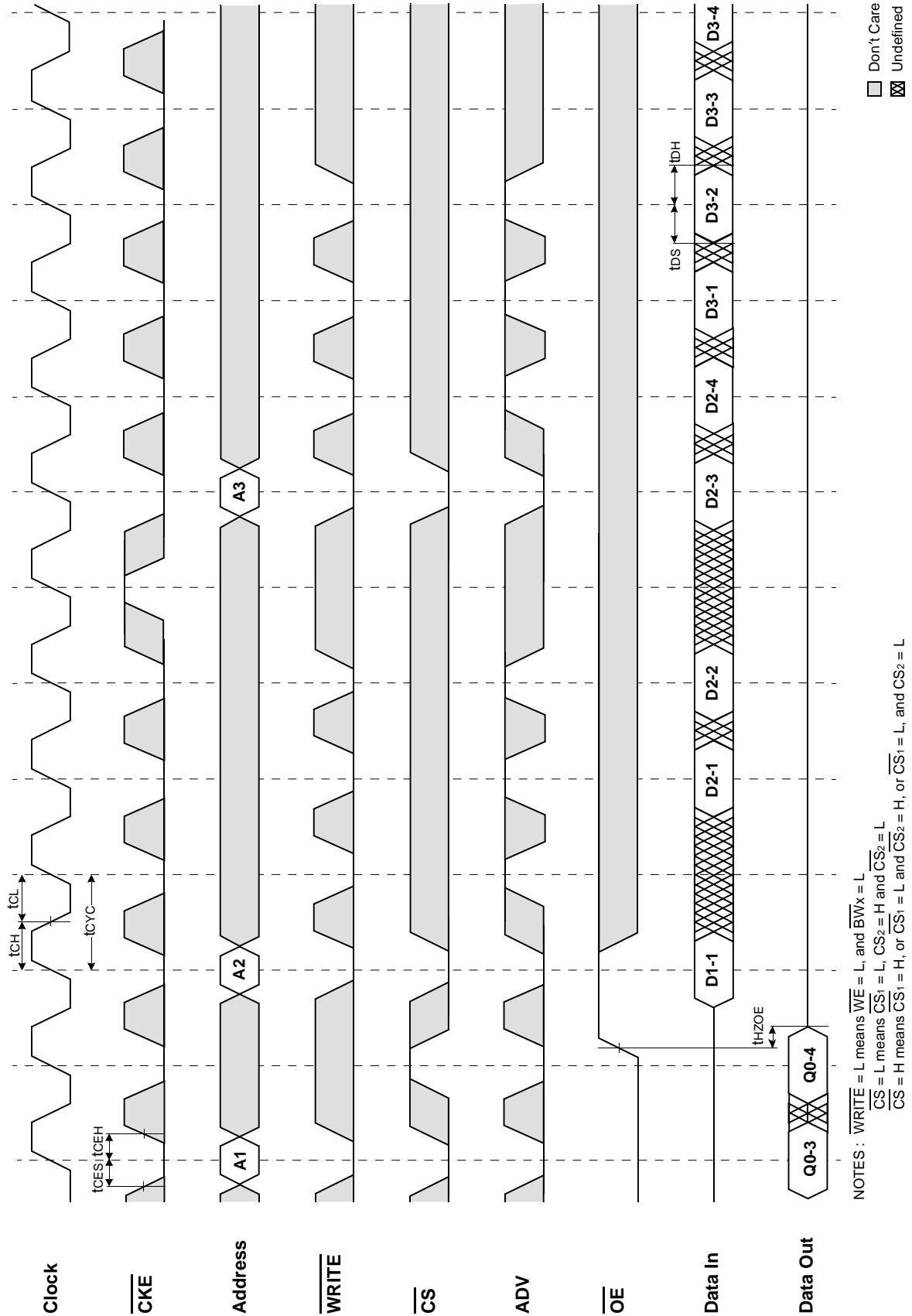

NOTES:  $\overline{WRITE} = L$  means  $\overline{WE} = L$ , and  $\overline{BWx} = L$   
 $\overline{CS} = L$  means  $\overline{CS1} = L$ ,  $\overline{CS2} = H$  and  $\overline{CS2} = L$   
 $\overline{CS} = H$  means  $\overline{CS1} = H$ , or  $\overline{CS1} = L$  and  $\overline{CS2} = H$ , or  $\overline{CS1} = L$ , and  $\overline{CS2} = L$

TIMING WAVEFORM OF SINGLE READWRITE

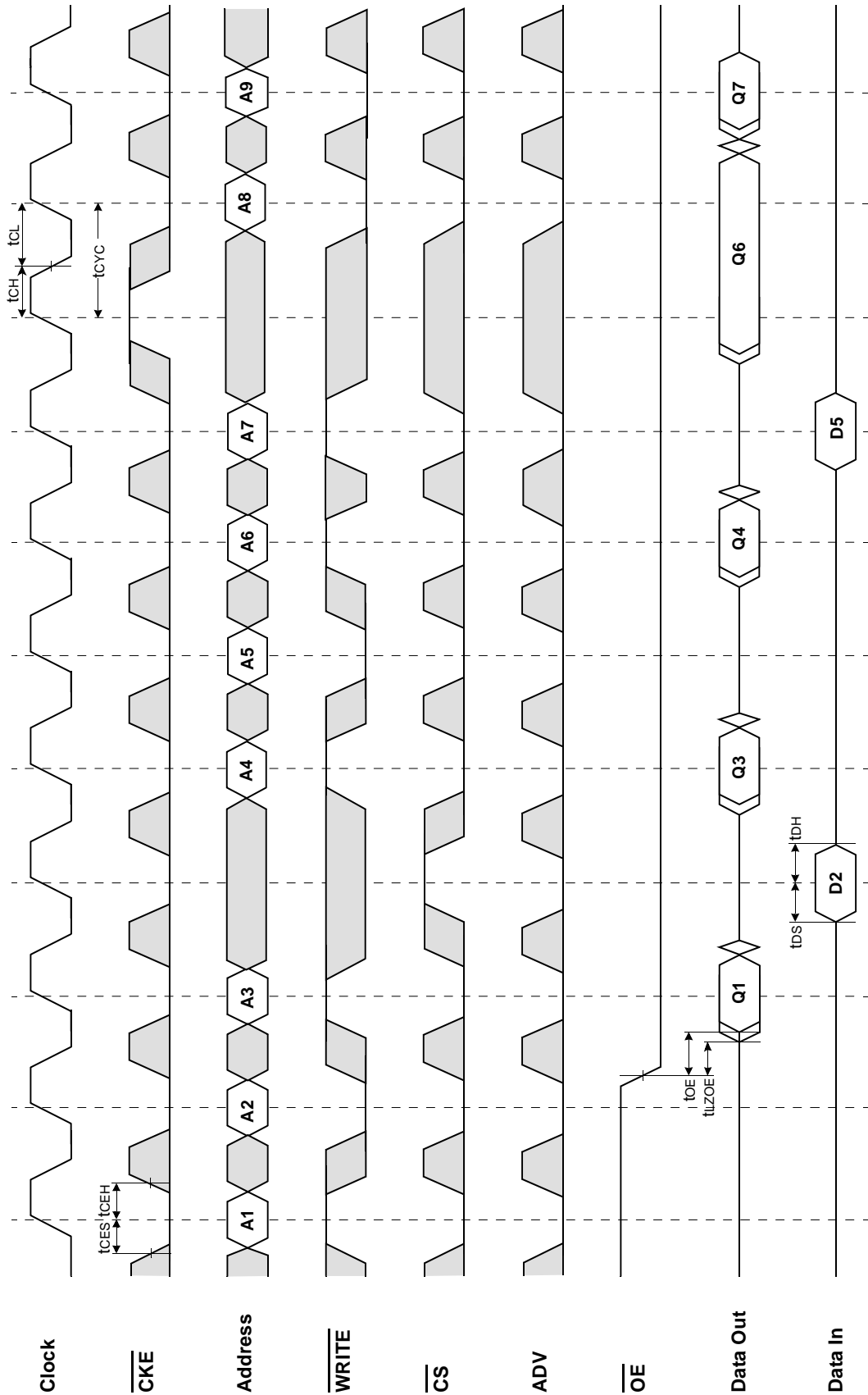

□ Don't Care  
⊠ Undefined

NOTES:  $\overline{\text{WRITE}} = \text{L}$  means  $\overline{\text{WE}} = \text{L}$ , and  $\overline{\text{BW}}_x = \text{L}$   
 $\overline{\text{CS}} = \text{L}$  means  $\overline{\text{CS}}_1 = \text{L}$ ,  $\overline{\text{CS}}_2 = \text{H}$  and  $\overline{\text{CS}}_2 = \text{L}$   
 $\overline{\text{CS}} = \text{H}$  means  $\overline{\text{CS}}_1 = \text{H}$ , or  $\overline{\text{CS}}_1 = \text{L}$  and  $\overline{\text{CS}}_2 = \text{H}$ , or  $\overline{\text{CS}}_1 = \text{L}$ , and  $\overline{\text{CS}}_2 = \text{L}$



TIMING WAVEFORM OF CKE OPERATION

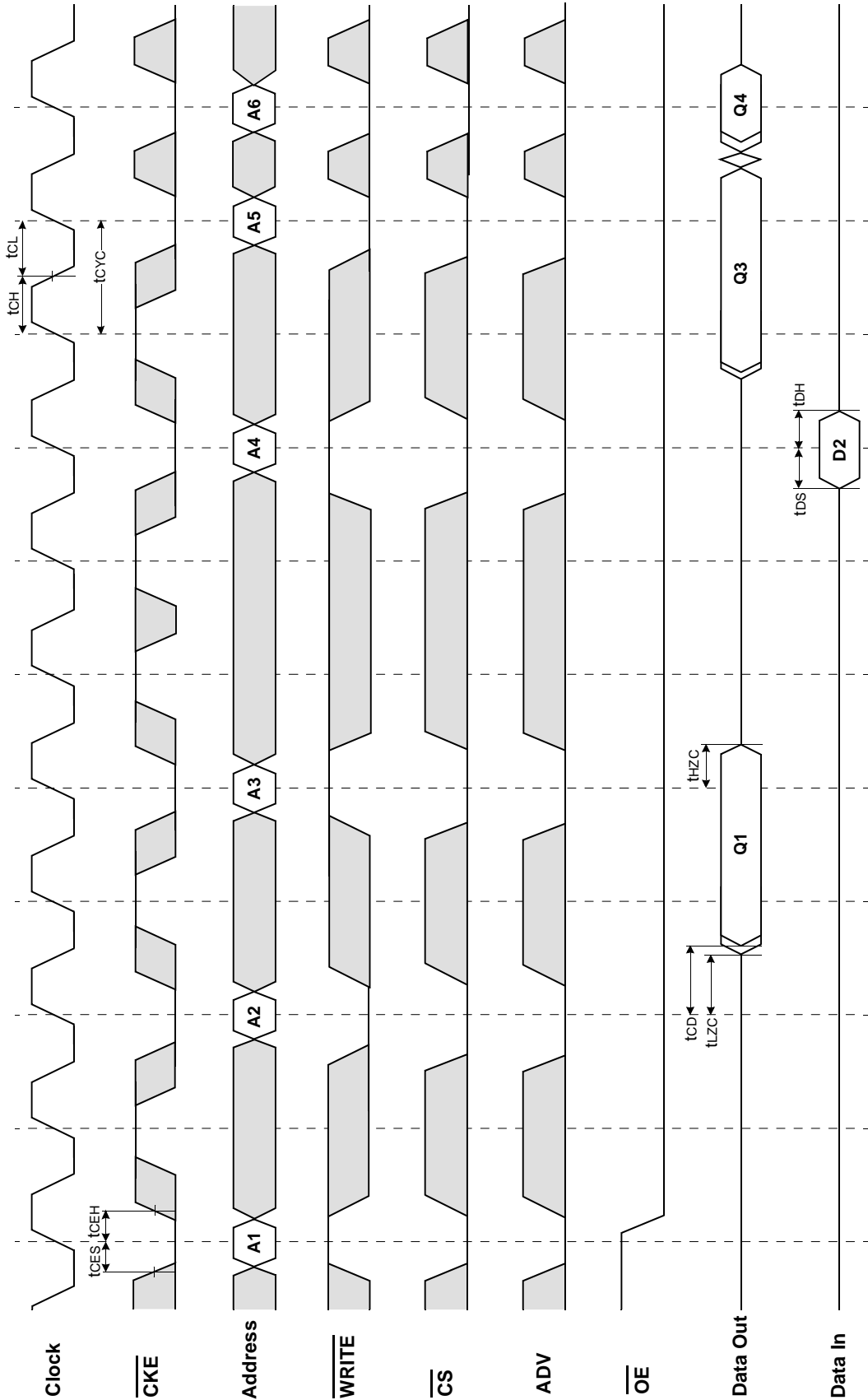

Don't Care  
 Undefined

NOTES : WRITE = L means WE = L, and BWx = L  
CS = L means CS1 = L, CS2 = H and CS2 = L  
CS = H means CS1 = H, or CS1 = L and CS2 = H, or CS1 = L, and CS2 = L

TIMING WAVEFORM OF CS OPERATION

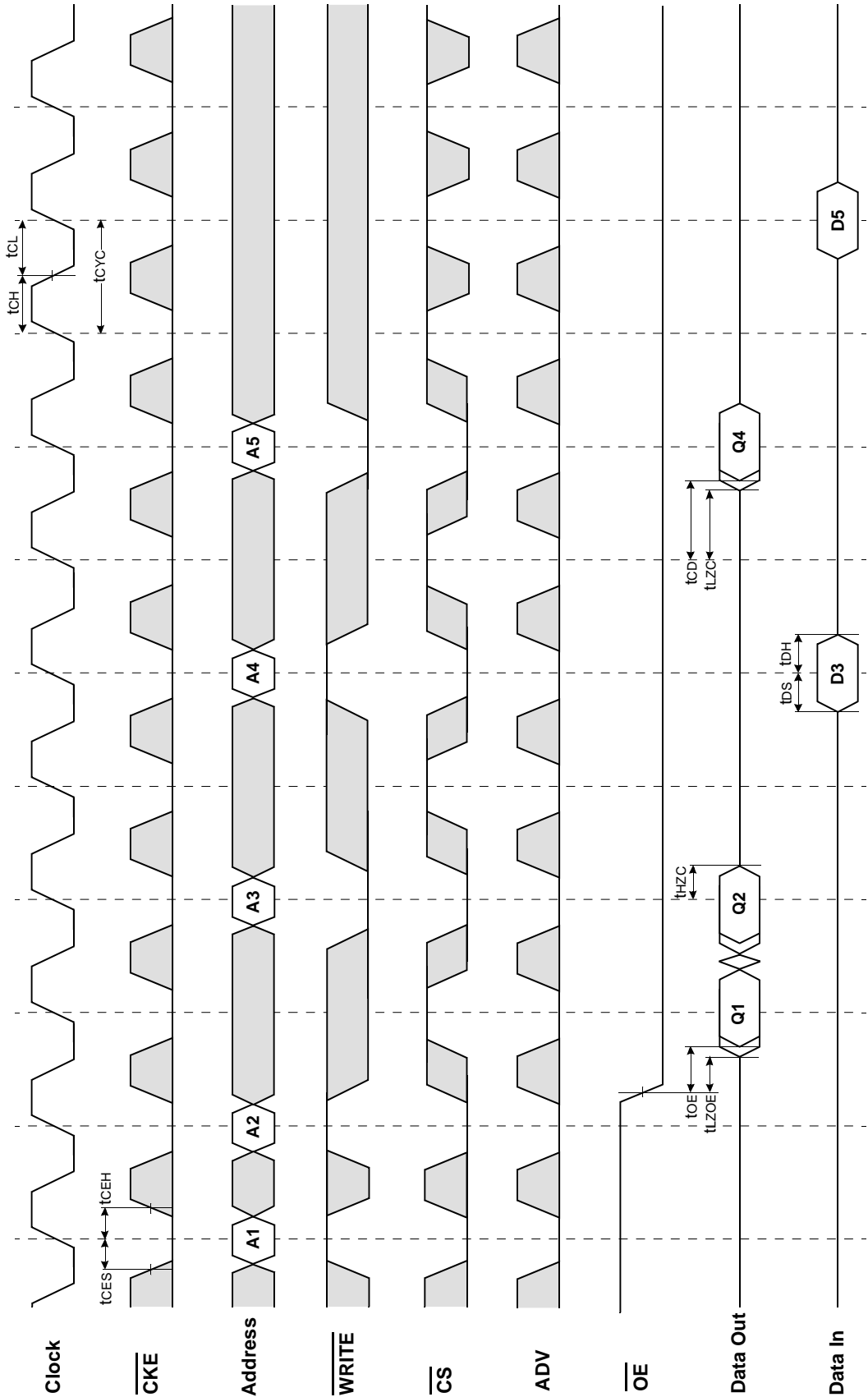

Don't Care  
 Undefined

NOTES : WRITE = L means WE = L, and BWx = L  
CS = L means CS<sub>1</sub> = L, CS<sub>2</sub> = H and CS<sub>2</sub> = L  
CS = H means CS<sub>1</sub> = H, or CS<sub>1</sub> = L and CS<sub>2</sub> = H, or CS<sub>1</sub> = L, and CS<sub>2</sub> = L

PACKAGE DIMENSIONS

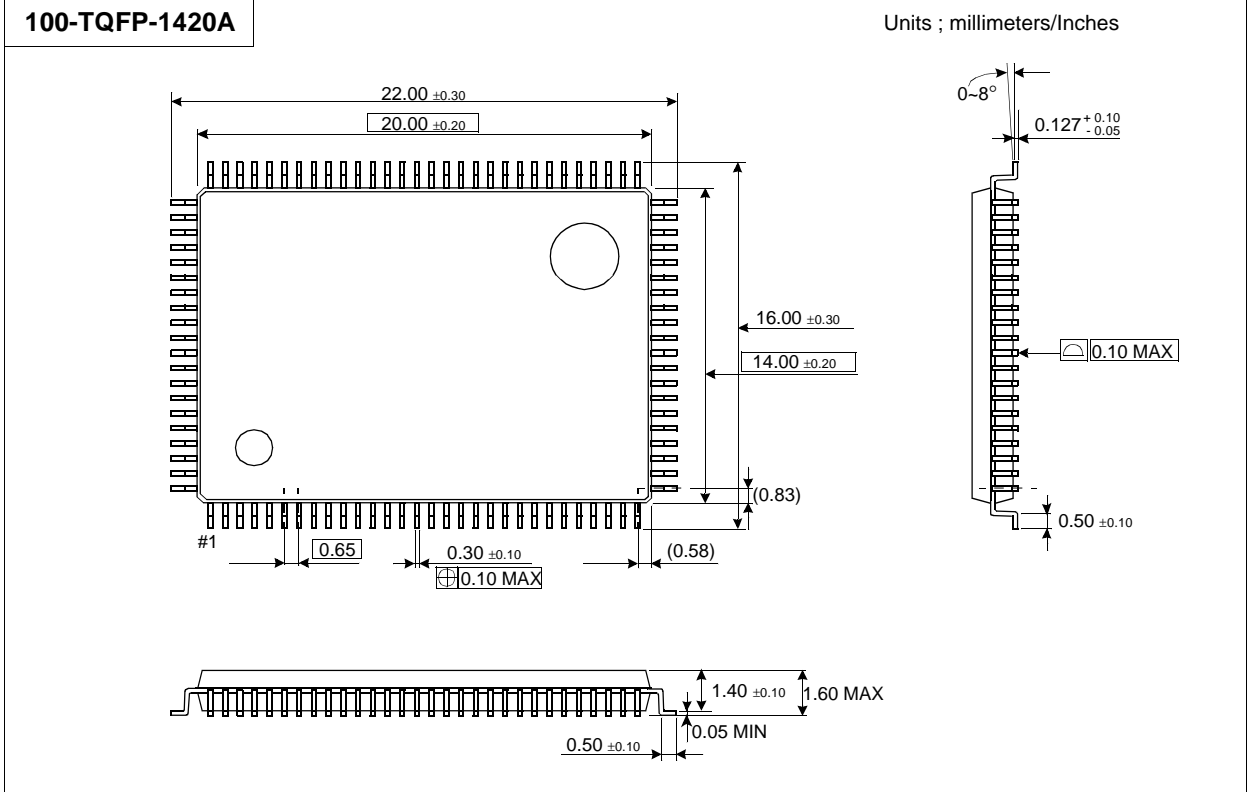

**119BGA PACKAGE DIMENSIONS**

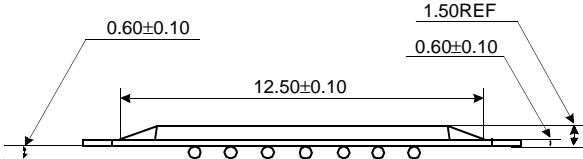
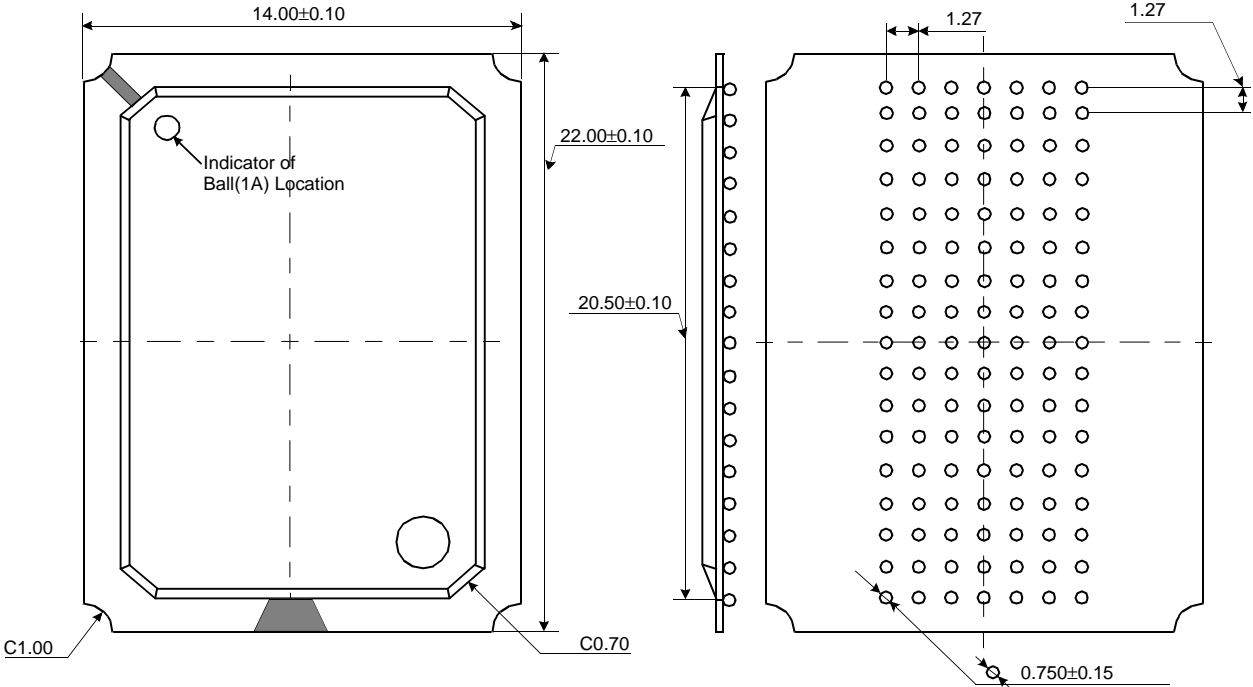

- NOTE :**
1. All Dimensions are in Millimeters.
  2. Solder Ball to PCB Offset : 0.10 MAX.
  3. PCB to Cavity Offset : 0.10 MAX.