

| PRODUCT NO. | COVER | MOUNT STYLE | STAND OFF | APPLICABLE HDR P/N | PACKAGING SPEC. | PRODUCT SPEC. |
|-------------|-------|-------------|-----------|--------------------|-----------------|---------------|
| 62607-22RO | - | ABOVE | 2.2 mm | 62598-22A | GESS-14-655 | 110-415 |
| 62607-22LO | - | | | | | |
| 62607-22ROC | WITH | | | | | |
| 62607-22LOC | WITH | | | | | |

| REVISIONS | | | | | |
|-----------|-------------|--------|-----|----------|--|
| REV | DESCRIPTION | ECN | BY | DATE | |
| A | RELEASED | J00367 | N.T | 8/2/00 | |
| B | REVISED | J10662 | M.H | 10/31/01 | |

10. 本品はタイプ1, 2カードに対応しています。
9. ピンヘッダへの組込はb部を水平になるように押さえ、本品と確実かん合させてから、c部をピンヘッダ上面まで押し込む。
8. 推奨体位置 (a部)。
7. 基板実装時の寸法を表す。
6. 推奨パターン寸法図はピンヘッダ製品図に示す。
5. 基板への取付はM2 x P0.4ネジ及び座金を各4個使用する。
4. 取付ネジ長さは使用する基板厚と*寸法を確認の上選定のこと。
3. 最大ネジ締め締付トルク: 0.245N・m (2.5kgf・cm)。
2. 本品はピンヘッダと合わせて使用する。
1. ボタンの色調は黒。
- (注記)

10. PC CARD TYPE L2 IS APPLICABLE.

9. AS MOUNTING METHOD TO PIN-HEADER, IT SHALL BE PUT MARKED PORTION b HORIZONTALLY AND BE FITTED ON COMPLETELY. THEN IT SHALL BE PUSHED MARKED PORTION c BY TOP SURFACE OF THE PIN-HEADER.
8. RECOMMENDED BODY POSITION (PART a).
7. SHOW P.C. BOARD MOUNTING DIMENSIONS.
6. SEE PIN-HEADER PRODUCT DRAWING FOR RECOMMENDED PATTERN DIMENSIONS.
5. 4-M2xP0.4 SCREW WITH WASHER ARE REQUIRED FOR FASTENING CONNECTOR TO P.C. BOARD.
4. DETERMINE MOUNTING SCREW LENGTH UPON CHECKING P.C. BOARD THICKNESS AND '*x' DIMENSION. ('*x' SHOWS REQUIRED SCREW LENGTH FROM MOUNTING SURFACE.)
3. MAXIMUM TIGHTENING TORQUE: 0.245N・m (2.5kgf・cm).
2. THIS PRODUCT USED WITH PIN-HEADER.
1. BUTTON COLOR IS BLACK.

NOTE

| | | | | | |
|----|-------------|-----|-----------------|-------------------------------|---------|
| ⑥ | NUT | 2 | STEEL | Zn PLATING | |
| ⑤ | SPACER | 2 | STEEL | Zn PLATING | |
| ④ | SHROUD | 1 | COPPER ALLOY | CONTACT AREA GOLD OVER NICKEL | |
| ③ | BUTTON | 1 | PBT | | 94HB |
| ② | BUTTON | 1 | ABS | | 94HB |
| ① | CASE | 2 | STAINLESS STEEL | | |
| NO | DESCRIPTION | QTY | MATERIAL | FINISH | REMARKS |

| SHEET INDEX | ISSUE | B | B | B | B | B | DATE | CUSTOMER | TITLE |
|---------------------------------------|--------|----------|---|-------------|---|----------|----------|------------------|--|
| | SH NO. | 1 | 2 | 3 | 4 | 5 | 10/31/01 | COPY | S/D SMTL CARDBUS EJECT MECH FOLDABLE ABOVE MOUNT |
| TOLERANCES UNLESS OTHERWISE SPECIFIED | | MAT | | OR | | DATE | | CUSTOMER | |
| | | SEE NOTE | | M. Kasagawa | | 10/31/01 | | COPY | |
| LINEAR | | FINISH | | CHK | | DATE | | THIRD ANGLE PROJ | |
| | | — | | M. Kasagawa | | 10/31/01 | | SCALE | |
| ANGLES | | | | M. Kasagawa | | 10/31/01 | | 3/2 C | |
| UNIT | | | | | | | | MM | |
| DWG. NO. | | | | | | | | 62607 | |
| REV | | | | | | | | B | |
| SHEET | | | | | | | | 1 of 5 | |

0F-003A REV. 0

DO NOT SCALE PRINT THIS INFORMATION IS CONFIDENTIAL AND IS DISCLOSED TO YOU ON CONDITION THAT NO FURTHER DISCLOSURE IS MADE BY YOU TO OTHER THAN FCI PERSONNEL WITHOUT WRITTEN AUTHORIZATION FROM FCI JAPAN K.K.

PRODUCT NO.

62607-22RO

REVISIONS

| REV | DESCRIPTION | ECN | BY | DATE |
|-----|-------------|--------|-----|----------|
| A | RELEASED | J00367 | N.T | 6/27/00 |
| B | REVISED | J10662 | M.H | 10/31/01 |

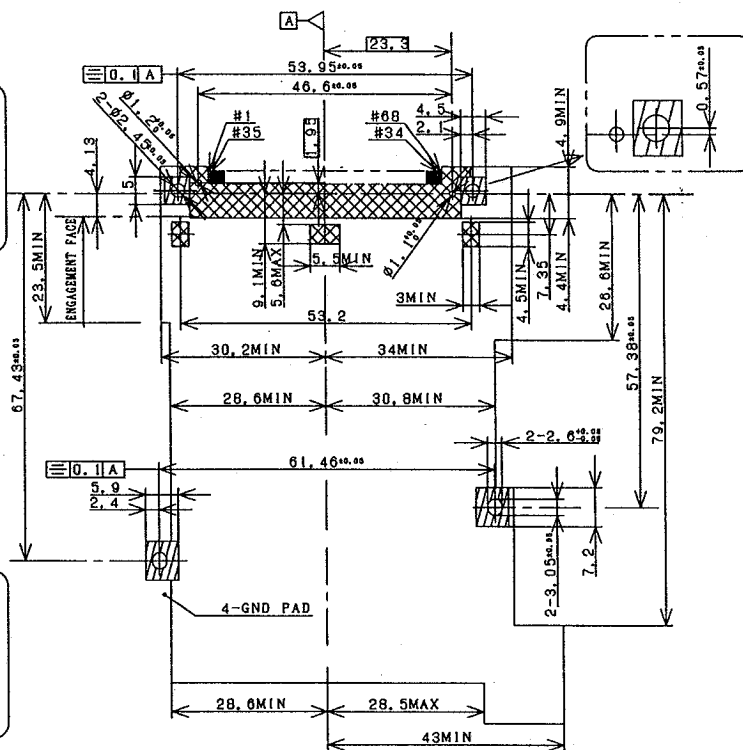
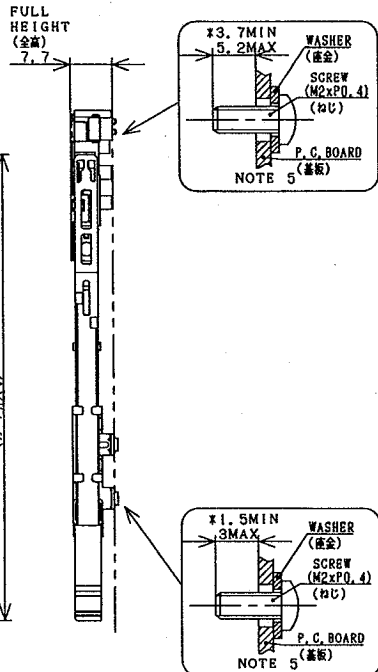
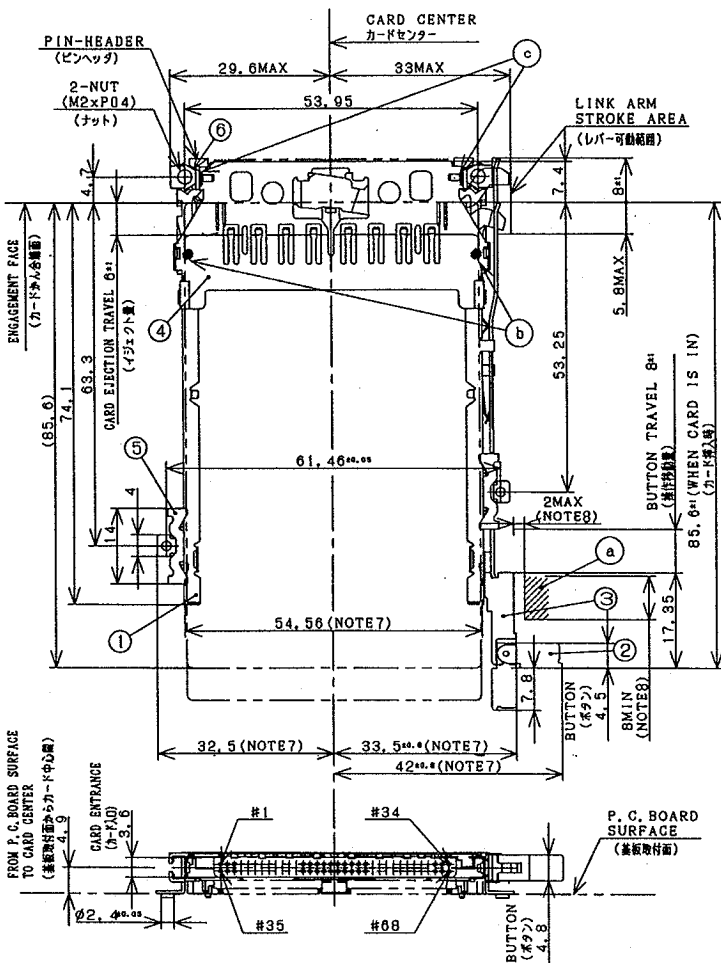

RECOMMENDED P.C. BOARD LAYOUT
(MOUNTING FACE SIDE)
推奨基板取付寸法図 (実装面側)

NO PART MOUNTING
(部品実装禁止領域)

MOUNTED PART HEIGHT 1.8MAX
(実装可能部品高さ)

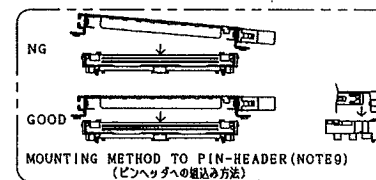

| 許容差の指定なき寸法公差 | |
|---------------|------|
| 10 以下 | ±0.3 |
| 10 をこえ 100 未満 | ±0.5 |
| 100 以上 | ±0.8 |
| 角 度 | ±3° |

| SHEET INDEX | ISSUE SH NO. | TOLERANCES UNLESS OTHERWISE SPECIFIED | MAT | DR | ENG | DATE | CUSTOMER COPY | TITLE | SCALE | SIZE | DWG. NO. | REV | SHEET |
|-------------|--------------|---------------------------------------|--------|-------------|-------------|------------------|---------------|---|-------|------|----------|-----|-------|
| | | SEE NOTE | | M. Kasagawa | M. Kasagawa | 10/31/01 | | S/D SMIL CARBUS EJECT MECH FOLDABLE ABOVE MOUNT | 3/2 | C | 62607 | B | 2 of |
| LINEAR | | | FINISH | CHK | 10/31/01 | THIRD ANGLE PROJ | | | | | | | |
| ANGLES | | | | | | UNIT | | | | | | | |

DO NOT SCALE. PRINT THIS INFORMATION IS CONFIDENTIAL AND IS DISCLOSED TO YOU ON CONDITION THAT NO FURTHER DISCLOSURE IS MADE BY YOU TO OTHER THAN FCI PERSONNEL WITHOUT WRITTEN AUTHORIZATION FROM FCI JAPAN K.K.

| REVISIONS | | | | |
|-----------|-------------|--------|-----|----------|
| REV | DESCRIPTION | ECN | BY | DATE |
| A | RELEASED | J00367 | N.T | 8/2/00 |
| B | REVISED | J10662 | M.H | 10/31/01 |

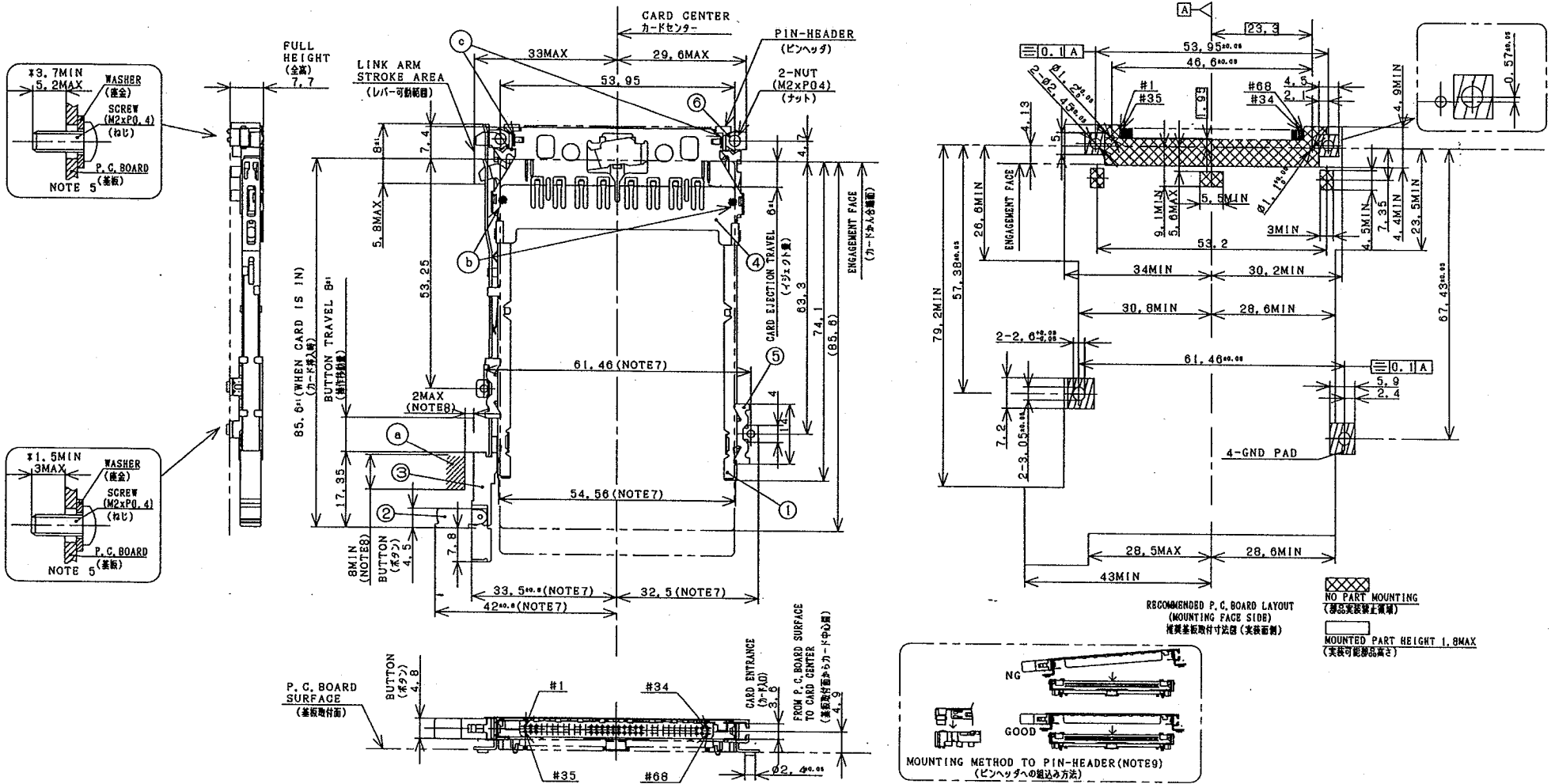

| 許容差の指定なき寸法公差 | |
|--------------|------|
| 10 以下 | ±0.3 |
| 10をこえ100未満 | ±0.5 |
| 100 以上 | ±0.8 |
| 角 度 | ±3' |

| | | | | | |
|-------------|--------------|---------------------------------------|--------------|-------------------------------|------------------|
| SHEET INDEX | ISSUE SH NO. | TOLERANCES UNLESS OTHERWISE SPECIFIED | MAT SEE NOTE | OR H. Kasagawa DATE 10/31/01 | CUSTOMER COPY |
| LINEAR | | | | ENG H. Kasagawa DATE 10/31/01 | |
| ANGLES | | | | CHK N. Saito DATE 10/16/01 | THIRD ANGLE PROJ |
| | | | | DR. Saito DATE 10/16/01 | UNIT mm |

FCI

TITLE: S/D SMIL CARBUS EJECT MECH FOLDABLE ABOVE MOUNT

SCALE: 3/2 SIZE: C DWS. NO.: 62607 [REV] SHEET: B 3 of

DF-003A REV. D
DO NOT SCALE PRINT THIS INFORMATION IS CONFIDENTIAL AND IS DISCLOSED TO YOU ON CONDITION THAT NO FURTHER DISCLOSURE IS MADE BY YOU TO OTHER THAN FCI PERSONNEL WITHOUT WRITTEN AUTHORIZATION FROM FCI JAPAN K.K.

PRODUCT NO.
62607-22ROC

| REVISIONS | | | | |
|-----------|-------------|--------|-----|----------|
| REV | DESCRIPTION | ECN | BY | DATE |
| A | RELEASED | J00367 | N.T | 6/2/00 |
| B | REVISED | J10662 | M.H | 10/31/01 |

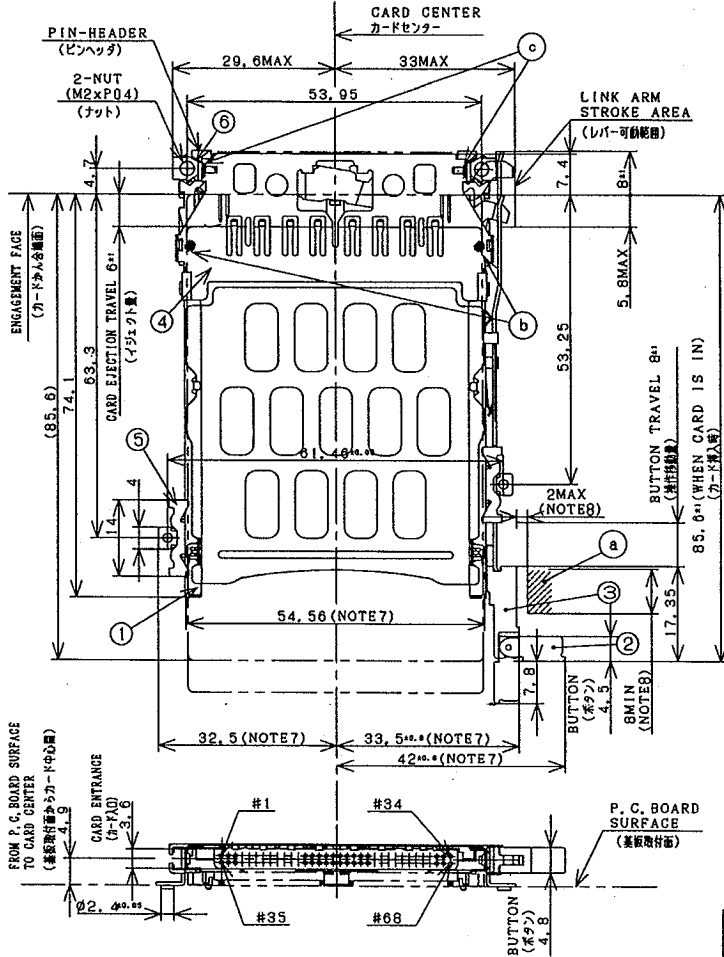

FULL HEIGHT
(全高)
7.7

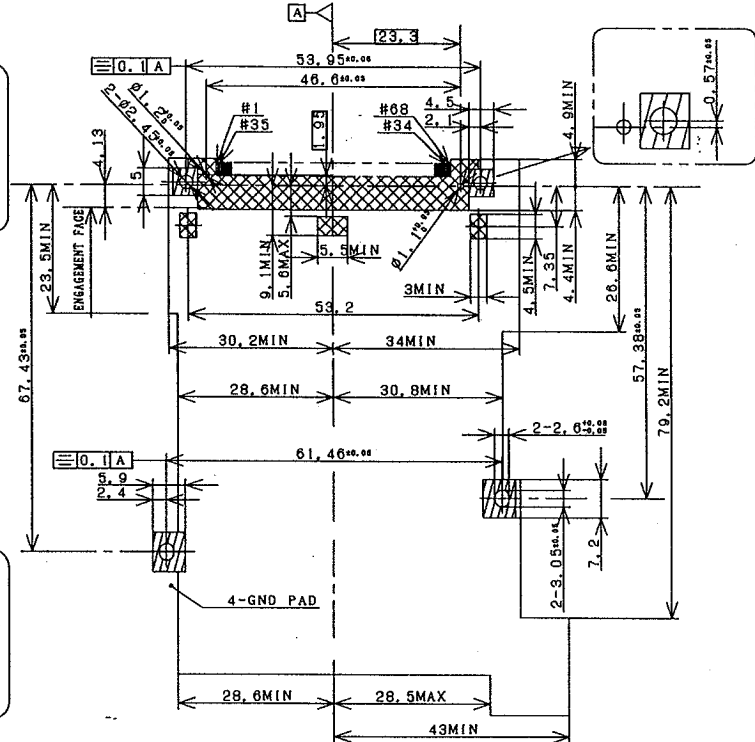
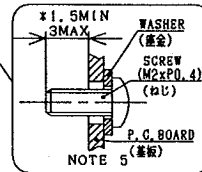
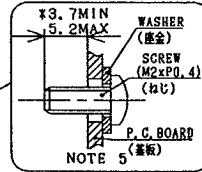

RECOMMENDED P.C. BOARD LAYOUT
(MOUNTING FACE SIDE)
推奨基板配付寸法図 (実装面側)

NO PART MOUNTING
(部品実装禁止領域)

MOUNTED PART HEIGHT 1.8MAX
(実装可能部品高さ)

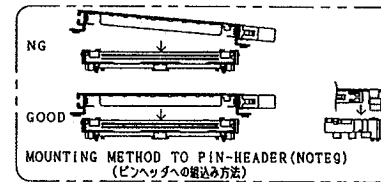

許容差の指定なき寸法公差

| | |
|------------|------|
| 10 以下 | ±0.3 |
| 10をこえ100未満 | ±0.5 |
| 100 以上 | ±0.8 |
| 角 度 | ±3° |

DF-003A REV D

DO NOT SCALE PRINT THIS INFORMATION IS CONFIDENTIAL AND IS DISCLOSED TO YOU ON CONDITION THAT NO FURTHER DISCLOSURE IS MADE BY YOU TO OTHER THAN FCI PERSONNEL WITHOUT WRITTEN AUTHORIZATION FROM FCI JAPAN K.K.

| SHEET INDEX | ISSUE | | MAT | OR | DATE | CUSTOMER COPY |
|-------------|---------------------------------------|----------|-----|----------------|----------|---------------|
| | SH NO. | DATE | | | | |
| LINEAR | TOLERANCES UNLESS OTHERWISE SPECIFIED | SEE NOTE | | H. Hasegawa | 10/31/01 | |
| | FINISH | CHK | | N. Ito | 10/31/01 | |
| ANGLES | | | | R. C. Spangler | 10/31/01 | |

| | | | | | | | |
|--|--|------------|--|---------|-----------------|--------|------------|
| FCI | | SCALE: 3/2 | | SIZE: C | DWG. NO.: 62607 | REV: B | SHEET: 40f |
| TITLE: S/D SMTIL CAROBUS EJECT MECH FOLDABLE ABOVE MOUNT | | | | | | | |

| REVISIONS | | | | |
|-----------|-------------|--------|-----|----------|
| REV | DESCRIPTION | ECN | BY | DATE |
| A | RELEASED | J00367 | N.T | 6/2/00 |
| B | REVISED | J10662 | M.H | 10/31/01 |

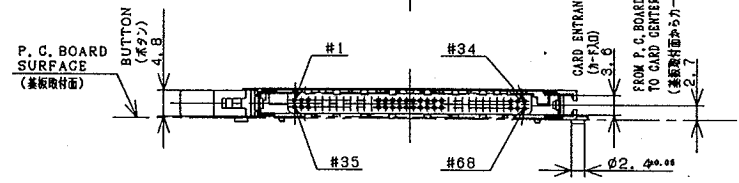
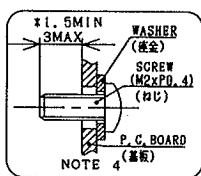
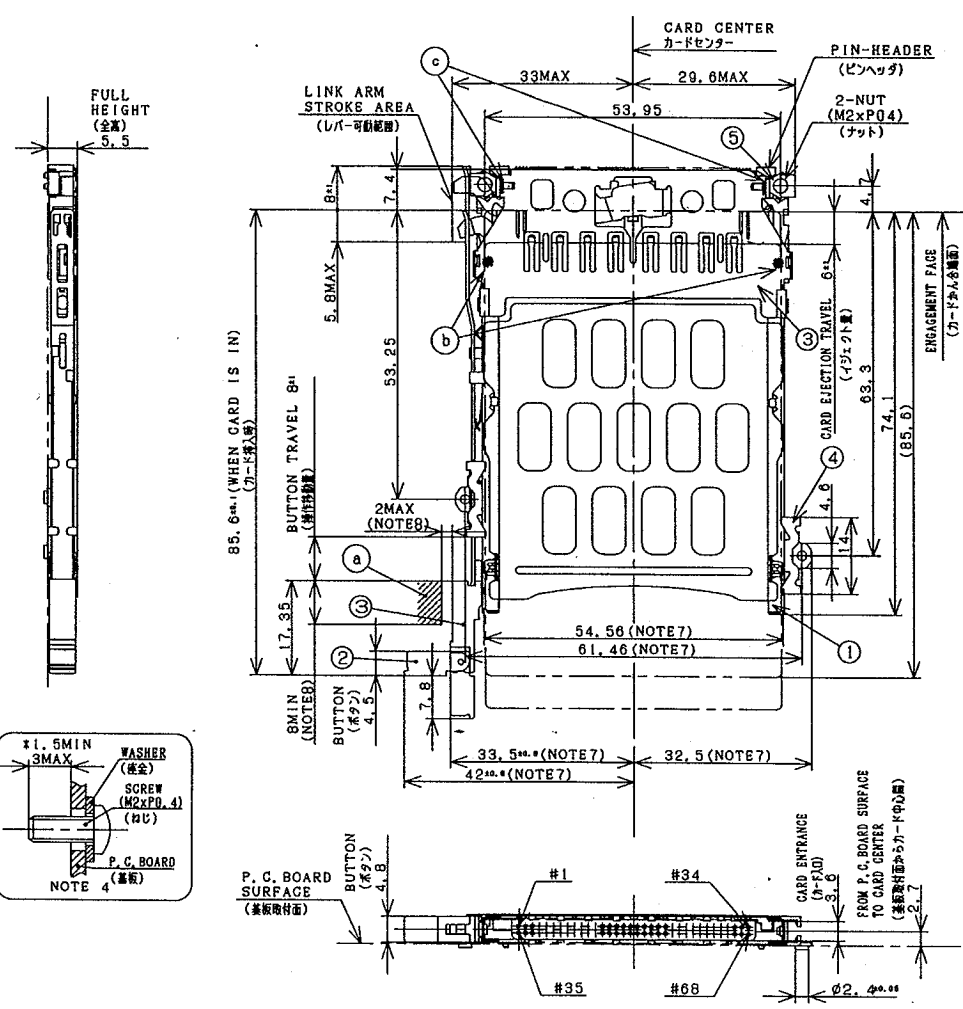

| 許容差の指定なき寸法公差 | | |
|---------------|------|--|
| 10 以下 | ±0.3 | |
| 10 をこえ 100 未満 | ±0.5 | |
| 100 以上 | ±0.8 | |
| 角 度 | ±3° | |

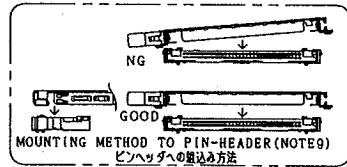
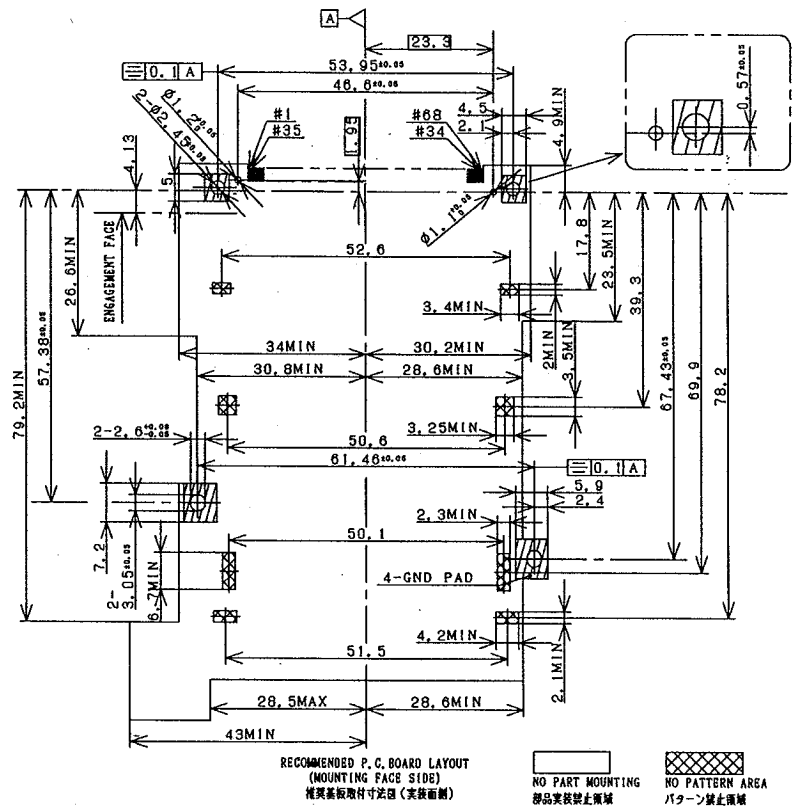

| SHEET INDEX | ISSUE | SH. NO. | TOLERANCES UNLESS OTHERWISE SPECIFIED | MAT | DR | DATE | CUSTOMER COPY |
|-------------|-------|---------|---------------------------------------|----------|-------------|----------|---------------|
| | | | ±0.3 | SEE NOTE | H. Kasugawa | 10/31/01 | |
| | | | | | ENGR | | |
| | | | | | CHK | 10/31/01 | |
| | | | | | APP | 1/5/01 | |

FCI

TITLE: S/D SMIL CARDBUS EJECT MECH FOLDABLE ABOVE MOUNT

SCALE: 3/2 SIZE: C DWG. NO.: 62607 REV: B SHEET: 5 of 5