

SB2020 thru SB20100

Schottky Barrier Rectifiers

Reverse Voltage 35 to 100V Forward Current 20A

Feature & Dimensions

- * Plastic package has underwriters laboratory Flammability classification 94V-0
- * Low power loss,high efficiency
- * For use in low voltage high frequency inverters, free wheeling,and polarity protection applications
- * Guarding for over voltage protection
- * High temperature soldering guaranteed:
260°C/10 seconds at terminals

Mechanical Data

- Case : JEDEC R-6, molded plastic over sky die
- Terminals : Plated axial leads, solderable per MIL-STD-750, Method 2026
- Polarity : Color band denotes cathode end
- Weight : 0.042oz., 1.19 g
- Mounting position : Any
- Handling precautin : None

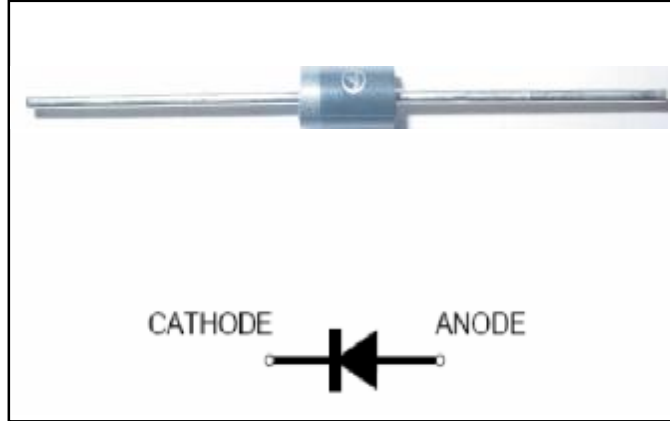

We declare that the material of product compliance with ROHS requirements

1.Maximum & Thermal Characteristics Ratings at 25°C ambient temperature unless otherwise specified.

Parameter symbol	Symbol	SB2035	SB2045	SB2050	SB2060	SB2080	SB20100	Unit
Device marking code		SB2035	SB2045	SB2050	SB2060	SB2080	SB20100	
Maximum repetitive peak reverse voltage	V_{RRM}	35	45	50	60	80	100	V
Maximum RSM voltage	V_{RSM}	35	45	50	60	80	100	V
Maximum DC blocking voltage	V_{DC}	35	45	50	60	80	100	V
Maximum average forward rectified current 0.375" (9.5mm) lead length (See fig. 1)	IF(AV)	20.0						A
Peak forward surge current 8.3ms single half sine-wave superimposed on rated load (JEDEC Method)	I_{FSM1}	230						A
Thermal resistance, junction to ambient	RθJA	40						°C/W
Operating storage temperature range	TJ	-55 to +150						°C
storage temperature range	TSTG	-55 to +175						°C

Electrical Characteristics Ratings at 25°C ambient temperature unless otherwise specified.

Parameter symbol	Symbol	SB2035	SB2045	SB2050	SB2060	SB2080	SB20100	Unit
Maximum instantaneous forward voltage at 20.0A	VF	0.55		0.60	0.70	0.90		V
Maximum DC reverse current TA = 25°C	IR	200						uA
Maximum DC reverse current TA = 100°C	IR	100						mA
Typical junction capacitance at 4.0V, 1MHz	CJ	500			380			PF

Notes:

1. Thermal resistance from junction to ambient at 0.375" (9.5mm) lead length, P.C.B. mounted

SB2020 thru SB20100

2. Characteristic Curves (TA = 25°C unless otherwise noted)

Fig. 1 - Forward Current Derating Curve

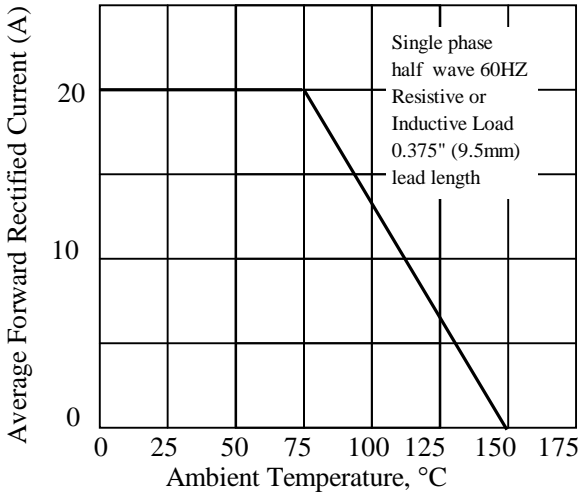

Fig. 2 - Maximum Non-repetitive Peak Forward Surge Current

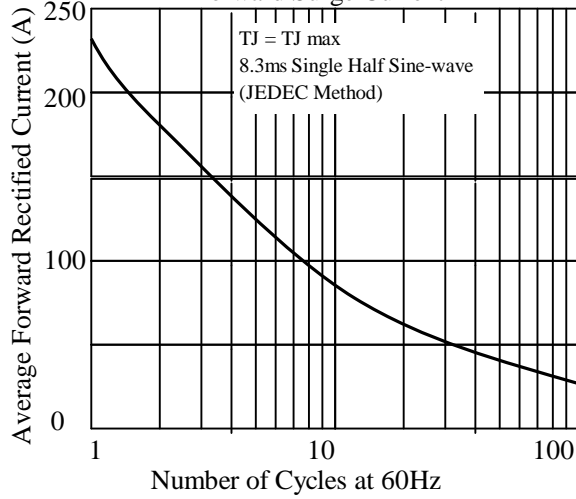

Fig 3. - Typical Instantaneous Forward Characteristics

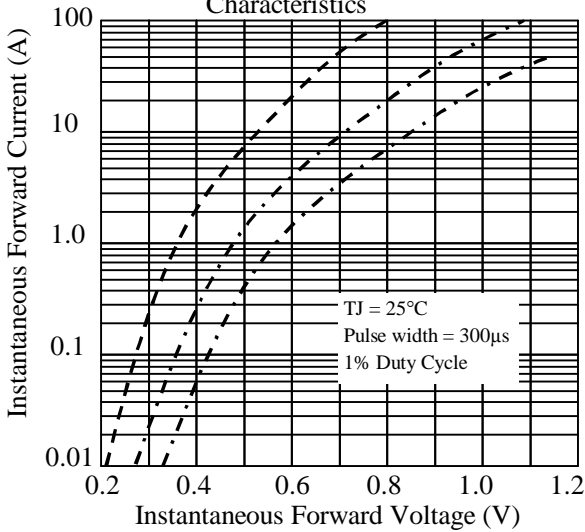

Fig 4. - Typical Reverse Characteristics

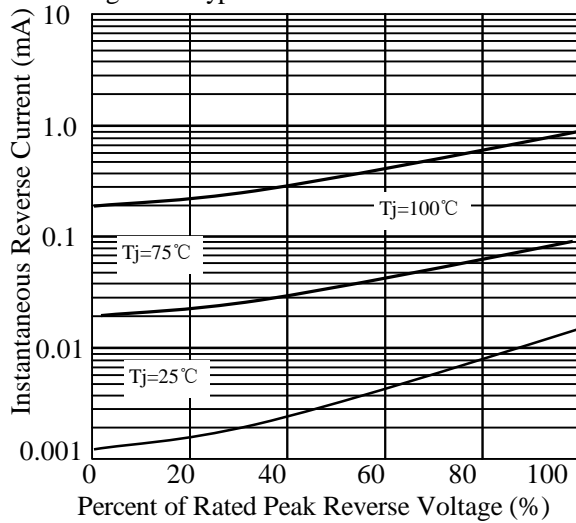

Fig 5. - typical transient thermal impedance

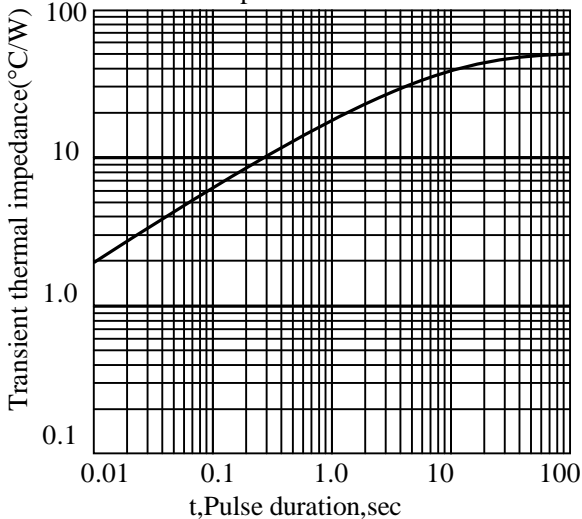
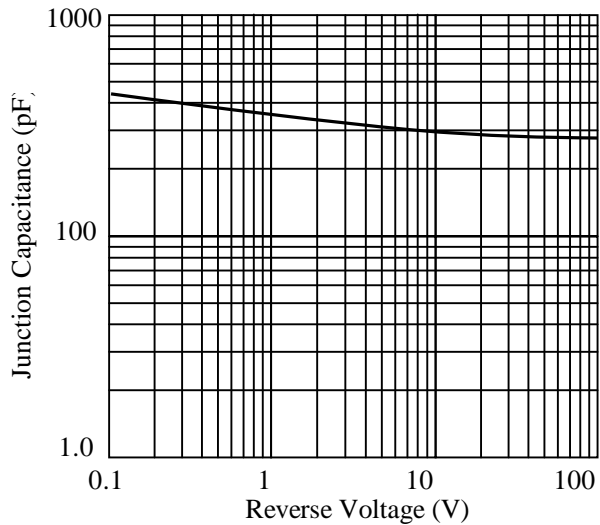
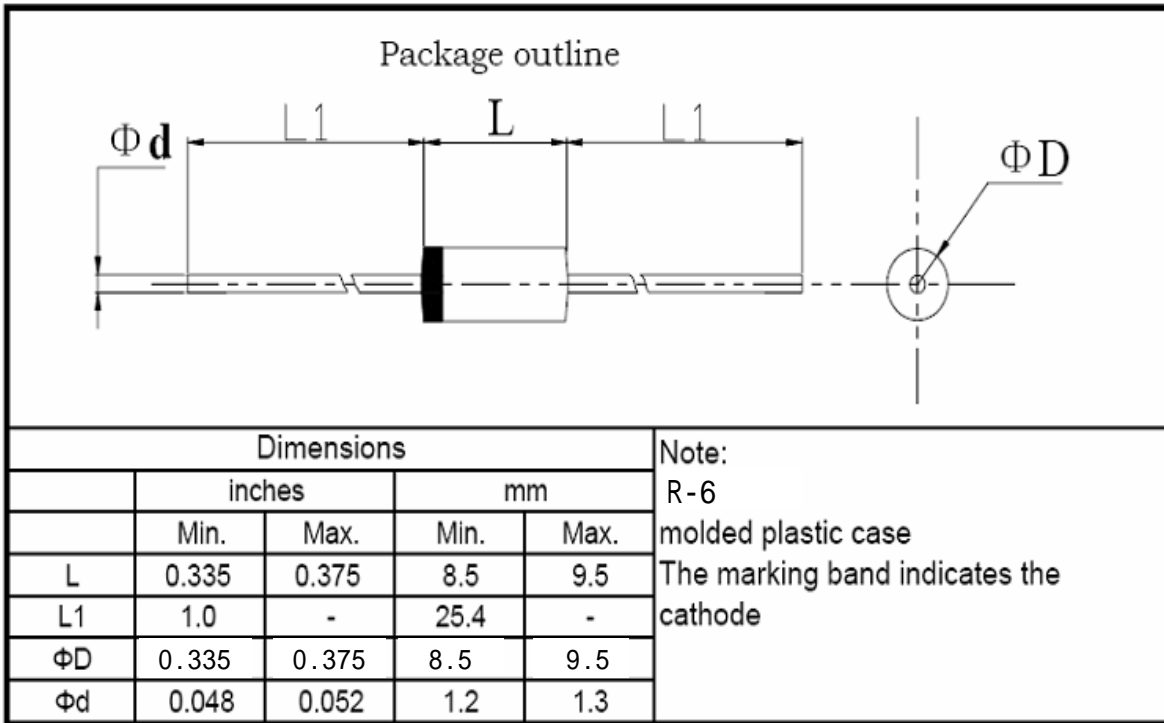

Fig 6. - Typical Junction Capacitance



SB2020 thru SB20100

3. dimension:



标题： 塑封生产线轴向产品包装规范	文件编号： WI-250
	第 4 版 第 0 次修改
	第 1 页

1 弹带盒装 ammo and box

1.1. 弹带盒规格 ammo spec.

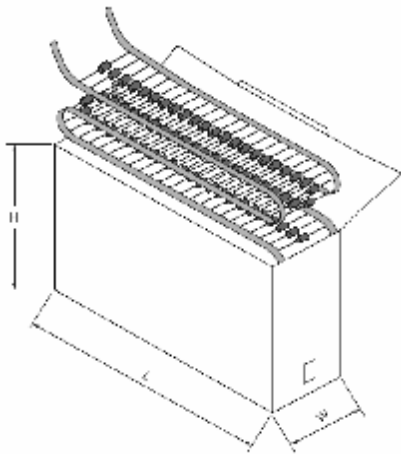

单位：mm

	L	W	H
T52	262±2	76±2	90±2

1.2 弹带内盒要求 inner box spec.

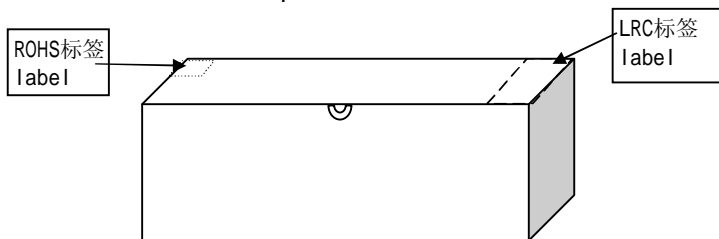

标题: 塑封生产线轴向产品包装规范	文件编号: WI-250
	第 4 版 第 0 次修改
	第 2 页

1.4 标签要求 label spec.

1.4.1 LRC标签 LRC label

成型 FORMING	*****	← 成型规格 forming spec.
型号 TYPE	*****	← LRC产品型号 type
重复峰压 (V) PRV (V)	****	← 产品重复峰压值 peak repetitive voltage
额定电流 (A) I _o (A)	**	← 产品额定电流值 average output current
数量 (只) QTY (pcs)	****	← 产品数量 quantity
检验员 CHECKER	02	
日期: DATE:	*****	← 产品生产日期 date

1.4.2 环保标签 environmental protection label



2. 外箱规格 carton spec.

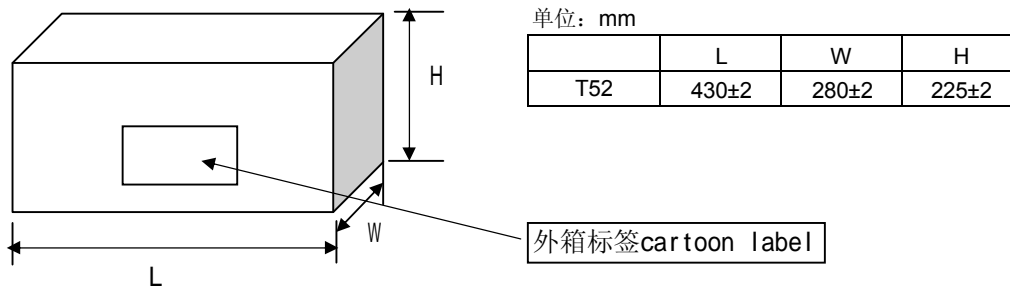

3 按以上包装方式, 编带数量和外包装箱产品数量: typing and carton spec.

	塑封外型
	R-6
每根编带数量 quantity/ammo	0.4K
外箱数量 (T52编带) quantity/cartoon	4.0K

标题:

塑封生产线轴向产品包装规范

文件编号: WI-250

第 4 版 第 0 次修改

第 3 页

4 编带规格 brede spec



尺寸代号	编带尺寸 typing dimension
	52/tape#
W	52 -1.0/+2.0
P	20±0.5
L1-L2	<1.2
H	6±1.0
Z	<1.0
R	<1.0
T	>3.5

1. 红白编带厚度为0.05mm；两种胶带各自之间无明显色差；编带要求均为胶带。
The typing thickness is 0.05mm and color is obvious difference
2. 两端引带20~40cm. Typing lead over 20~40cm
3. 红色编带一端为二极管“负极”；白色编带一端为二极管“正极”。
red color is cathode ,white color is anode
4. 无卤 green epoxy compound (无卤产品才贴HF only)

Green

SB2020 thru SB20100

4. Update Record

版次	更新记录	更新作者	更新日期
1	第一版	周杰	2010-7-30
2	调整存储温度	周杰	2010-9-28