

SPECIFICATIONS

Mechanical

Contact Retention Force: 1.36Kgf min.

Electrical

Voltage Rating: 250V

Current Rating: 2.0A per pin

Dielectric Withstanding Voltage: 1000V AC

Insulation Resistance: 1000MΩ min.

Physical

Housing: Thermoplastic, UL 94V-0 Rating

Contact: Copper alloy

Plating: See "ORDERING INFORMATION"

Operating Temperature: -55 to +105

Header Connector

HL21 Series

Vertical, T/H Type

Plug

2.54mm [.100"] Pitch

10Pos.

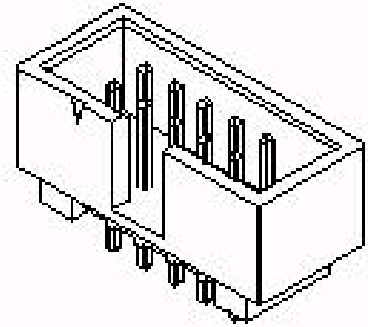

DRAWING

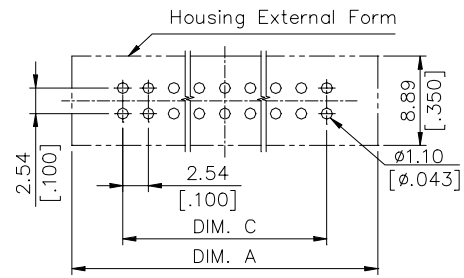
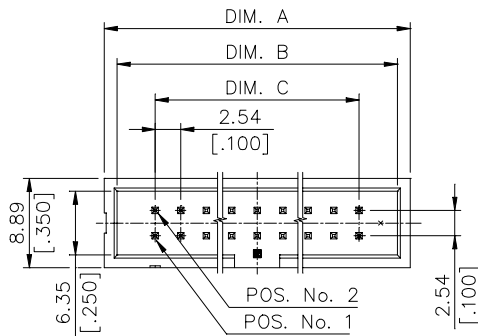

RECOMMENDED P.C.B. LAYOUT

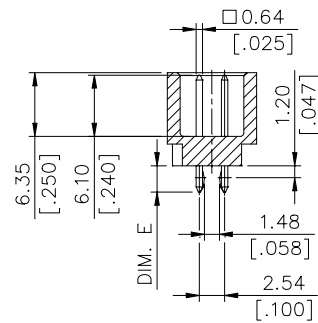
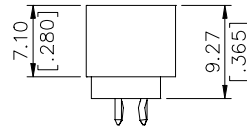
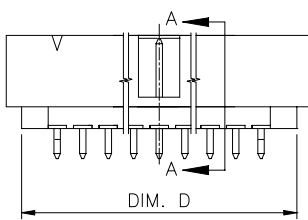

SEC A-A

ORDERING INFORMATION

See The Attachment I

See The Attachment II

The Attachment I

PRODUCT No. : H L 2 1 ** * - * *****

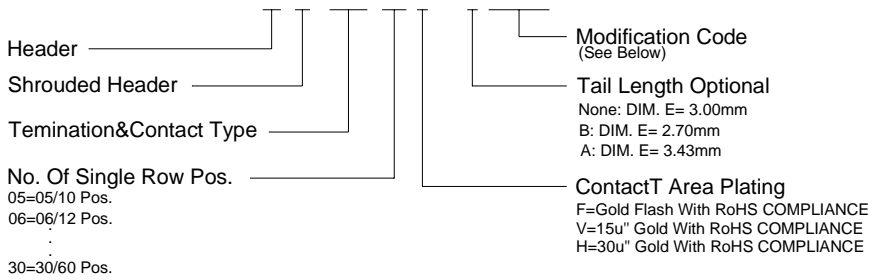

Modification Code

CODE	REMOVED PINS	CODE	REMOVED PINS	CODE	REMOVED PINS	CODE	REMOVED PINS
NONE	FULL PIN	NONE	FULL PIN	NONE	FULL PIN	NONE	FULL PIN
D0	POS. NO. 1	E5	POS. NO. 9 & 10	L6	POS. NO. 14	T9	POS. NO. 25, 27 & 28
D1	LAST PIN	P0	POS. NO. 4	L7	POS. NO. 16	U0	POS. NO. 3, 5, 7 & 9
D2	POS. NO. 20	P1	POS. NO. 6	L8	POS. NO. 1,2,3,4,14,15&16	U1	POS. NO. 3 & 5
D3	POS. NO. 21	P3	POS. NO. 7	L9	POS. NO. 25	U2	POS. NO. 11
D4	POS. NO. 8	P4	POS. NO. 5	T0	POS. NO. 1,2,10,11&12	U3	POS. NO. 19
D6	POS. NO. 25	P5	POS. NO. 10	T1	POS. NO. 7 & 8	U4	POS. NO. 13
D7	POS. NO. 26	P6	POS. NO. 2	T2	POS. NO. 3, 25 & 26	U5	POS. NO. 13,15 & 16
D8	POS. NO. 28	P7	POS. NO. 3	T3	POS. NO. 8 & N	U6	POS. NO. 4 & 7
D9	POS. NO. 15	P8	POS. NO. 17	T4	POS. NO. 3, 19, 20 & 29	U7	POS. NO. 8 & 13
E1	POS. NO. 24	P9	POS. NO. 9	T5	POS. NO. 8 & 9	U8	POS. NO. 4, 5 & 6
E2	POS. NO. 22	L1	POS. NO. 12	T6	POS. NO. 3 & LAST PIN	U9	POS. NO. 1 & 11
E3	POS. NO. 30	L3	POS. NO. 32	T7	POS. NO. 8 & 19		
E4	POS. NO. 38	L5	POS. NO. 18	T8	POS. NO. 30 & 32		

REMARK:

- (1) NONE: STANDARD PRODUCT
(X): TO BE SPECIFIED ON CORRELATIVE CUSTOMER DRAWING
- (2) NONE: STANDARD PRODUCT (COLOR BLACK)
K: THE FIRST & LAST PAIRS OF TERMINALS ARE DEFORMED WITH KINKS
W: HOUSING COLOR IVORY, PANTONE WARM GRAY 1C
U: HOUSING COLOR BLUE, PANTONE 661C
R: HOUSING COLOR RED, PANTONE 199C
Y: HOUSING COLOR YELLOW, PANTONE 123C
G: HOUSING COLOR GREEN, PANTONE 346U
KW: THE FIRST & LAST PAIRS OF TERMINALS ARE DEFORMED WITH KINKS, HOUSING COLOR IVORY
K3: THE FIRST & LAST PAIRS OF TERMINALS ARE DEFORMED WITH KINKS (SPECIAL MODIFICATION CODE)
- (3) FOR REMOVED PIN(S) LOCATED AT FIRST OR LAST PAIR, KINKED POSITION(S) SHOULD BE CHANGED TO THE NEAREST PAIR.

The Attachment II

HL2130*~*****	60	83.82 [3.300]	81.28 [3.300]	73.66 [2.900]	80.77 [3.180]
HL2125*~*****	50	71.12 [2.800]	68.58 [2.700]	60.96 [2.400]	68.07 [2.680]
HL2122*~*****	44	63.5 [2.500]	60.96 [2.400]	53.34 [2.100]	60.45 [2.380]
HL2121*~*****	42	60.96 [2.400]	58.42 [2.300]	50.80 [2.000]	57.91 [2.280]
HL2120*~*****	40	58.42 [2.300]	55.88 [2.200]	48.26 [1.900]	55.37 [2.180]
HL2117*~*****	34	50.80 [2.000]	48.26 [1.900]	40.64 [1.600]	47.75 [1.880]
HL2115*~*****	30	45.72 [1.800]	43.18 [1.700]	35.56 [1.400]	42.67 [1.680]
HL2114*~*****	28	43.18 [1.700]	40.64 [1.600]	33.02 [1.300]	40.13 [1.580]
HL2113*~*****	26	40.64 [1.600]	38.10 [1.500]	30.48 [1.200]	37.59 [1.480]
HL2112*~*****	24	38.10 [1.500]	35.56 [1.400]	27.94 [1.100]	35.05 [1.380]
HL2110*~*****	20	33.02 [1.300]	30.48 [1.200]	22.86 [.900]	29.97 [1.180]
HL2109*~*****	18	30.48 [1.200]	27.94 [1.100]	20.32 [.900]	27.43 [1.080]
HL2108*~*****	16	27.94 [1.100]	25.40 [1.000]	17.78 [.700]	24.89 [.980]
HL2107*~*****	14	25.40 [1.000]	22.86 [.900]	15.24 [.600]	22.35 [.880]
HL2106*~*****	12	22.86 [.900]	20.32 [.800]	12.70 [.500]	19.81 [.780]
HL2105*~*****	10	20.32 [.800]	17.78 [.700]	10.16 [.400]	17.27 [.680]
P/N	POS.	DIM. A	DIM. B	DIM. C	DIM. D