

3-641215-5 ✓ ACTIVE

MTA 100

TE Internal #: 3-641215-5

PCB Mount Header, Vertical, Wire-to-Board, 5 Position, 2.54 mm [.1 in] Centerline, Partially Shrouded, Gold, Through Hole - Solder, Signal, MTA 100

[View on TE.com >](#)



Connectors > PCB Connectors > PCB Headers & Receptacles > PCB Header: Polyester, Vertical, Unshrouded, No Mating Alignment

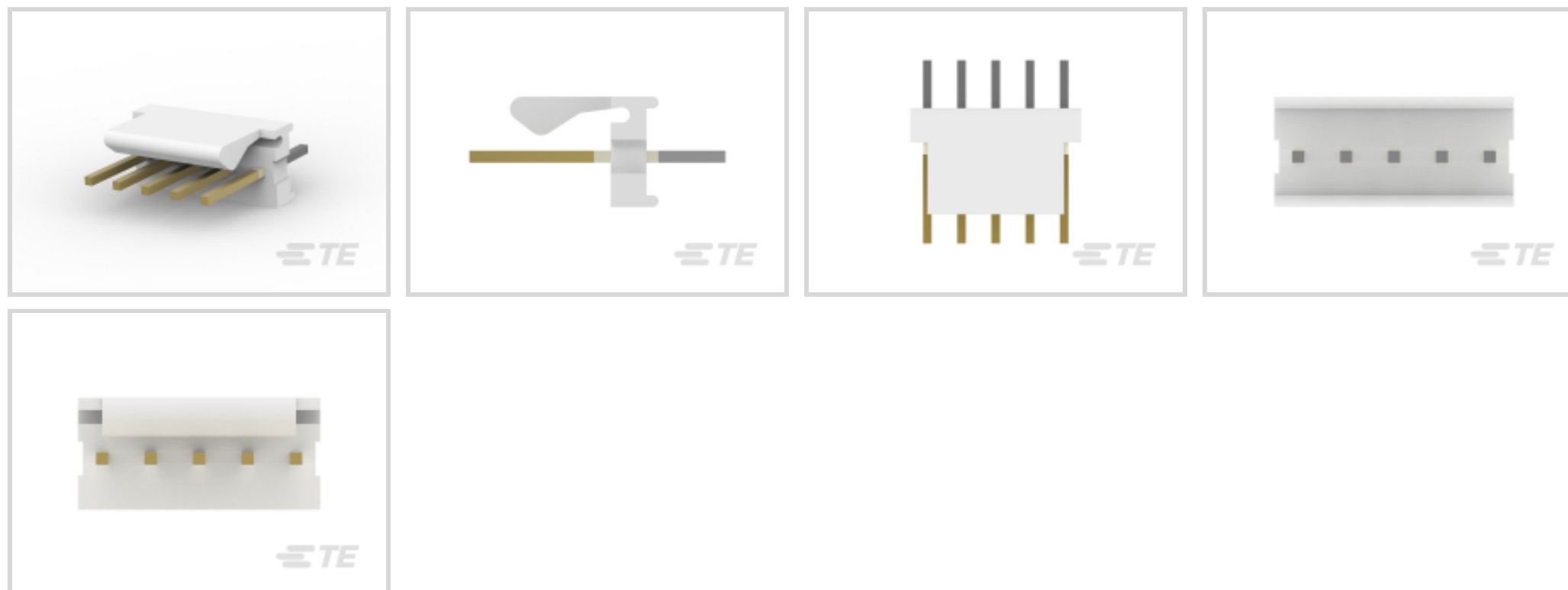

Connector System: **Wire-to-Board**

Number of Positions: **5**

Number of Rows: **1**

Centerline (Pitch): **2.54 mm [.1 in]**

PCB Mount Orientation: **Vertical**

[All PCB Header: Polyester, Vertical, Unshrouded, No Mating Alignment \(134\)](#)

Features

Product Type Features

Connector System	Wire-to-Board
Header Type	Partially Shrouded
Sealable	No
Connector & Contact Terminates To	Printed Circuit Board
PCB Connector Assembly Type	PCB Mount Header

Configuration Features

Number of Positions	5
Number of Rows	1
PCB Mount Orientation	Vertical

Electrical Characteristics

Operating Voltage	250 VAC
-------------------	---------

Body Features



Primary Product Color	Natural
-----------------------	---------

Contact Features

Contact Mating Area Length	7.49 mm[.295 in]
----------------------------	------------------

Mating Square Post Dimension	.64 mm[.025 in]
------------------------------	-----------------

PCB Contact Termination Area Plating Material Thickness	3.81 – 8.89 μm [150 – 350 μin]
---	---

Contact Layout	Inline
----------------	--------

Contact Underplating Material Thickness	1.27 μm [50 μin]
---	---

Contact Mating Area Plating Material Thickness	.76 μm [29.92 μin]
--	---

PCB Contact Termination Area Plating Material Finish	Matte
--	-------

Contact Shape & Form	Square
----------------------	--------

Contact Mating Area Plating Material Finish	Bright
---	--------

Contact Underplating Material	Nickel
-------------------------------	--------

PCB Contact Termination Area Plating Material	Tin
---	-----

Contact Base Material	Copper Alloy
-----------------------	--------------

Contact Mating Area Plating Material	Gold
--------------------------------------	------

Contact Type	Pin
--------------	-----

Contact Current Rating (Max)	5 A
------------------------------	-----

Termination Features

Square Termination Post & Tail Dimension	.64 mm[.025 in]
--	-----------------

Termination Post & Tail Length	3.56 mm[.14 in]
--------------------------------	-----------------

Termination Method to Printed Circuit Board	Through Hole - Solder
---	-----------------------

Mechanical Attachment

Mating Alignment Type	Polarization
-----------------------	--------------

Mating Retention	With
------------------	------

Panel Mount Feature	Without
---------------------	---------

Mating Retention Type	Friction Lock
-----------------------	---------------

Connector Mounting Type	Cable Mount (Free-Hanging)
-------------------------	----------------------------

Mating Alignment	With
------------------	------

PCB Mount Alignment	Without
---------------------	---------

PCB Mount Retention	Without
---------------------	---------

Housing Features

Housing Material	Polyester - GF
------------------	----------------

Centerline (Pitch)	2.54 mm[.1 in]
--------------------	----------------



Dimensions

Connector Length	15.24 mm[.6 in]
Connector Height	7.87 mm[.31 in]
PCB Thickness (Recommended)	1.6 mm[.063 in]

Usage Conditions

Operating Temperature Range	-55 – 105 °C[-67 – 221 °F]
-----------------------------	----------------------------

Operation/Application

Circuit Application	Signal
---------------------	--------

Industry Standards

Agency/Standard	CSA, UL
Approved Standards	CSA LR7189, UL E28476
UL Flammability Rating	UL 94V-0

Packaging Features

Packaging Quantity	1
Packaging Type	Package

Product Compliance

[For compliance documentation, visit the product page on TE.com>](#)

EU RoHS Directive 2011/65/EU	Compliant
EU ELV Directive 2000/53/EC	Compliant
China RoHS 2 Directive MIIT Order No 32, 2016	No Restricted Materials Above Threshold
EU REACH Regulation (EC) No. 1907/2006	Current ECHA Candidate List: JUNE 2023 (235) Candidate List Declared Against: JUNE 2023 (235) Does not contain REACH SVHC
Halogen Content	Not Low Halogen - contains Br or Cl > 900 ppm.
Solder Process Capability	Wave solder capable to 265°C

Product Compliance Disclaimer

This information is provided based on reasonable inquiry of our suppliers and represents our current actual knowledge based on the information they provided. This information is subject to change. The part numbers that TE has identified as EU RoHS compliant have a maximum concentration of 0.1% by weight in homogenous materials for lead, hexavalent chromium, mercury, PBB, PBDE, DBP, BBP, DEHP, DIBP, and 0.01% for cadmium, or qualify for an exemption to these limits as defined in the Annexes of Directive 2011/65/EU (RoHS2). Finished electrical and electronic equipment products will be CE marked as required by Directive 2011/65/EU. Components may not be CE marked. Additionally, the part

numbers that TE has identified as EU ELV compliant have a maximum concentration of 0.1% by weight in homogenous materials for lead, hexavalent chromium, and mercury, and 0.01% for cadmium, or qualify for an exemption to these limits as defined in the Annexes of Directive 2000/53/EC (ELV). Regarding the REACH Regulation, the information TE provides on SVHC in articles for this part number is based on the latest European Chemicals Agency (ECHA) 'Guidance on requirements for substances in articles' posted at this URL: <https://echa.europa.eu/guidance-documents/guidance-on-reach>

Compatible Parts



TE Part # CAT-104MTA-NGPNR
Nylon Gold Plated Receptacle: 2.54 mm, no Mating Alignment



TE Part # CAT-104MTA-PLSCC
Polyester PCB Connector Covers: 2.54 mm, MTA 100



TE Part # 1375820-5
CST-100 II HOUSING 5 POS



TE Part # CAT-104MTA-NGPMR
Nylon Gold Plated Receptacle: 2.54 mm, with Mating Alignment, MTA 100



TE Part # CAT-104MTA-NYLCC
Nylon PCB Connector Covers: 2.54 mm, MTA 100



TE Part # 3-643787-3
05P MTA100 HDR ASSY F/L W/O#2

Also in the Series | MTA 100



Connector Caps & Covers(69)



Connector Hardware(1)



Insertion & Extraction Tools(2)



PCB Headers & Receptacles(440)



Standard Rectangular Connectors(495)



Wire-to-Board Connector Assemblies & Housings(1)



Wire-to-Board Connector Contacts(8)

Customers Also Bought



TE Part #3-641215-6
PCB Header: Polyester, Vertical,
Unshrouded, No Mating Alignment



TE Part #5-640441-4
24P MTA100 CONN ASSY WHT



TE Part #3-641238-5
Nylon Gold Plated Receptacle: 2.54
mm, no Mating Alignment



TE Part #3-641119-7
07P MTA156 HDR ASSY FL/ST LF

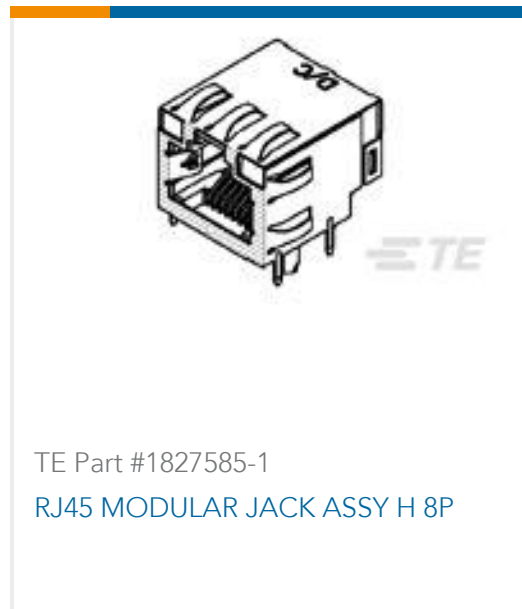

TE Part #1827585-1
RJ45 MODULAR JACK ASSY H 8P



TE Part #4-1437514-3
322-HCS6P2-100=HOLT CNT SKT RE

Documents

Product Drawings

[05P MTA100 HDR ASSY FL 30AU LF](#)

English

CAD Files

[3D PDF](#)

3D

Customer View Model

[ENG_CVM_CVM_3-641215-5_Z.2d_dxf.zip](#)

English

Customer View Model

[ENG_CVM_CVM_3-641215-5_Z.3d_igs.zip](#)

English

Customer View Model

[ENG_CVM_CVM_3-641215-5_Z.3d_stp.zip](#)

English

By downloading the CAD file I accept and agree to the [Terms and Conditions](#) of use.

Product Specifications

[Application Specification](#)

English

Product Environmental Compliance

[MD_3-641215-5_08012016101_dmtec](#)

English

[MD_3-641215-5_08012016101_dmtec](#)

English

3-641215-5

PCB Mount Header, Vertical, Wire-to-Board, 5 Position, 2.54 mm [.1 in] Centerline,
Partially Shrouded, Gold, Through Hole - Solder, Signal, MTA 100



[Agency Approvals](#)

[CSA Certificate](#)

English