

Panel Mount Type Cap Housings

(Applicable Contact P/N: 175149-□, 175150-□)

For 2 Circuits

Material:
UL 94V-0 rated, 6/6 Nylon

Part Number: 176292-□

Housing Color
(for suffixed no.)
-1—Natural
-2—Red
-4—Yellow
-6—Blue
-9—Black

Panel Cutout

Dimension tolerance:
 ± 0.13
Panel thickness:
0.8–2.0

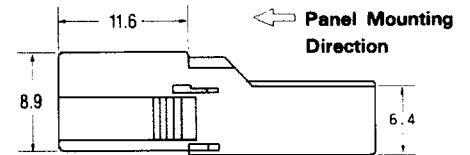
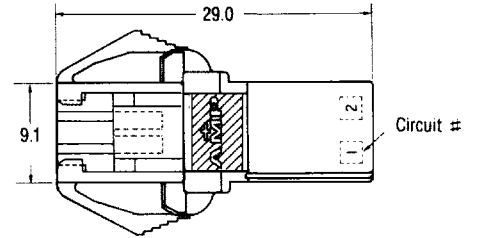
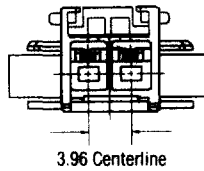
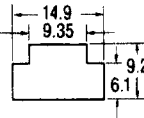

For 3 Circuits

Material:
UL 94V-0 rated, 6/6 Nylon

Part Number: 176293-□

Housing Color
(for suffixed no.)
-1—Natural
-2—Red
-4—Yellow
-6—Blue
-9—Black

Panel Cutout

Dimension tolerance:
 ± 0.13
Panel thickness:
0.8–2.0

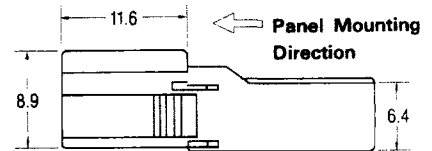
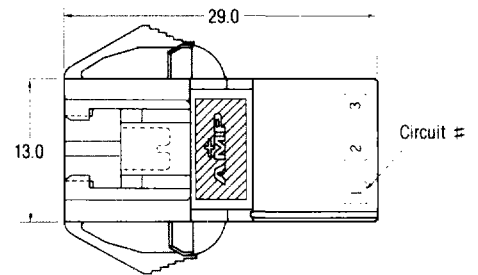
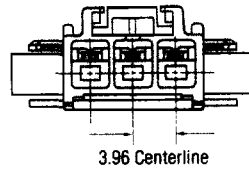
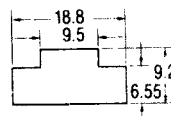

For 4 Circuits

Material:
UL 94V-0 rated, 6/6 Nylon

Part Number: 176294-□

Housing Color
(for suffixed no.)
-1—Natural
-2—Red
-4—Yellow
-6—Blue
-9—Black

Panel Cutout

Dimension tolerance:
 ± 0.13
Panel thickness:
0.8–2.0

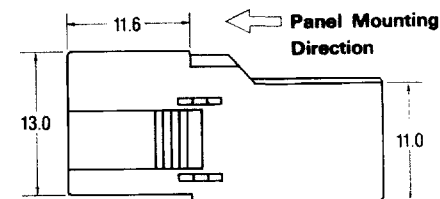
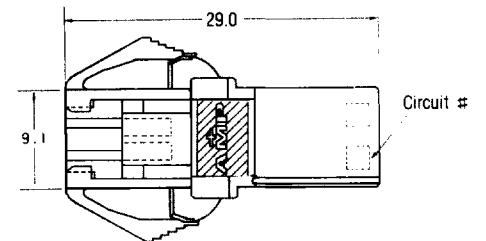
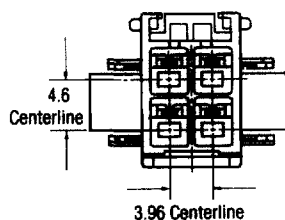
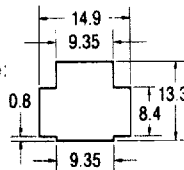

Panel Mount Type Cap Housings (Cont'd)

(Applicable Contact P/N: 175149-□, 175150-□)

For 6 Circuits

Material:

UL 94V-0 rated, 6/6 Nylon

Part Number: 176295-□

Housing Color

(for suffixed no.)

- 1—Natural
- 2—Red
- 4—Yellow
- 6—Blue
- 9—Black

Panel Cutout

Dimension tolerance:

±0.13

Panel thickness:

0.8–2.0

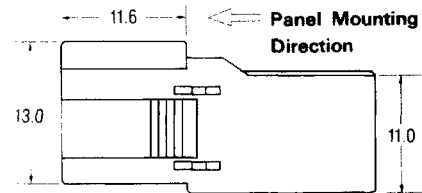
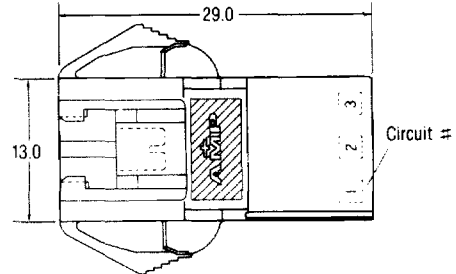
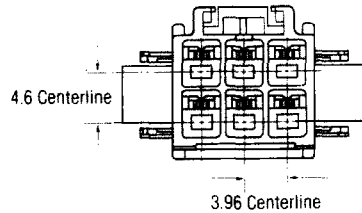
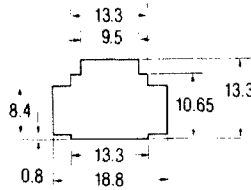

For 8 Circuits

Material:

UL 94V-0 rated, 6/6 Nylon

Part Number: 176296-□

Housing Color

(for suffixed no.)

- 1—Natural
- 2—Red
- 4—Yellow
- 6—Blue
- 9—Black

Panel Cutout

Dimension tolerance:

±0.13

Panel thickness:

0.8–2.0

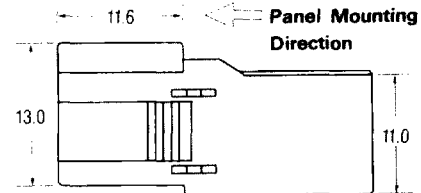
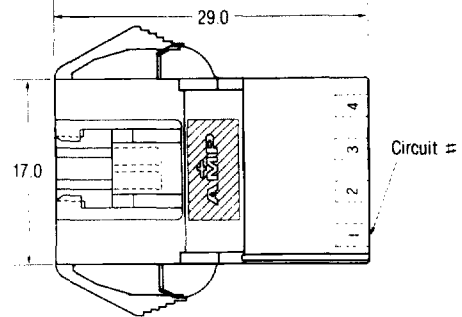
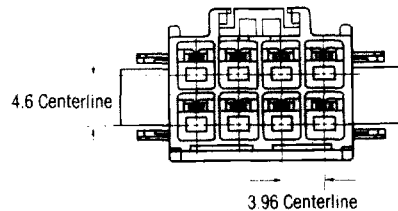
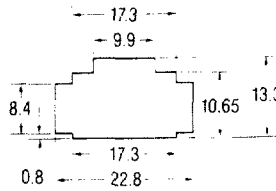

For 9 Circuits

Material:

UL 94V-0 rated, 6/6 Nylon

Part Number: 176297-□

Housing Color

(for suffixed no.)

- 1—Natural
- 2—Red
- 4—Yellow
- 6—Blue
- 9—Black

Panel Cutout

Dimension tolerance:

±0.13

Panel thickness:

0.8–2.0

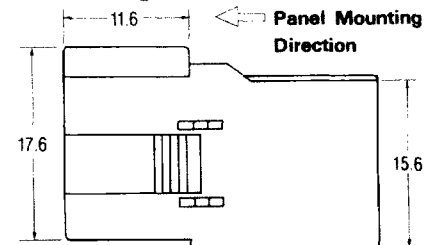
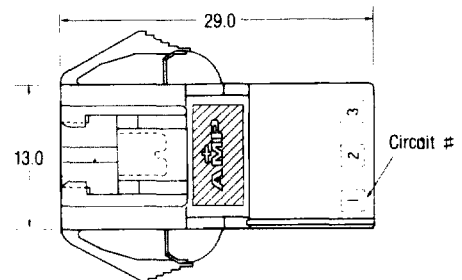
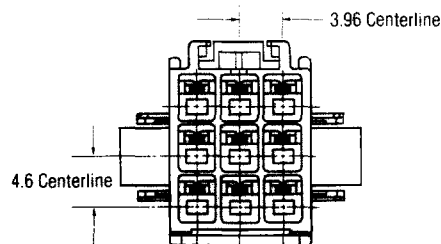
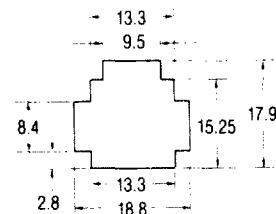

Panel Mount Type Cap Housings (Cont'd)

(Applicable Contact P/N: 175149-□, 175150-□)

For 10 Circuits

Material:
UL 94V-0 rated, 6/6 Nylon

Part Number: 176298-□

Housing Color
(for suffixed no.)

- 1—Natural
- 2—Red
- 4—Yellow
- 6—Blue
- 9—Black

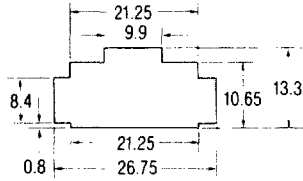

Panel Cutout

Dimension tolerance: ± 0.13
Panel thickness: 0.8–2.0

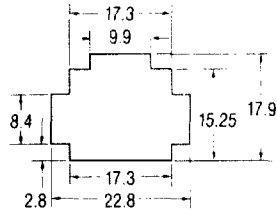
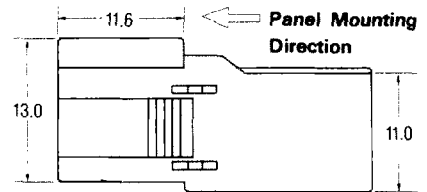
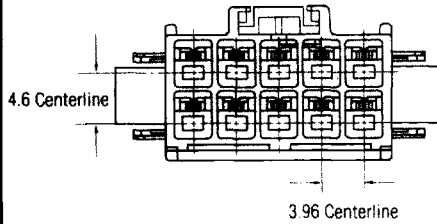
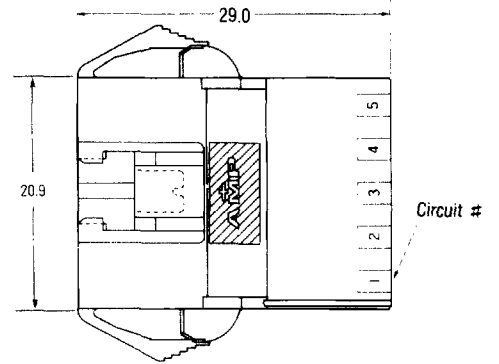

Panel Cutout

Dimension tolerance: ± 0.13
Panel thickness: 0.8–2.0

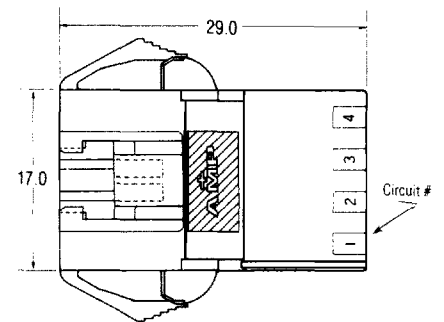

For 12 Circuits

Material:
UL 94V-0 rated, 6/6 Nylon

Part Number: 176299-□

Housing Color
(for suffixed no.)

- 1—Natural
- 2—Red
- 4—Yellow
- 6—Blue
- 9—Black

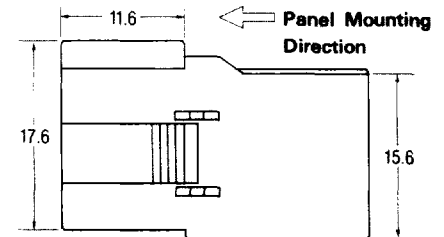
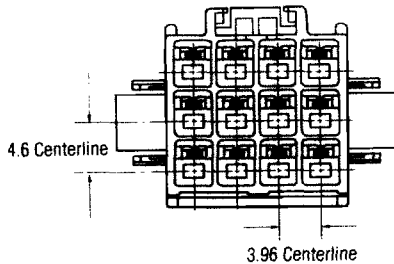

Panel Mount Type Cap Housings (Cont'd)

(Applicable Contact P/N: 175149-□, 175150-□)

For 15 Circuits

Material:

UL 94V-0 rated, 6/6 Nylon

Part Number: 176300-□

Housing Color
(for suffixed no.)

- 1—Natural
- 2—Red
- 4—Yellow
- 6—Blue
- 9—Black

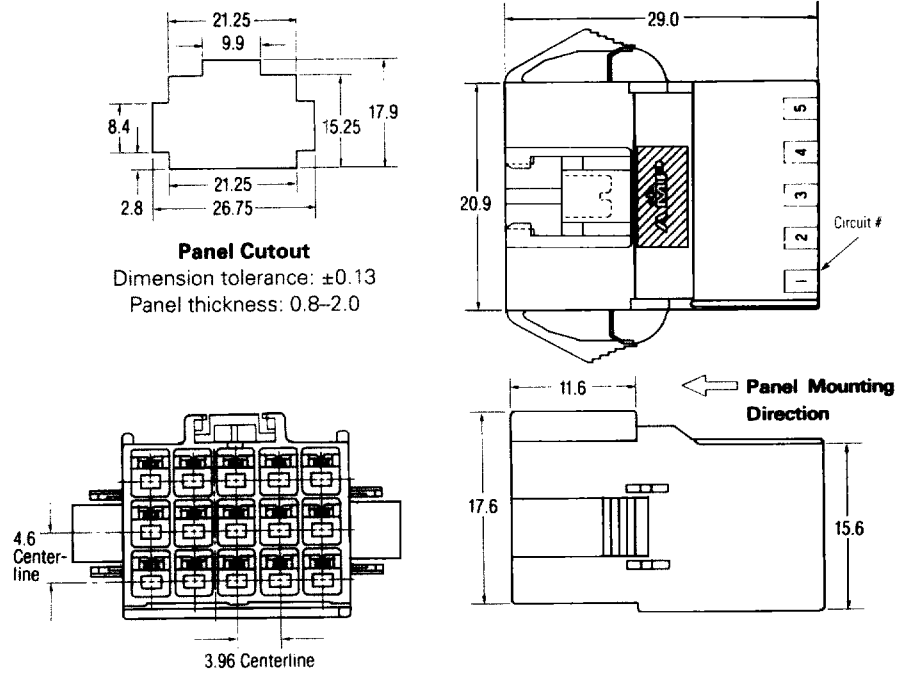

For 18 Circuits

Material:

UL 94V-0 rated, 6/6 Nylon

Part Number: 176301-□

Housing Color
(for suffixed no.)

- 1—Natural
- 2—Red
- 4—Yellow
- 6—Blue
- 9—Black

