

## PNP SILICON PLANAR EPITAXIAL TRANSISTORS

**BC856**  
**BC857**  
**BC858**



**SOT-23**

**SOT-23**  
**SMD Package**  
**RoHS compliant**

### FEATURES:

1. Device Marking

- BC856 =3D
- BC856A=3A
- BC856B=3B
- BC857 =3H
- BC857A=3E
- BC857B=3F
- BC857C=3G
- BC858 =3M
- BC858A=3J
- BC858B=3K
- BC858C=3L

2. This product is available in AEC-Q101 Compliant and PPAP Capable also.

**Note:** For AEC-Q101 compliant products, please use suffix -AQ in the part number while ordering.

### ABSOLUTE MAXIMUM RATING (Ta = 25 °C Unless otherwise specified)

PARAMETER	SYMBOL	BC856	BC857	BC858	UNIT
Collector Base Voltage	$V_{CBO}$	80	50	30	V
Collector Emitter Voltage	$V_{CEO}$	65	45	30	V
Emitter Base Voltage	$V_{EBO}$	5			V
Collector Current (DC)	$I_C$	100			mA
Collector Current - Peak	$I_{CM}$	200			mA
Power Dissipation	$P_{tot}$	200			mW
Storage Temperature	$T_{stg}$	-65 to +150			°C
Junction Temperature	$T_j$	150			°C

**ELECTRICAL CHARACTERISTICS at** (Ta = 25 °C Unless otherwise specified)

PARAMETER	SYMBOL	TEST CONDITION	MIN	TYP	MAX	UNIT	
DC Current Gain	$h_{FE}$	$I_C=2mA, V_{CE}=5V$	A	125	--	250	
			B	220	--	475	
			C	420	--	800	
Collector Cut off Current	$I_{CBO}$	$V_{CB}=30V, I_E=0$	--	--	15	nA	
Collector Base Voltage	$V_{CBO}$	$I_C=10m A, I_E=0$	BC856	80	--	--	V
			BC857	50	--	--	V
			BC858	30	--	--	V
Collector Emitter Voltage	$V_{CES}$	$I_C=10m A, V_{BE}=0$	BC856	80	--	--	V
			BC857	50	--	--	V
			BC858	30	--	--	V
Collector Emitter Voltage	$V_{CEO}$	$I_C=1mA, I_B=0$	BC856	65	--	--	V
			BC857	45	--	--	V
			BC858	30	--	--	V
Emitter Base Voltage	$V_{EBO}$	$I_E=1m A, I_C=0$	5	--	--	V	
Collector Emitter Saturation Voltage	$V_{CE(Sat)}$	$I_C=10mA, I_B=0.5mA$	--	--	0.30	V	
		$I_C=100mA, I_B=5mA$	--	--	0.65	V	
Base Emitter on Voltage	$V_{BE(on)}$	$I_C=2mA, V_{CE}=5V$	0.6	--	0.75	V	
		$I_C=10mA, V_{CE}=5V$	--	--	0.82	V	
Transition Frequency	$f_T$	$I_C=10mA, V_{CE}=5V, f=100MHz$	100	--	--	MHz	
Output Capacitance	$C_{ob}$	$V_{CB}=10V, f=1MHz$	--	--	6.0	pF	
Noise Figure	NF	$I_C=0.2mA, V_{CE}=5V, R_s=2kW, f=1KHz$	--	--	10	dB	

**Note:**

1. For PNP device voltage and current values will be negative (-).

### Recommended Reflow Solder Profiles

The recommended reflow solder profiles for Pb and Pb-free devices are shown below.

Figure 1 shows the recommended solder profile for devices that have Pb-free terminal plating, and where a Pb-free solder is used.

Figure 2 shows the recommended solder profile for devices with Pb-free terminal plating used with leaded solder, or for devices with leaded terminal plating used with a leaded solder.

Figure 1

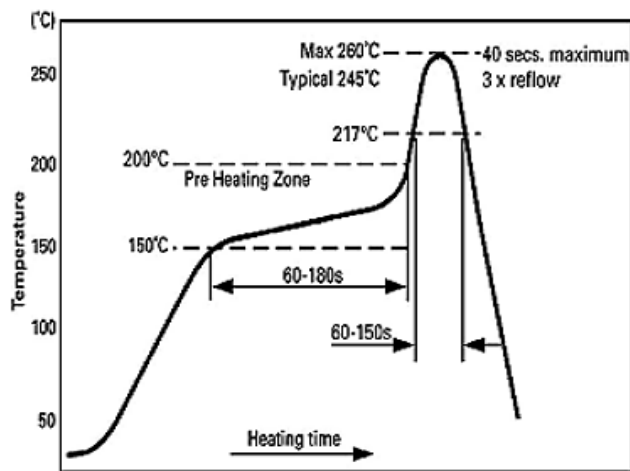
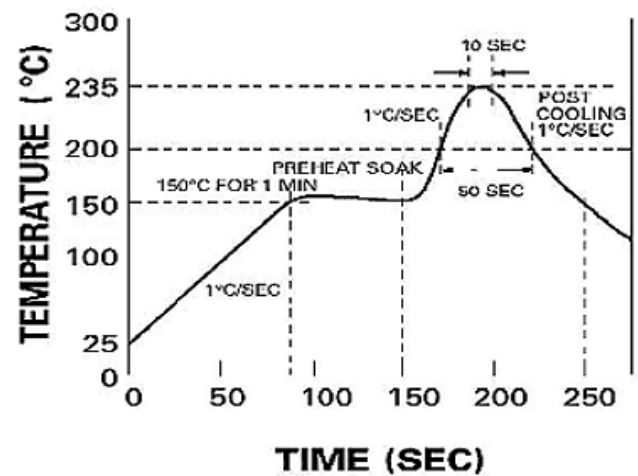

Figure 2



#### Reflow profiles in tabular form

Profile Feature	Sn-Pb System	Pb-Free System
Average Ramp-Up Rate	~3°C/second	~3°C/second
<b>Preheat</b>		
– Temperature Range	150-170°C	150-200°C
– Time	60-180 seconds	60-180 seconds
Time maintained above:		
– Temperature	200°C	217°C
– Time	30-50 seconds	60-150 seconds
Peak Temperature	235°C	260°C max.
Time within +0 -5°C of actual Peak	10 seconds	40 seconds
Ramp-Down Rate	3°C/second max.	6°C/second max.

### Recommended Wave Solder Profiles

The Recommended solder Profile For Devices with Pb-free terminal plating where a Pb-free solder is used

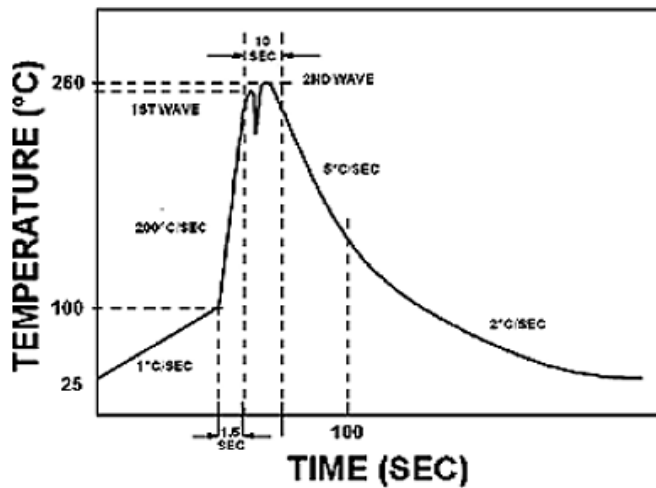

The Recommended solder Profile For Devices with Pb-free terminal plating used with leaded solder, or for devices with leaded terminal plating used with leaded solder

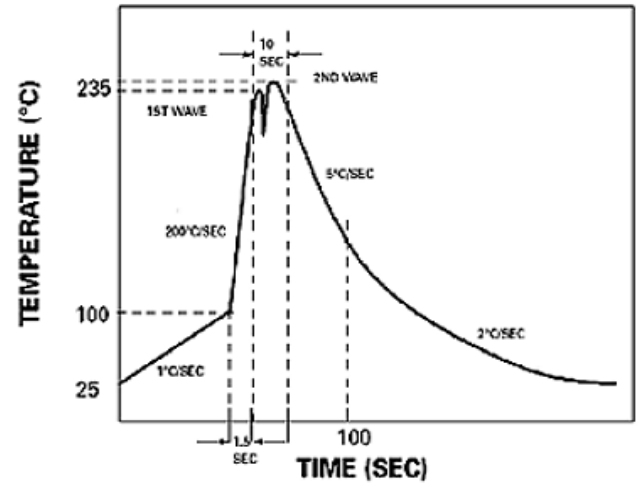

### Wave Profiles in Tabular Form

Profile Feature	Sn-Pb System	Pb-Free System
Average Ramp-Up Rate	~200°C/second	~200°C/second
Heating rate during preheat	Typical 1-2, Max 4°C/sec	Typical 1-2, Max 4°C/Sec
Final preheat Temperature	Within 125°C of Solder Temp	Within 125°C of Solder Temp
Peak Temperature	235°C	260°C max.
Time within +0 -5°C of actual Peak	10 seconds	10 seconds
Ramp-Down Rate	5°C/second max.	5°C/second max

## TYPICAL CHARACTERISTICS CURVES

Fig 1 Static Characteristic

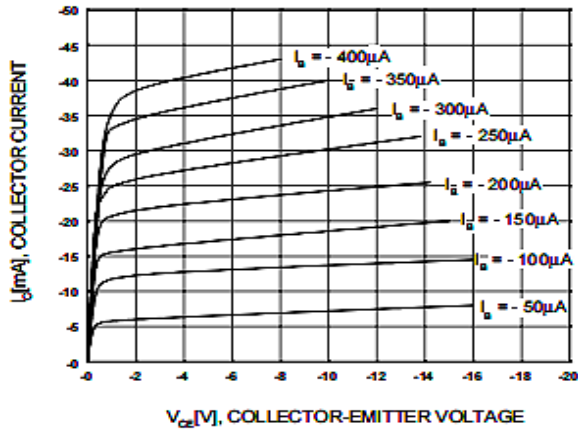

Fig 4: DC current Gain

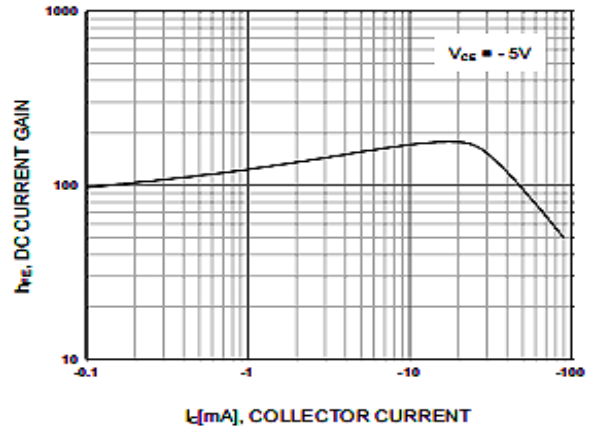

Fig 2: Base-Emitter Saturation Voltage  
Collector-Emmitter Saturation Voltage

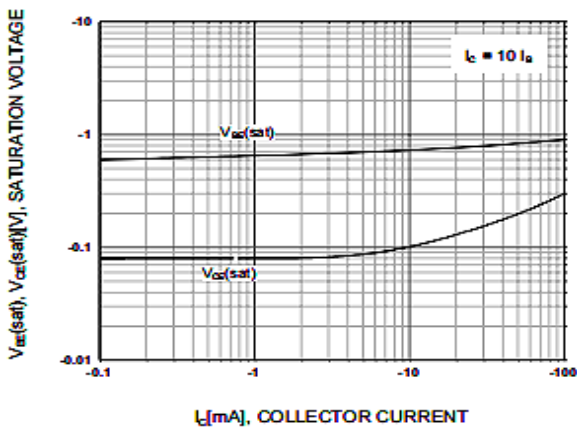

Fig 5: Base-Emitter On Voltage

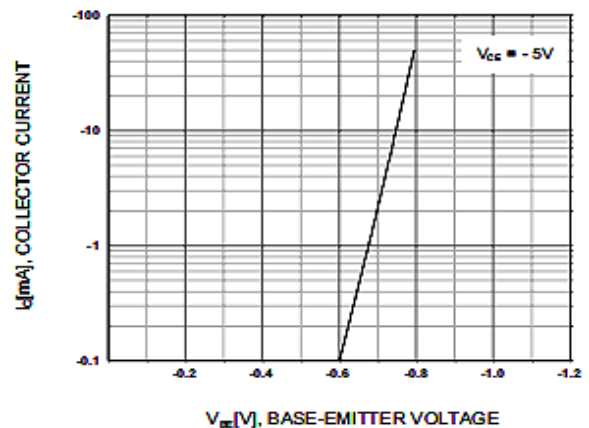

Fig 3: Collector Output Capacitance

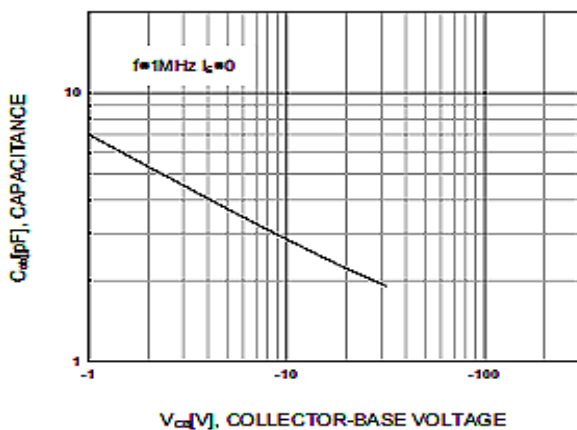
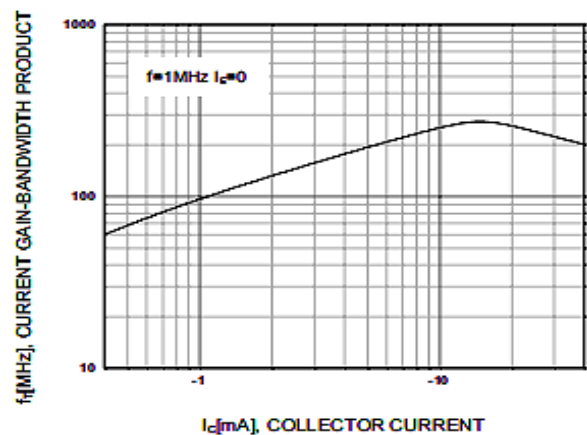
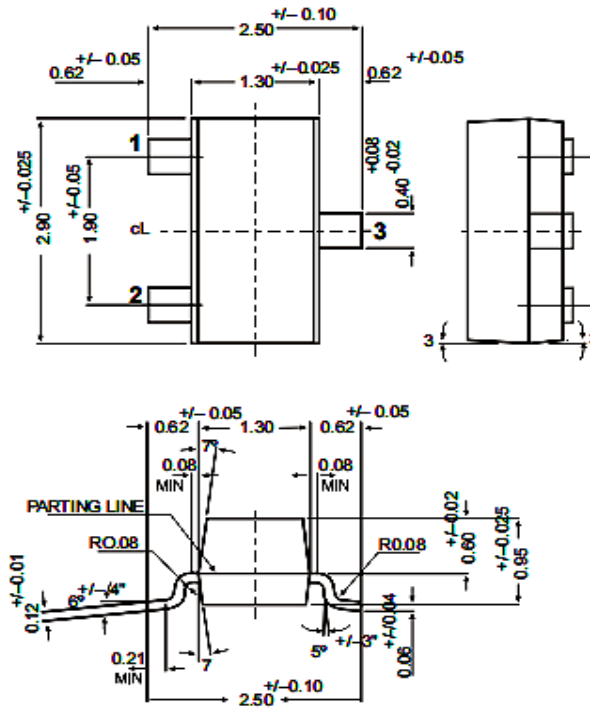

Fig 6: Current Gain Bandwidth Product



## PACKAGE DETAILS

### SOT-23 Leaded Plastic Package



All dimensions are in mm

### Pin Configuration

1. Base
2. Emitter
3. Collector

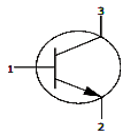

### Recommend PCB solder land [Unit: mm]

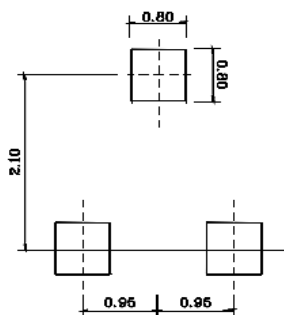

### SOT-23 Package Reel Information Reel specifications for Packing (13"/7" reels)

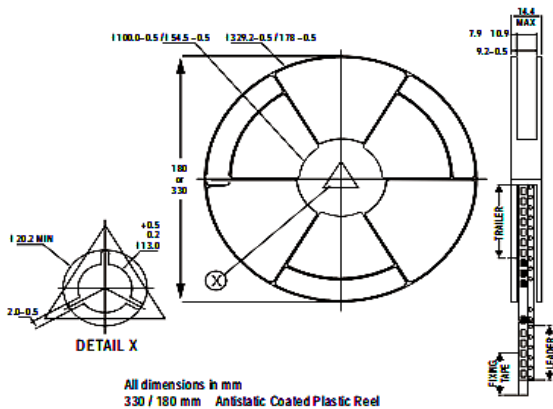

**NOTES:**

Size of Tape	8mm	8mm
Size of reel	330mm (13")	180mm (7")
No. of Device	10,000 Pcs	3,000 Pcs

1. The bandoier of 330mm reel contains at least 10,000 device.
2. The bandoier of 180mm reel contains at least 3,000 device.
3. No more than 0.5% missing device/reel 50 empty compartments for 330mm reel. 15 empty compartments for 180mm reel.
4. Three consecutive empty places might be found provided this gap is followed by 6 consecutive devices.
5. The carrier tape (leader) starts with at least 75 empty positions (equivalent to 330 mm). In order to fix the carrier tape a self adhesive tape of 20 to 50 mm is applied. At the end of the bandolier at least 40 empty positions (equivalent to 160 mm) are there.

### Tape Specification for SOT-23 Surface Mount Device

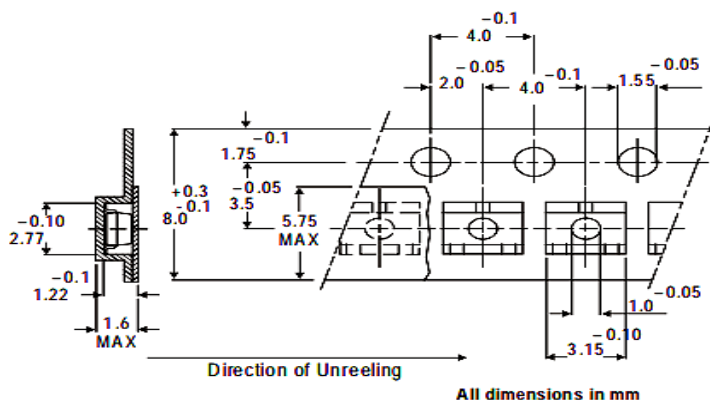

### Packing Detail

PACKAGE	STANDARD PACK		INNER CARTON BOX		OUTER CARTON BOX		
	Details	Net Weight/Qty	Size	Qty	Size	Qty	Gr Wt
SOT-23 T&R	3K/reel	136 gm/3K pcs	3" x 7.5" x 7.5"	12.0K	17" x 15" x 13.5"	192.0K	12 kgs
	10K/reel	415 gm/10K pcs	9" x 9" x 9"	51.0K	19" x 19" x 19"	408.0K	28 kgs
			13" x 13" x 0.5"	10.0K	17" x 15" x 13.5"	300.0K	16 kgs



Continental Device India Pvt. Limited

An IATF 16949, ISO9001 and ISO 14001 Certified Company



### Recommended Product Storage Environment for Discrete Semiconductor Devices

This storage environment assumes that the Diodes and transistors are packed properly inside the original packing supplied by CDIL.

- Temperature 5 °C to 30 °C
- Humidity between 40 to 70 %RH
- Air should be clean.
- Avoid harmful gas or dust.
- Avoid outdoor exposure or storage in areas subject to rain or water spraying .
- Avoid storage in areas subject to corrosive gas or dust. Product shall not be stored in areas exposed to direct sunlight.
- Avoid rapid change of temperature.
- Avoid condensation.
- Mechanical stress such as vibration and impact shall be avoided.
- The product shall not be placed directly on the floor.
- The product shall be stored on a plane area. They should not be turned upside down. They should not be placed against the wall.

#### **Shelf Life of CDIL Products**

The shelf life of products is the period from product manufacture to shipment to customers. The product can be unconditionally shipped within this period. The period is defined as 2 years.

If products are stored longer than the shelf life of 2 years the products shall be subjected to quality check as per CDIL quality procedure.

The products are further warranted for another one year after the date of shipment subject to the above conditions in CDIL original packing.

#### **Floor Life of CDIL Products and MSL Level**

When the products are opened from the original packing, the floor life will start.

For this, the following JEDEC table may be referred:

JEDEC MSL Level		
Level	Time	Condition
1	Unlimited	≤30 °C / 85% RH
2	1 Year	≤30 °C / 60% RH
2a	4 Weeks	≤30 °C / 60% RH
3	168 Hours	≤30 °C / 60% RH
4	72 Hours	≤30 °C / 60% RH
5	48 Hours	≤30 °C / 60% RH
5a	24 Hours	≤30 °C / 60% RH
6	Time on Label(TOL)	≤30 °C / 60% RH





Continental Device India Pvt. Limited

An IATF 16949, ISO9001 and ISO 14001 Certified Company



## Customer Notes

### Component Disposal Instructions

1. CDIL Semiconductor Devices are RoHS compliant, customers are requested to please dispose as per prevailing Environmental Legislation of their Country.
2. In Europe, please dispose as per EU Directive 2002/96/EC on Waste Electrical and Electronic Equipment (WEEE).

## Disclaimer

The product information and the selection guides facilitate selection of the CDIL's Semiconductor Device(s) best suited for application in your product(s) as per your requirement. It is recommended that you completely review our Data Sheet(s) so as to confirm that the Device(s) meet functionality parameters for your application. The information furnished in the Data Sheet and on the CDIL Web Site/CD are believed to be accurate and reliable. CDIL however, does not assume responsibility for inaccuracies or incomplete information. Furthermore, CDIL does not assume liability whatsoever, arising out of the application or use of any CDIL product; neither does it convey any license under its patent rights nor rights of others. These products are not designed for use in life saving/support appliances or systems. CDIL customers selling these products (either as individual Semiconductor Devices or incorporated in their end products), in any life saving/support appliances or systems or applications do so at their own risk and CDIL will not be responsible for any damages resulting from such sale(s).

CDIL strives for continuous improvement and reserves the right to change the specifications of its products without prior notice.



CDIL is a registered trademark of

**Continental Device India Pvt. Limited**

C-120 Naraina Industrial Area, New Delhi 110 028, India.

Telephone +91-11-2579 6150, 4141 1112 Fax +91-11-2579 5290, 4141 1119

email@cdil.com www.cdil.com

CIN No. U32109DL1964PTC004291