

High Reliability, Military D Subminiature, & Non-Magnetic/No-Outgas

Solder Cup

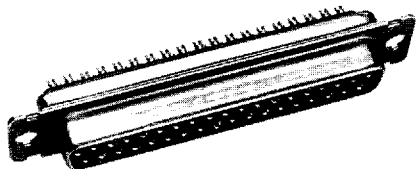

(See page 333)

Crimp

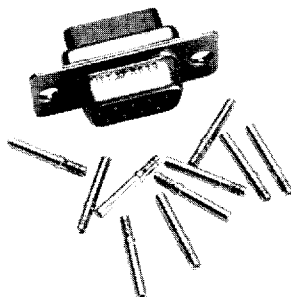

(See page 334-335)

Printed Circuit

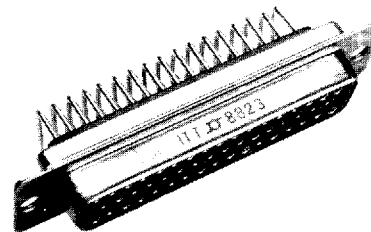

(See page 336-338)

Performance and Material Specifications

MATERIALS AND FINISHES

	Standard		Military	
	Material	Finish	Material	Finish
Shell	Steel per ASTM A-620	Yellow chromate over cadmium QQ-P-416 Type II Class 2	Steel per ASTM A-620	Yellow chromate over cadmium QQ-P-416 Type II Class 2
Insulator	Diallyl phthalate glass-filled per MIL-M-14, type SDG-F, color green	—	Diallyl phthalate glass-filled per MIL-M-14, type SDG-F, color green	—
Contact	Copper alloy	Gold over nickel	Copper alloy Crimp socket has stainless steel hood passivated.	Gold 50 microinches minimum thickness per MIL-G-45204 Type II Grade C Class 1 over copper per MIL-C-14550 Hood: Passivated
Float Mount Hardware	Stainless steel	Passivate per QQ-P-35	Stainless steel	Passivate per QQ-P-35

PERFORMANCE SPECIFICATIONS

Wire Accommodation (AWG)	Solder - #20 Max. Crimp - #18-#30 Max.
Current Rating	#20; 5 Amp
Temperature Rating	-65°C to +150°C
Contact Resistance	55 @ 7.5 Amp After Salt Spray, Millivolt Max.

See pages 339 and 340 for complete M24308 cross reference.

DIELECTRIC WITHSTANDING VOLTAGE

	90° and Straight (Solder/Crimp)			
	Altitude (feet/m)			
	Sea Level	20,000/6,096	50,000/15,240	70,000/21,336
Average Flashover	1700/1500	1000/1000	650/500	500/500
Test	1250/1000	750/650	475/325	375/325

All voltage figures are rms AC 60 rms cps, measured at approximately +25°C, 50% rh. For additional performance specifications refer to MIL-C-24308 Test Extracts on page 385.

Non-Magnetic/No-Outgas Options

Suffix Code	Residual Magnetism	Shell Material (Finish)	Desired Results
NMB	200 Gamma Residual Magnetism Insulator. (Diallyl phthalate per MIL-M-14 type SDG-F, color white.)	Brass Shells Per QQ-B-613 (Yellow Chromate over Cadmium per QQ-P-416, Type II, Class 2.)	Non-Magnetic No-Outgas
NMB-K52	200 Gamma Residual Magnetism Insulator. (Diallyl phthalate per MIL-M-14 type SDG-F, color white.)	Brass Shells Per QQ-B-613 (Gold over Copper per MIL-G-45204, Type II, Grade C, Class 1 over copper per MIL-C-14550.)	Non-Magnetic No-Outgas

Note: Look for the **NM** symbol for ordering information.

Contact Arrangements

Face View Pin Insert

Shell Size
Contact Arrangement
Contact Size

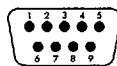

E
9
#20

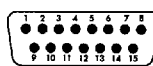

A
15
#20

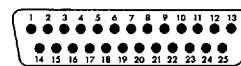

B
25
#20

Shell Size
Contact Arrangement
Contact Size

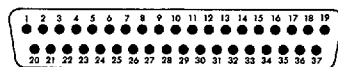

C
37
#20

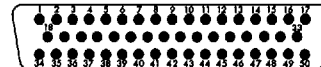

D
50
#20

D Subminiature Connectors

How to Order - High-Rel Printed Circuit Mount Connectors

Right Angle PC Tail Receptacles, With Bracket (.120(3.15) Through-Holes Only)

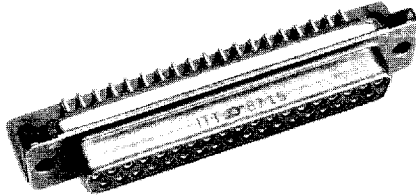

Number of Contacts (Shell Size)	PC Tails - .030 (0.76) Diameter		
	.127 (3.23) ±.027 (0.69) Long Post	.158 (4.01) ±.027 (0.69) Long Post	.183 (4.65) ±.027 (0.69) Long Post
9 (E) Standard	DEM9SD	DEM9SL	DEM9SS
9 (E) Military	DEM9SD	DEM9SL	DEM9SS
15 (A) Standard	DAM15SD	DAM15SL	DAM15SS
15 (A) Military	DAMM15SD	DAMM15SL	DAMM15SS
25 (B) Standard	DBM25SD	DBM25SL	DBM25SS
25 (B) Military	DBMM25SD	DBMM25SL	DBMM25SS
37 (C) Standard	DCM37SD	DCM37SL	DCM37SS
37 (C) Military	DCMM37SD	DCMM37SL	DCMM37SS
50 (D) Standard	DDM50SD	DDM50SL	DDM50SS
50 (D) Military	DDMM50SD	DDMM50SL	DDMM50SS

NM Non-Magnetic/No-Outgas - Add desired suffix code (NMB, NMB-K52) to end of part number. Example: DEM9SLNMB-K52

Right Angle PC Tail Plug, With Bracket (.120(3.15) Through-Holes Only)

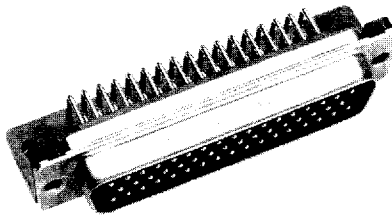

Number of Contacts (Shell Size)	PC Tails - .030 (0.76) Diameter		
	.127 (3.23) ±.027 (0.69) Long Post	.158 (4.01) ±.027 (0.69) Long Post	.183 (4.65) ±.027 (0.69) Long Post
9 (E) Standard	DEM9PD	DEM9PL	DEM9PS
9 (E) Military	DEM9PD	DEM9PL	DEM9PS
15 (A) Standard	DAM15PD	DAM15PL	DAM15PS
15 (A) Military	DAMM15PD	DAMM15PL	DAMM15PS
25 (B) Standard	DBM25PD	DBM25PL	DBM25PS
25 (B) Military	DBMM25PD	DBMM25PL	DBMM25PS
37 (C) Standard	DCM37PD	DCM37PL	DCM37PS
37 (C) Military	DCMM37PD	DCMM37PL	DCMM37PS
50 (D) Standard	DDM50PD	DDM50PL	DDM50PS
50 (D) Military	DDMM50PD	DDMM50PL	DDMM50PS

NM Non-Magnetic/No-Outgas - Add desired suffix code (NMB, NMB-K52) to end of part number. Example: DEM9PLNMB-K52

Dimensions-Right Angle 90° D Subminiature

Connectors with brackets cannot be ordered with float mounts or clinch nuts.

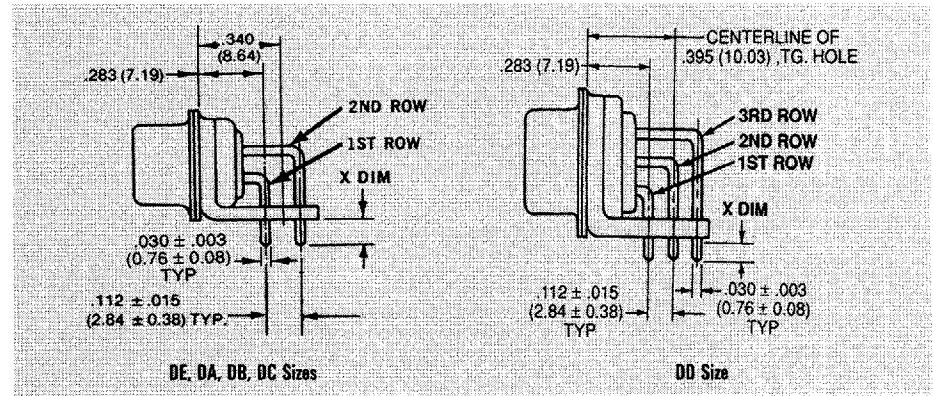

Code Last Letter of P/N's	Right Angle With Bracket	X ±.027 (0.69)
D	•	.127 (3.22)
L	•	.158 (4.01)
S	•	.183 (4.65)

Performance Specifications - Page 332

PC Board Hole Patterns

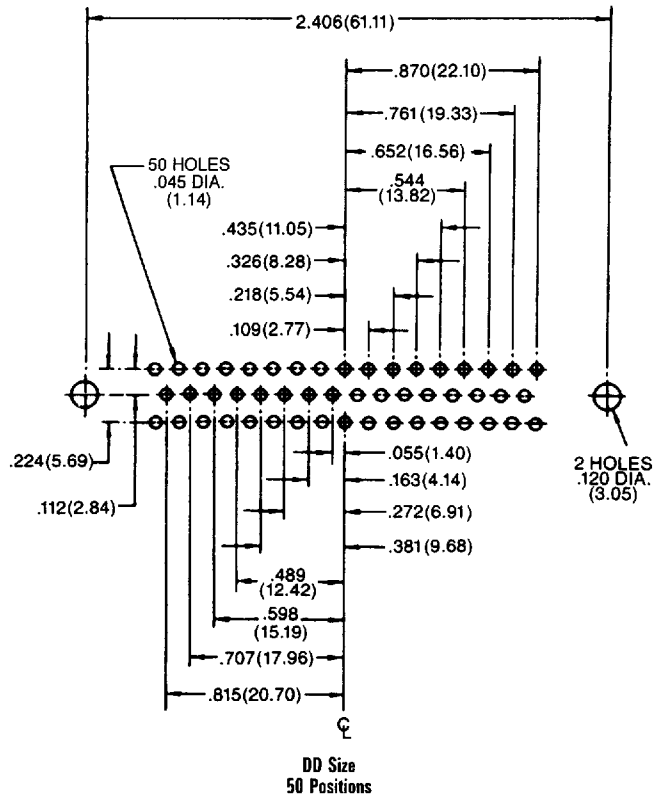
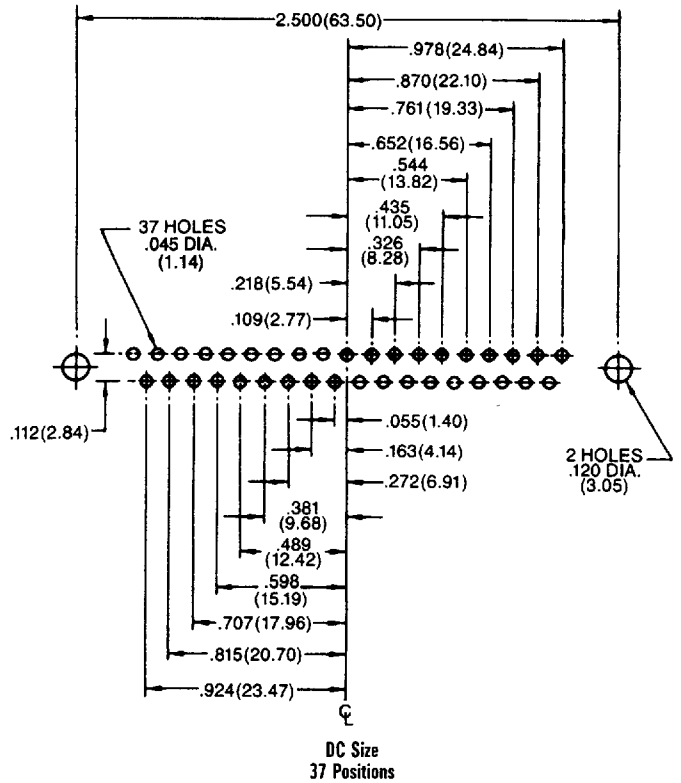
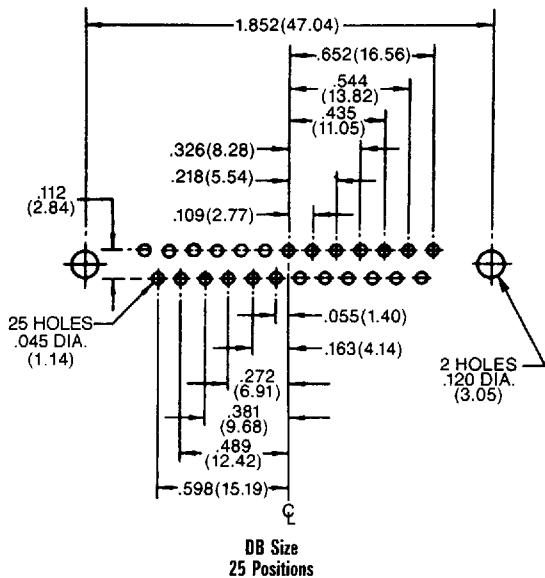
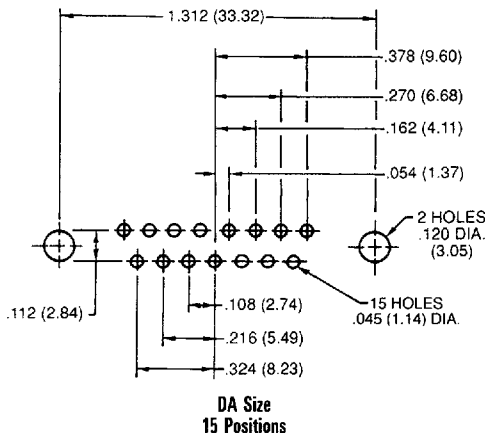
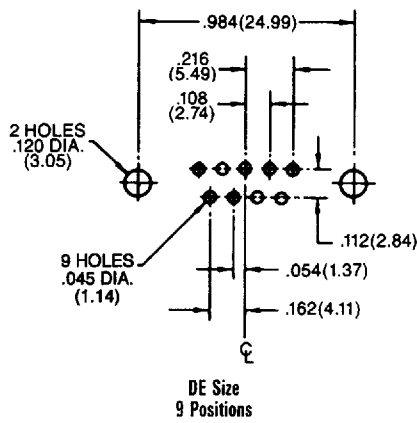

D Subminiature Connectors