

# C Series Power Rocker Switches



## Features/Benefits

- Positive detent
- Attractive design
- Snap-in mounting

## Typical Applications

- Floor care products
- Power outlet strips
- Small appliances
- RoHS compliant



## Specifications

CONTACT RATING: All Models: 15 AMPS @ 125 V AC; 10 AMPS @ 250 V AC. . Models also available with see rating section.

ELECTRICAL LIFE: 10,000 make-and-break cycles at full load.

INSULATION RESISTANCE:  $10^9 \Omega$  min.

DIELECTRIC STRENGTH: 2,500 Vrms min. @ sea level.

**NOTE:** Specifications and materials listed above are for switches with standard options. For information on specific and custom switches, consult Customer Service center.

## Materials

HOUSING & ACTUATOR: 6/6 nylon (UL 94V-2), black (standard).

MOVABLE CONTACTS: Copper, silver plated.

STATIONARY CONTACT & TERMINALS:

C121, C122 models with 'QA' rating: Copper, silver plated.

C221, C222 models with 'QA' rating: Copper.

All models with 'QF' rating: Copper, silver plated.

CONTACT SPRING: Music wire or stainless steel.

OPERATING TEMPERATURE: -30°C to +65°C

## Build-A-Switch

To order, simply select desired option from each category and place in the appropriate box. Available options are shown and described on pages G-103 and G-104. For additional options not shown in catalog, consult Customer Service Center.

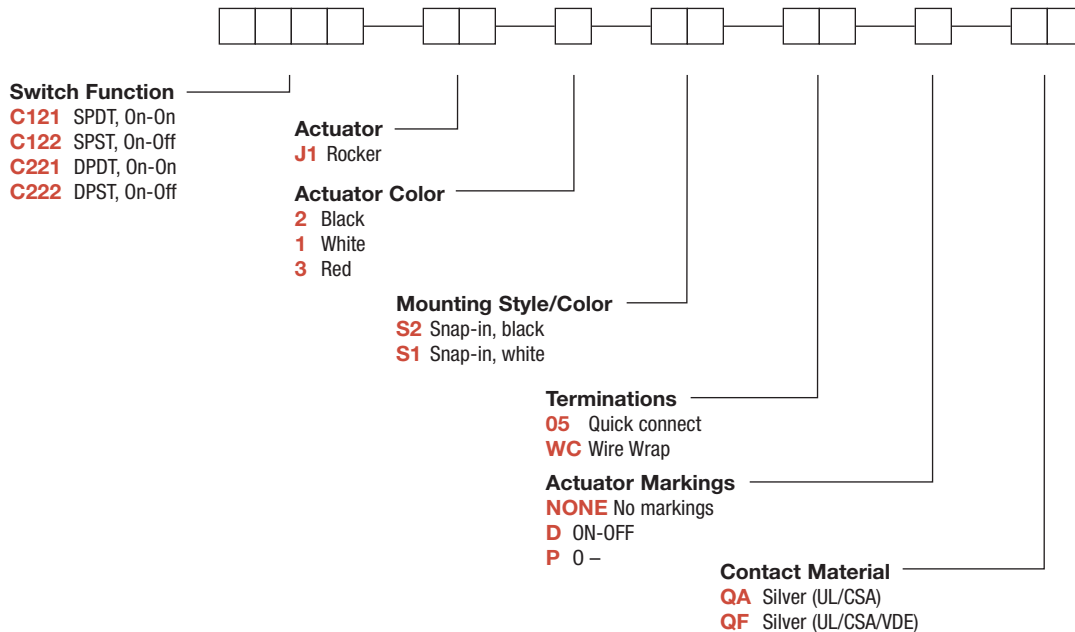

Rocker



G

**C&K**

Dimensions are shown: Inches (mm)  
Specifications and dimensions subject to change

# C Series Power Rocker Switches

## SWITCH FUNCTION



NO. POLES	MODEL NO.	SWITCH FUNCTION		CONNECTED TERMINALS		SCHEMATIC	
		POS. 1	POS. 2	POS. 1	POS. 2		
SP	<b>C121</b>	ON	ON	2-1 1-1A	2-3 1-1B	SPDT	SPDT
	<b>C122</b>	ON	OFF	2-1 1-1A	OPEN	SPST	SPST
DP	<b>C221</b>	ON	ON	1-1A, 2-2A	1-1B, 2-2B	DPDT	DPDT
	<b>C222</b>	ON	OFF	1-1A, 2-2A	OPEN	DPST	DPST

### SPDT

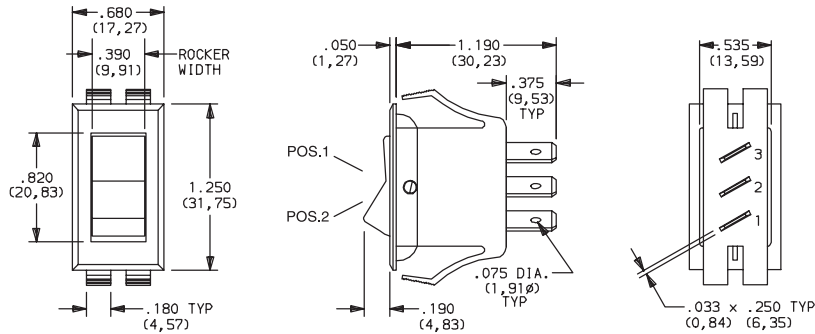

Part number shown: C121J12S205QF

TERM. NOS. FOR REFERENCE ONLY

All models with all options.

Only models with 'QF' rating meet international dimensional and electrical requirements .

Contacts make on side opposite actuator thrown.

## ACTUATOR

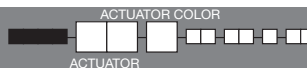

### J1

#### ROCKER

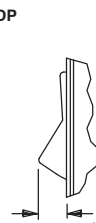
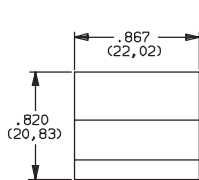
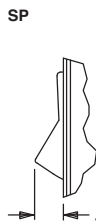
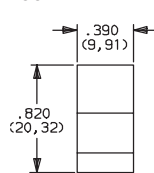

.190 (4, 83)

.190 (4, 83)

OPTION CODE	ACTUATOR COLOR
<b>2</b>	BLACK
<b>1</b>	WHITE
<b>3</b>	RED

**NOTE:** Actuator finish: gloss (standard). Other colors available, consult Customer Service Center.

## MOUNTING STYLE/COLOR



### S1, S2

#### SNAP-IN

OPTION CODE	HOUSING COLOR
<b>S2</b>	BLACK
<b>S1</b>	WHITE

**NOTE:** Frame finish on housing: gloss (standard). Other colors available, consult Customer Service Center.

#### SP

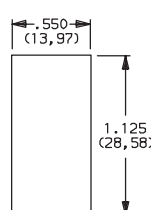

#### PANEL MOUNTING

#### DP

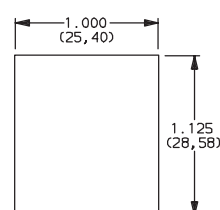

**PANEL THICKNESS:**  
.020 (0,51) TO .200 (5,08)



Dimensions are shown: Inches (mm)

Specifications and dimensions subject to change



# C Series Power Rocker Switches

## TERMINATIONS

**05** QUICK CONNECT

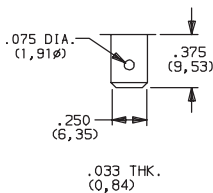

**WC** WIRE WRAP

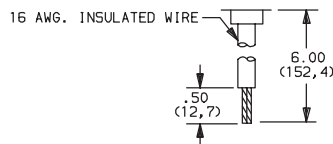

Available with 'QA' contact material only,  
( only) SP models only.  
Black wire standard, other colors and lengths available, consult Customer Service Center. UL style 1015.

## ACTUATOR MARKINGS

**NONE** NO MARKING



**D** ON-OFF



**P** O -

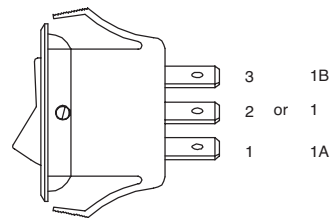
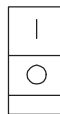

**NOTE:** Orientation of actuator markings and terminals.

'D, H, K & P' marking options: marking color white, standard for all actuator colors except white. Black, standard for white actuators. Consult Customer Service Center for other available markings and colors.

Shown in Pos. 1

## CONTACT MATERIAL

OPTION CODE	CONTACT AND TERMINAL MATERIAL	RATINGS	
		POWER	15 AMPS @ 125 V AC; 10 AMPS @ 250 V AC (UL/CSA).
QA	SILVER 1,2	POWER	15 AMPS @ 125 V AC; 10 AMPS @ 250 V AC (UL/CSA).
QF		POWER	15 AMPS @ 125 V AC; 10 AMPS @ 250 V AC (UL/CSA/VDE).

\* Note: See Technical Data section of this catalog for RoHS compliant and compatible definitions and specifications.

<sup>1</sup> STATIONARY CONTACT & TERMINALS:

All models with 'QA' rating: Copper, silver plated.  
All models with 'QF' rating: Copper, silver top lay.

<sup>2</sup> MOVABLE CONTACTS: Copper, silver plated.

All models .

Only models with 'QF' rating meet international dimensional and electrical requirements .

**NOTE:** 'QF' rating available with '05' terminations only.

Rocker



G

**C&K**



Third Angle Projection

Dimensions are shown: Inches (mm)  
Specifications and dimensions subject to change