

GPP TRANSIENT VOLTAGE SUPPRESSOR
5000 WATT PEAK POWER 8.0 WATTS STEADY STATE

FEATURES

- * Plastic package has underwriters laboratory
- * Glass passivated chip construction
- * 5000 watt surge capability at 1ms
- * Excellent clamping capability
- * Low zener impedance
- * Fast response time
- * P/N suffix V means AEC-Q101 qualified, e.g:5KP5.0V
- * P/N suffix V means Halogen-free

MAXIMUM RATINGS AND ELECTRICAL CHARACTERISTICS

Ratings at 25 °C ambient temperature unless otherwise specified.

Single phase, half wave, 60 Hz, resistive or inductive load,

For capacitive load, derate current by 20%.



R-6

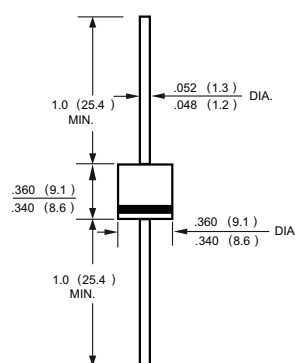

Dimensions in inches and (millimeters)

DEVICES FOR BIPOLAR APPLICATIONS

For Bidirectional use C or CA suffix for types 5KP5.0 thru 5KP250A

Electrical characteristics apply in both direction

MAXIMUM RATINGS (At TA = 25°C unless otherwise noted)

RATINGS	SYMBOL	VALUE	UNITS
Peak Pulse Power Dissipation with a 10/1000uS waveform (Note 1, FIG.1)	PPPM	Minimum 5000	Watts
Peak Pulse Current with a 10/1000uS waveform (Note 1, Fig. 3)	IPPM	SEE TABLE 1	Amps
Steady State Power Dissipation at TL = 75°C lead lengths 0.375" (9.5mm) (Note 2)	PM(AV)	8.0	Watts
Peak Forward Surge Current, 8.3ms single half sine wave-superimposed on rated load(JEDEC METHOD) (Note 3)	IFSM	600	Amps
Typical Current Squared Time	i ² T	1494	A ² S
Instantaneous Forward Voltage at 100A, (Note 3)	VF	3.5/5.0	Volts
Operating and Storage Temperature Range	TJ, TstG	-55 to + 175	°C

- NOTES : 1. Non-repetitive current pulse, per Fig.3 and derated above TA = 25°C per Fig.2.
 2. Mounted on copper pad area of 0.8 X 0.8" (20 X 20mm) per Fig. 5
 3. Measured on 8.3mS single half sine-wave or equivalent square wave, duty cycle = 4 pulses per minute maximum.
 4. VF<3.5V for devices of VBR _< 200V and VF<5.0V for devices of VBR _> 201V.

2019-04
REV: D

RATING AND CHARACTERISTIC CURVES (5KP5.0 THRU 5KP250CA)

FIG. 1 - PEAK PULSE POWER RATING CURVE

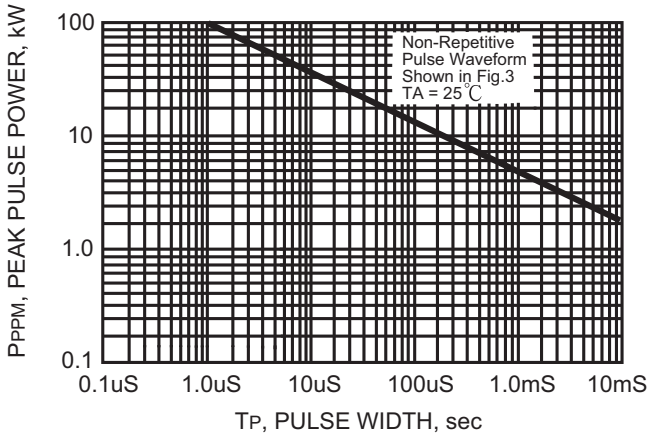

FIG. 2 - PULSE DERATING CURVE

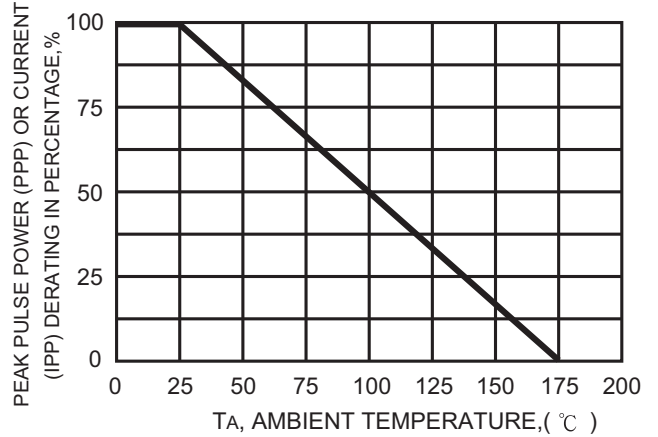

FIG. 3 - PULSE WAVEFORM

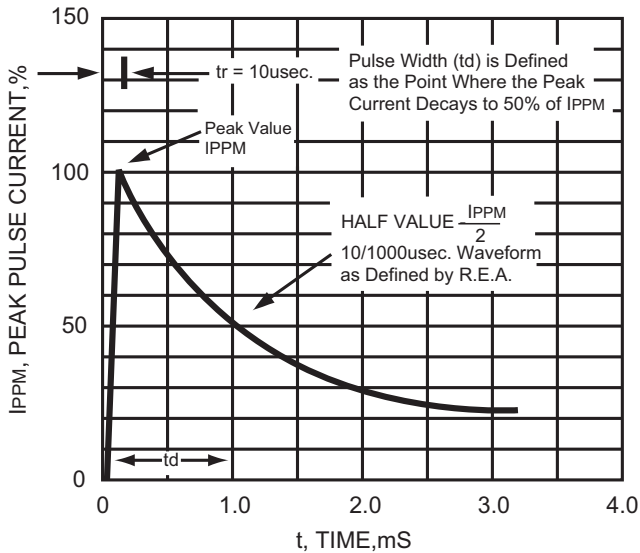

FIG. 4 - TYPICAL JUNCTION CAPACITANCE

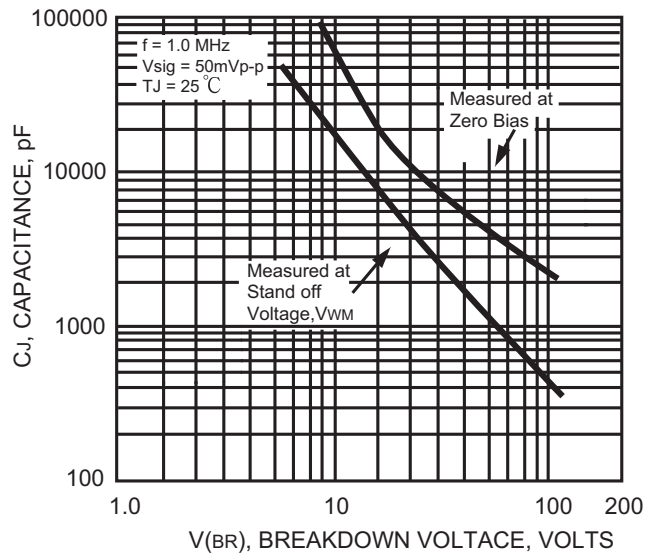

FIG. 5 - STEADY STATE POWER DERATING CURVE

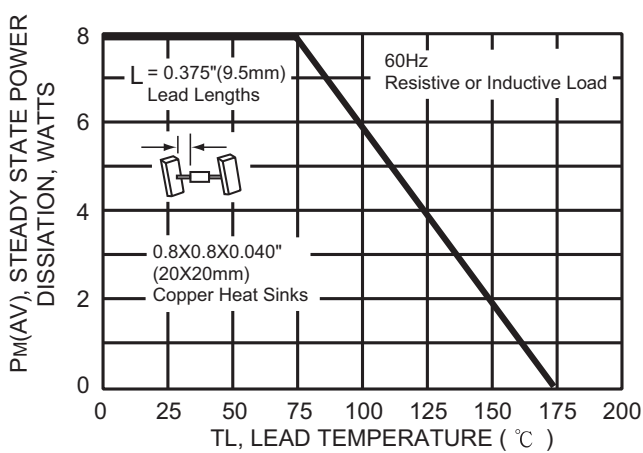
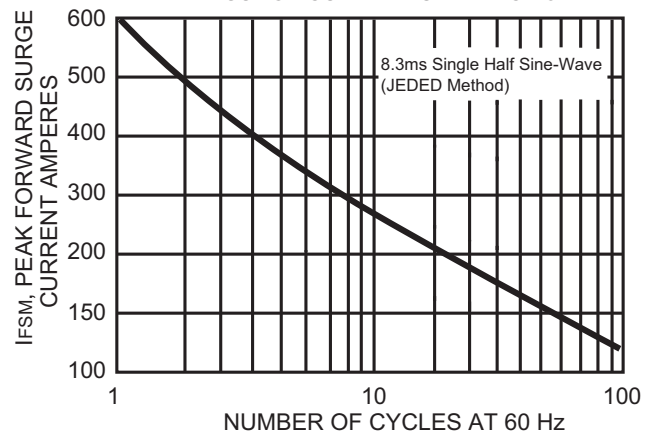

FIG. 6 - MAXIMUM NON-REPETITIVE FORWARD SURGE CURRENT UNIDIRECTIONAL



TRANSIENT VOLTAGE SUPPRESSORS

5000W SERIES TVS DIODES / R-6 (CASE 12) 5000W

TYPE	Breakdown Voltage		@IT (mA)	Reverse Stand off Voltage VWM (Volts)	Maximum Reverse Leakage at VWM ID(uA)	Maximum Peak Pulse Current IPPM (Amps)	Maximum Clamping Voltage at IPPM VC (Volts)
	VBR (Volts)						
	MIN.	MAX.					
5KP5.0	6.40	7.30	50	5.0	2000	521	9.6
5KP5.0A	6.40	7.00	50	5.0	2000	543	9.2
5KP6.0	6.67	8.15	50	6.0	5000	439	11.4
5KP6.0A	6.67	7.37	50	6.0	5000	485	10.3
5KP6.5	7.22	8.82	50	6.5	2000	407	12.3
5KP6.5A	7.22	7.98	50	6.5	2000	446	11.2
5KP7.0	7.78	9.51	50	7.0	1000	376	13.3
5KP7.0A	7.78	8.60	50	7.0	1000	417	12.0
5KP7.5	8.33	10.2	5.0	7.5	250	350	14.3
5KP7.5A	8.33	9.21	5.0	7.5	250	388	12.9
5KP8.0	8.89	10.9	5.0	8.0	150	333	15.0
5KP8.0A	8.89	9.83	5.0	8.0	150	368	13.6
5KP8.5	9.44	11.5	5.0	8.5	50	314	15.9
5KP8.5A	9.44	10.4	5.0	8.5	50	347	14.4
5KP9.0	10.0	12.2	5.0	9.0	20	296	16.9
5KP9.0A	10.0	11.1	5.0	9.0	20	325	15.4
5KP10	11.1	13.6	5.0	10.0	15	266	18.8
5KP10A	11.1	12.3	5.0	10.0	15	294	17.0
5KP11	12.2	14.9	5.0	11.0	10	249	20.1
5KP11A	12.2	13.5	5.0	11.0	10	275	18.2
5KP12	13.3	16.3	5.0	12.0	10	227	22.0
5KP12A	13.3	14.7	5.0	12.0	10	251	19.9
5KP13	14.4	17.6	5.0	13.0	10	210	23.8
5KP13A	14.4	15.9	5.0	13.0	10	233	21.5
5KP14	15.6	19.1	5.0	14.0	10	194	25.8
5KP14A	15.6	17.2	5.0	14.0	10	216	23.2
5KP15	16.7	20.4	5.0	15.0	10	186	26.9
5KP15A	16.7	18.5	5.0	15.0	10	205	24.4
5KP16	17.8	21.8	5.0	16.0	10	174	28.8
5KP16A	17.8	19.7	5.0	16.0	10	192	26.0
5KP17	18.9	23.1	5.0	17.0	10	164	30.5
5KP17A	18.9	20.9	5.0	17.0	10	181	27.6
5KP18	20.0	24.4	5.0	18.0	10	155	32.2
5KP18A	20.0	22.1	5.0	18.0	10	171	29.2
5KP20	22.2	27.1	5.0	20.0	10	140	35.8
5KP20A	22.2	24.5	5.0	20.0	10	154	32.4
5KP22	24.4	29.8	5.0	22.0	10	127	39.4
5KP22A	24.4	26.9	5.0	22.0	10	141	35.5
5KP24	26.7	32.6	5.0	24.0	10	116	43.0
5KP24A	26.7	29.5	5.0	24.0	10	129	38.9
5KP26	28.9	35.3	5.0	26.0	10	107	46.6
5KP26A	28.9	31.9	5.0	26.0	10	119	42.1
5KP28	31.1	38.0	5.0	28.0	10	100	50.1
5KP28A	31.1	34.4	5.0	28.0	10	110	45.4
5KP30	33.3	40.7	5.0	30.0	10	93.5	53.5
5KP30A	33.3	36.8	5.0	30.0	10	103	48.4

TRANSIENT VOLTAGE SUPPRESSORS

5000W SERIES TVS DIODES / R-6 (CASE 12) 5000W

TYPE	Breakdown Voltage		@I _T (mA)	Reverse Stand off Voltage V _{WM} (Volts)	Maximum Reverse Leakage at V _{WM} I _D (uA)	Maximum Peak Pulse Current I _{PPM} (Amps)	Maximum Clamping Voltage at I _{PPM} V _C (Volts)
	V _{BR} (Volts)						
	MIN.	MAX.					
5KP33	36.7	44.9	5.0	33.0	10	84.7	59.0
5KP33A	36.7	40.6	5.0	33.0	10	93.8	53.3
5KP36	40.0	48.9	5.0	36.0	10	77.8	64.3
5KP36A	40.0	44.2	5.0	36.0	10	86.1	58.1
5KP40	44.4	54.3	5.0	40.0	10	70.0	71.4
5KP40A	44.4	49.1	5.0	40.0	10	77.5	64.5
5KP43	47.8	58.4	5.0	43.0	10	65.2	76.7
5KP43A	47.8	52.8	5.0	43.0	10	72.0	69.4
5KP45	50.0	61.1	5.0	45.0	10	62.3	80.3
5KP45A	50.0	55.3	5.0	45.0	10	68.8	72.7
5KP48	53.3	65.2	5.0	48.0	10	58.5	85.5
5KP48A	53.3	58.9	5.0	48.0	10	64.6	77.4
5KP51	56.7	69.3	5.0	51.0	10	54.9	91.1
5KP51A	56.7	62.7	5.0	51.0	10	60.7	82.4
5KP54	60.0	73.3	5.0	54.0	10	51.9	96.3
5KP54A	60.0	66.3	5.0	54.0	10	57.4	87.1
5KP58	64.4	78.7	5.0	58.0	10	48.5	103
5KP58A	64.4	71.2	5.0	58.0	10	53.4	94
5KP60	66.7	81.5	5.0	60.0	10	46.7	107
5KP60A	66.7	73.7	5.0	60.0	10	51.7	97
5KP64	71.1	96.9	5.0	64.0	10	43.9	114
5KP64A	71.1	78.6	5.0	64.0	10	48.5	103
5KP70	77.8	95.1	5.0	70.0	10	40.0	125
5KP70A	77.8	86.0	5.0	70.0	10	44.2	113
5KP75	83.3	102	5.0	75.0	10	37.3	134
5KP75A	83.3	92.1	5.0	75.0	10	41.3	121
5KP78	86.7	106	5.0	78.0	10	36.0	139
5KP78A	86.7	95.8	5.0	78.0	10	39.7	126
5KP85	94.4	115	5.0	85.0	10	33.1	151
5KP85A	94.4	104	5.0	85.0	10	36.5	137
5KP90	100	122	5.0	90.0	10	31.3	160
5KP90A	100	111	5.0	90.0	10	34.2	146
5KP100	111	136	5.0	100	10	27.9	179
5KP100A	111	123	5.0	100	10	30.9	162
5KP110	122	149	5.0	110	10	25.5	196
5KP110A	122	135	5.0	110	10	28.2	177

- Notes :
1. V_{BR} measured after I_T applied for 300ms. I_T = square pulse or equivalent.
 2. All devices UL listed under file# E211196.

TRANSIENT VOLTAGE SUPPRESSORS

5000W SERIES TVS DIODES / R-6 (CASE 12) 5000W

TYPE	Breakdown Voltage		@I _T (mA)	Reverse Stand off Voltage V _{WM} (Volts)	Maximum Reverse Leakage at V _{WM} I _D (uA)	Maximum Peak Pulse Current I _{PPM} (Amps)	Maximum Clamping Voltage at I _{PPM} V _C (Volts)
	V _{BR} (Volts)						
	MIN.	MAX.					
5KP120A	133	147	5.0	120	10	26.4	193
5KP130A	144	159	5.0	130	10	24.4	209
5KP150A	167	185	5.0	150	10	21.0	243
5KP160A	178	197	5.0	160	10	19.7	259
5KP170A	189	209	5.0	170	10	18.5	275
5KP180A	200	221	5.0	180	10	17.5	292
5KP190A	211	233	5.0	190	10	16.5	310
5KP200A	222	246	5.0	200	10	15.5	329.2
5KP210A	233	258	5.0	210	10	14.6	349.5
5KP220A	244	270	5.0	220	10	13.7	371.1
5KP250A	277	306	5.0	250	10	12.0	425

- Notes :
1. V_{BR} measured after I_T applied for 300ms. I_T = square pulse or equivalent.
 2. All devices UL listed under file# E211196.

Attachment information about 5KPXXX

Mark Description

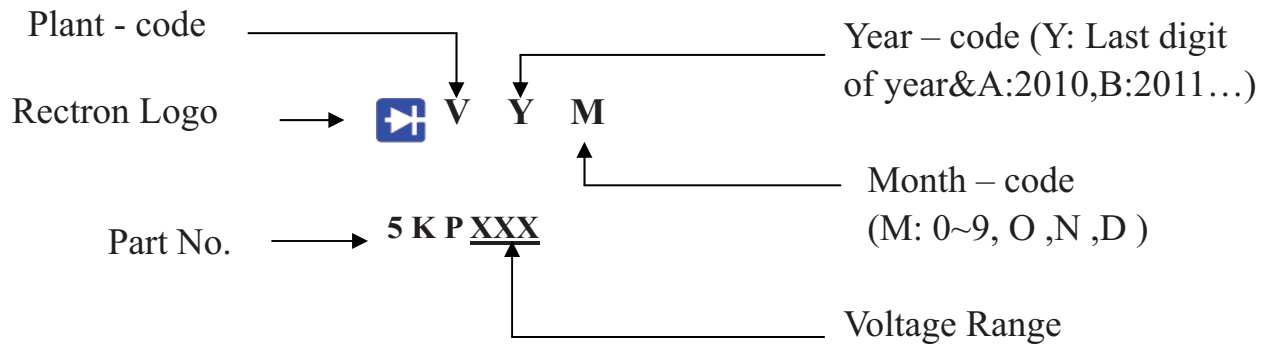

PACKAGING OF DIODE AND BRIDGE RECTIFIERS

BULK PACK

PACKAGE	PACKING CODE	EA PER BOX	INNER BOX SIZE (mm)	CARTON SIZE (mm)	EA PER CARTON	GROSS WEIGHT(Kg)
R-6/R-7	-B	200	300*73*40	347*320*271	4,800	12.93/14.57

REEL PACK

PACKAGE	PACKING CODE	EA PER REEL	EA PER INNER BOX	COMPONENT SPACE (mm)	TAPE SPACE (mm)	REEL DIA (mm)	CARTON SIZE (mm)	EA PER CARTON	GROSS WEIGHT(Kg)
R-6/R-7	-T	800	800	9.5	52	330	355*350*335	3,200	9.72/9.91

AMMO PACK

PACKAGE	PACKING CODE	REEL (EA)	COMPONENT SPACE(mm)	TAPE SPACE (mm)	BOX SIZE (mm)	CARTON SIZE(mm)	CARTON (EA)	GROSS WEIGHT (Kg)
R-6/R-7	-F	300	9.5	52	255*73*100	400*268*225	3,000	8.5/8.7

DISCLAIMER NOTICE

Rectron Inc reserves the right to make changes without notice to any product specification herein, to make corrections, modifications, enhancements or other changes. Rectron Inc or anyone on its behalf assumes no responsibility or liability for any errors or inaccuracies. Data sheet specifications and its information contained are intended to provide a product description only. "Typical" parameters which may be included on RECTRON data sheets and/ or specifications can and do vary in different applications and actual performance may vary over time. Rectron Inc does not assume any liability arising out of the application or use of any product or circuit.

Rectron products are not designed, intended or authorized for use in medical, life-saving implant or other applications intended for life-sustaining or other related applications where a failure or malfunction of component or circuitry may directly or indirectly cause injury or threaten a life without expressed written approval of Rectron Inc. Customers using or selling Rectron components for use in such applications do so at their own risk and shall agree to fully indemnify Rectron Inc and its subsidiaries harmless against all claims, damages and expenditures.