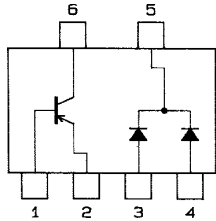

**FX802**

TR:PNP Epitaxial Planar Silicon Transistor  
 SBD:Schottky Barrier Diode (Twin type · Cathode Common)

**DC-DC Converter****Features**

- Complex type of a low saturation voltage, high speed switching and large current PNP transistor and a fast recovery and low forward voltage Schottky barrier diode facilitating high-density mounting.
- The FX802 is composed of 2 chips, one being equivalent to the 2SB1302 and the other the SB20W03P, placed in one package.

**Electrical Connection**

- 1:Base  
 2:Emitter  
 3:Anode1  
 4:Anode2  
 5:Cathode  
 6:Collector

(Top view)

**Package Dimensions**

unit:mm

2126

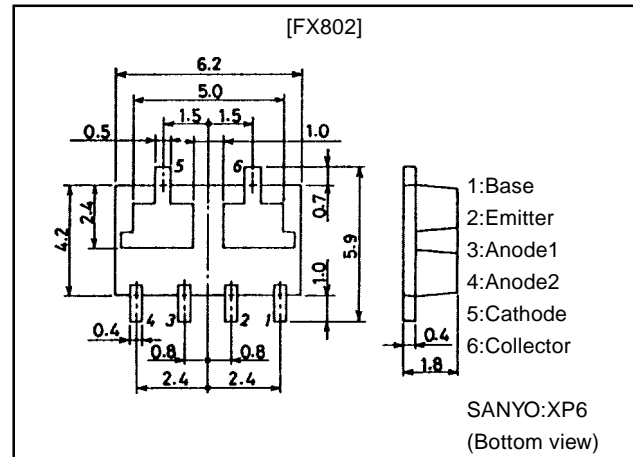
**Specifications****Absolute Maximum Ratings at Ta = 25°C**

Parameter	Symbol	Conditions	Ratings	Unit
[TR]				
Collector-to-Base Voltage	$V_{CBO}$		-25	V
Collector-to-Emitter Voltage	$V_{CEO}$		-20	V
Emitter-to-Base Voltage	$V_{EBO}$		-5	V
Collector Current	$I_C$		-5	A
Collector Current (Pulse)	$I_{CP}$		-8	A
Base Current	$I_B$		-1	A
Collector Dissipation	$P_C$	Mounted on ceramic board (750mm <sup>2</sup> ×0.8mm) 1 unit	1.5	W
Junction Temperature	$T_J$		150	°C
[SBD]				
Repetitive Peak Reverse Voltage	$V_{RRM}$		30	V
Non-repetitive Peak Reverse Surge Voltage	$V_{RSM}$		35	V
Average Rectified Current	$I_O$		2	A
	$I_O$	(Total)	4	A
Surge Forward Current	$I_{FSM}$	50Hz sine wave, 1 cycle	10	A
Junction Temperature	$T_J$		-55 to +125	°C
Storage Temperature	$T_{stg}$		-55 to +125	°C

· Marking:802

Continued on next page.

**SANYO Electric Co.,Ltd. Semiconductor Business Headquarters**

TOKYO OFFICE Tokyo Bldg., 1-10, 1 Chome, Ueno, Taito-ku, TOKYO, 110-8534 JAPAN

52098HA (KT)/41095TS (KOTO) TA-0134 No.5052-1/4

# FX802

Continued from preceding page.

## Electrical Characteristics at Ta = 25°C

Parameter	Symbol	Conditions	Ratings			Unit
			min	typ	max	
[TR]						
Collector Cutoff Current	$I_{CBO}$	$V_{CB}=-20V, I_E=0$			-500	nA
Emitter Cutoff Current	$I_{EBO}$	$V_{EB}=-4V, I_C=0$			-500	nA
DC Current Gain	$h_{FE1}$	$V_{CE}=-2V, I_C=-500mA$	140		400	
	$h_{FE2}$	$V_{CE}=-2V, I_C=-4A$	60			
Gain-Bandwidth Product	$f_T$	$V_{CE}=-5V, I_C=-200mA$		320		MHz
Output Capacitance	$C_{ob}$	$V_{CE}=-10V, f=1MHz$		60		pF
C-E Saturation Voltage	$V_{CE(sat)}$	$I_C=-3A, I_B=-60mA$		-250	-500	mV
B-E Saturation Voltage	$V_{BE(sat)}$	$I_C=-3A, I_B=-60mA$		-1.0	-1.3	V
C-B Breakdown Voltage	$V_{(BR)CBO}$	$I_C=-10\mu A, I_E=0$	-25			V
C-E Breakdown Voltage	$V_{(BR)CEO}$	$I_E=-1mA, R_{BE}=\infty$	-20			V
E-B Breakdown Voltage	$V_{(BR)EBO}$	$I_E=-10\mu A, I_C=0$	-5			V
Turn-ON Time	$t_{on}$	See sepcified Test Circuit		40		ns
Storage Time	$t_{stg}$	See sepcified Test Circuit		200		ns
Fall Time	$t_f$	See sepcified Test Circuit		10		ns
[SBD] (Value per element)						
Reverse Voltage	$V_R$	$I_R=500\mu A$	30			V
Forward Voltage	$V_F$	$I_F=2A$			0.55	V
Reverse Current	$I_R$	$V_R=15V$			100	$\mu A$
Interterminal Capacitance	$C$	$V_R=10V, f=1MHz$		70		pF
Reverse Recovery Time	$t_{rr}$	$I_F=I_R=100mA$ , See specified Test Circuit			20	ns
Thermal Resistance	$R_{thj-a}$	Mounted on ceramic board (750mm <sup>2</sup> ×0.8mm)		85		°C/W

### Switching Time Test Circuit

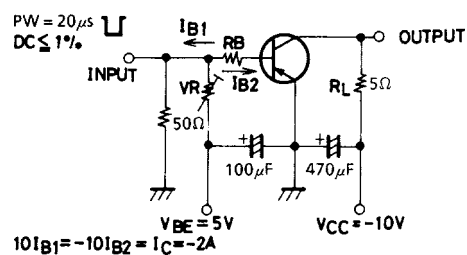

### Trr Test Circuit

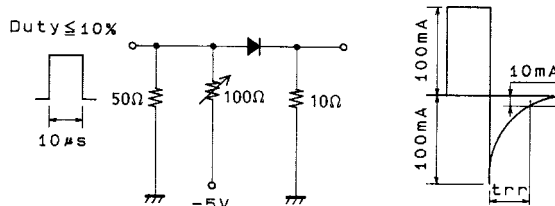

# FX802

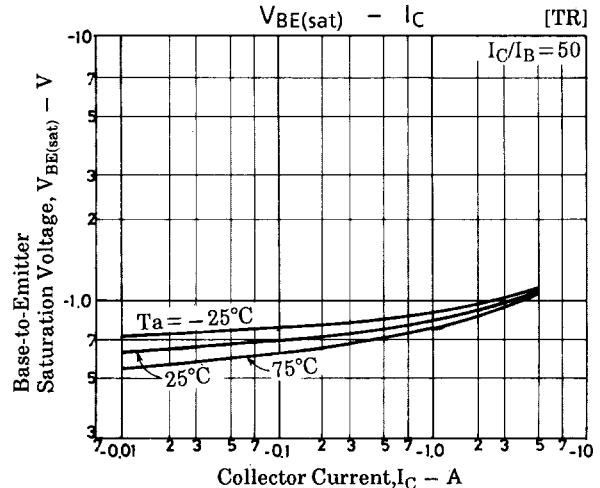
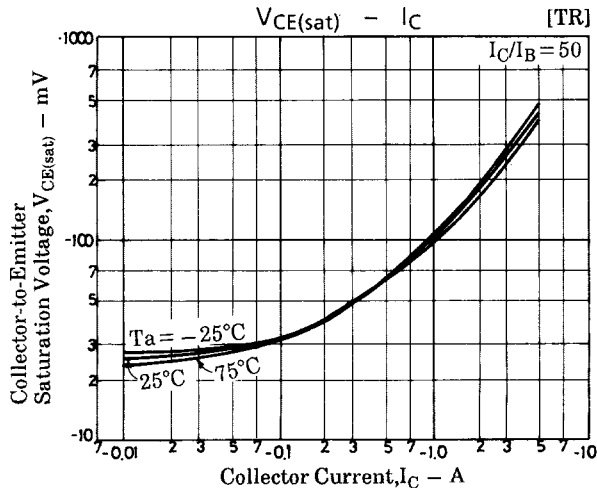
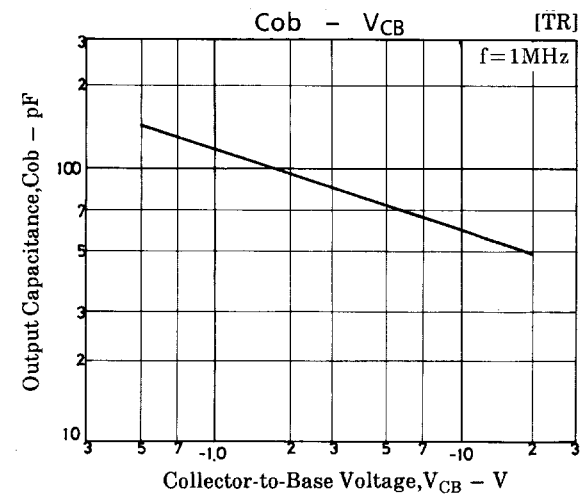
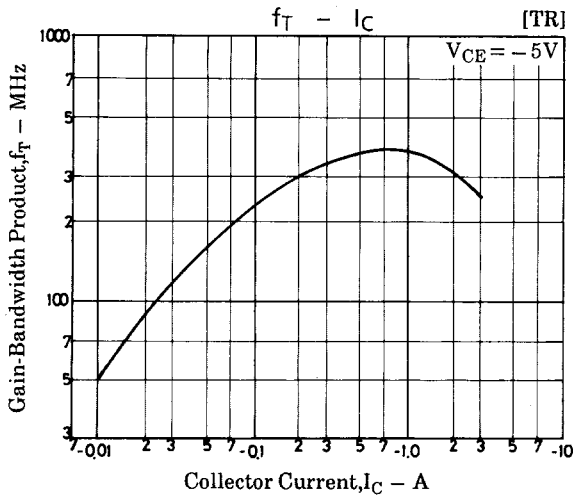
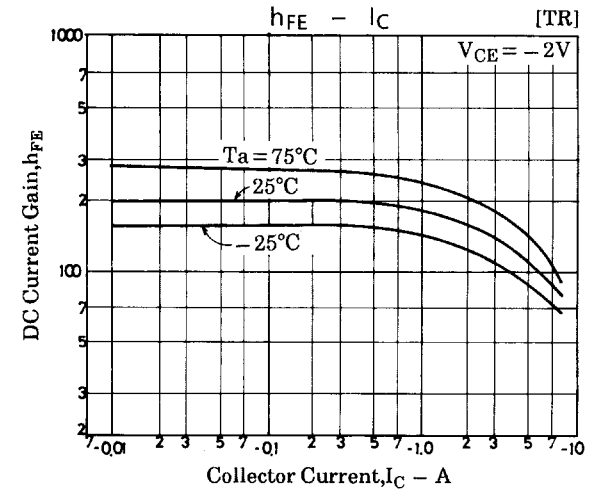
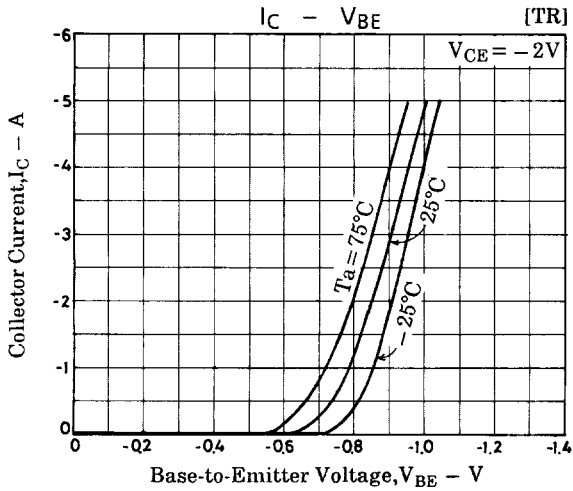
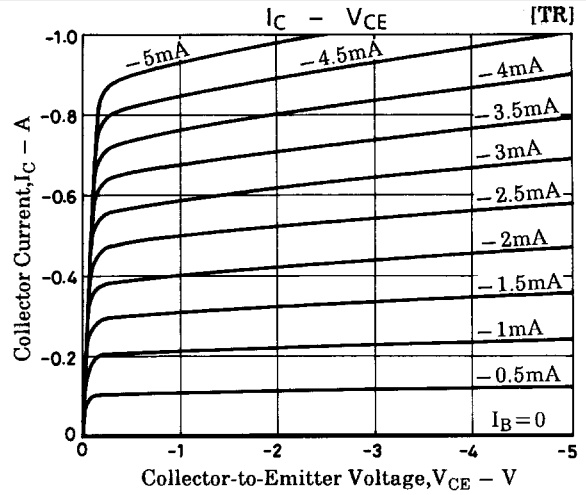
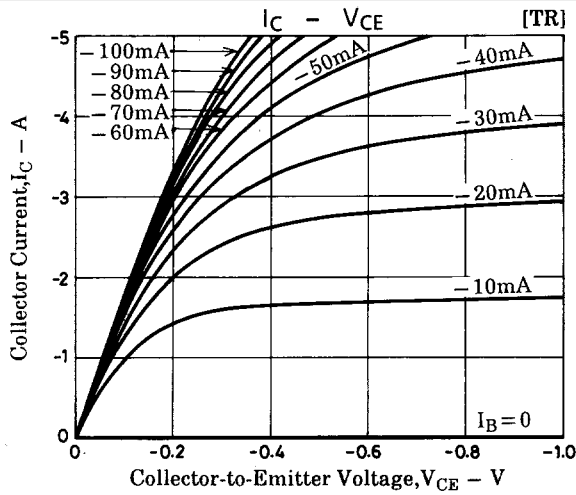

# FX802

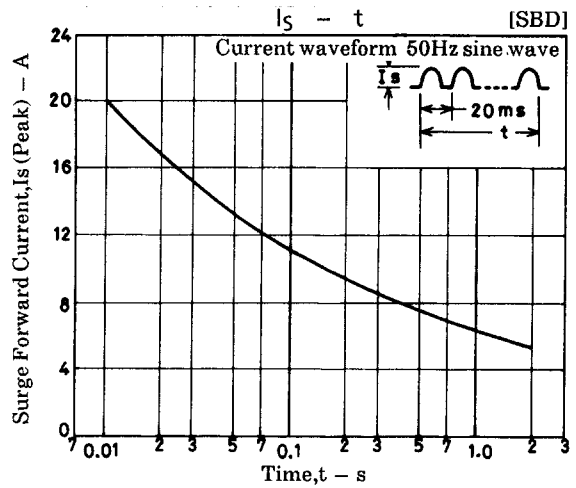
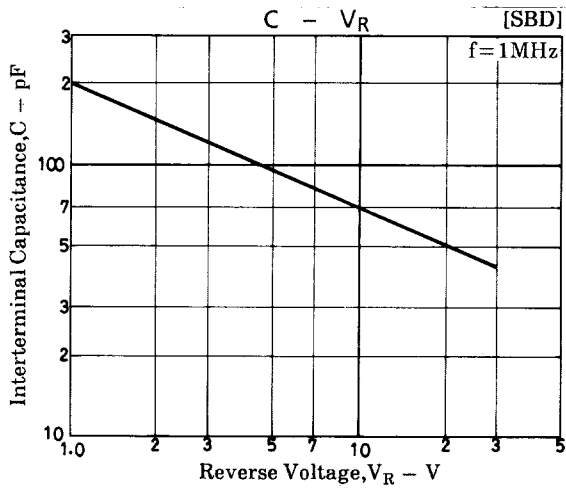
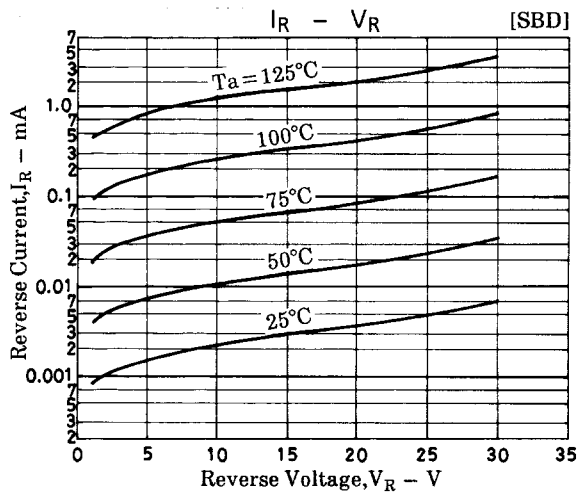
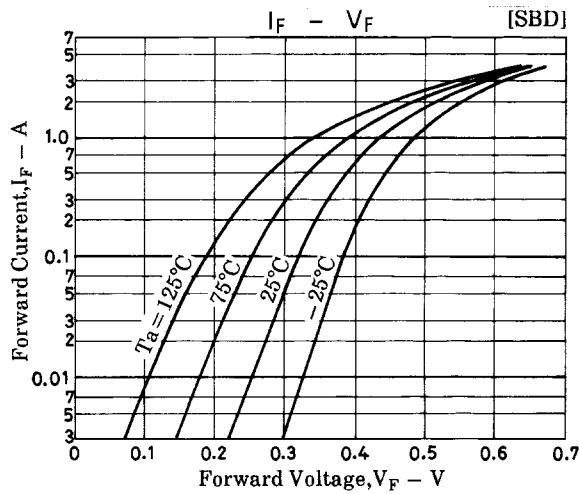
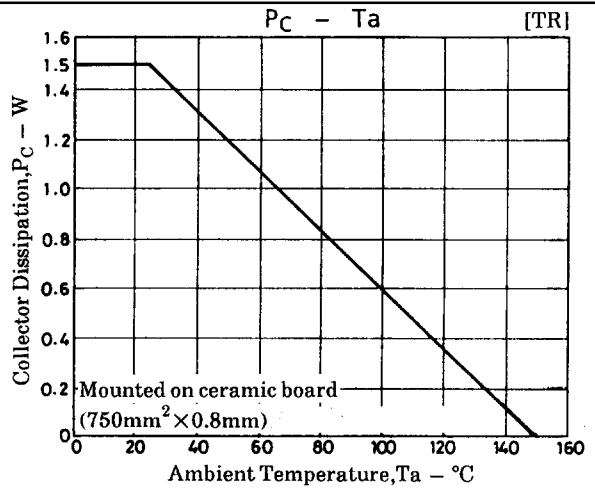
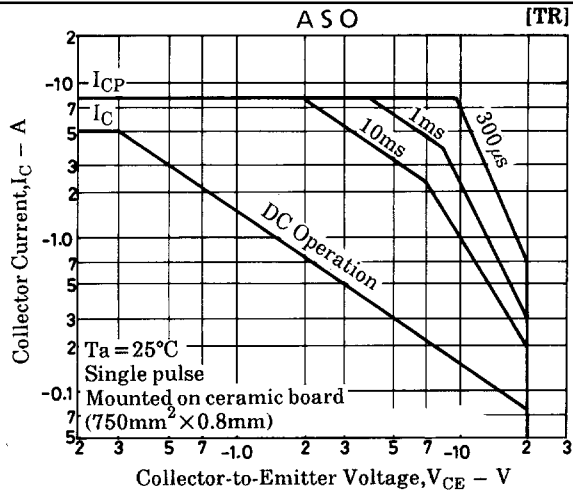

- No products described or contained herein are intended for use in surgical implants, life-support systems, aerospace equipment, nuclear power control systems, vehicles, disaster/crime-prevention equipment and the like, the failure of which may directly or indirectly cause injury, death or property loss.
- Anyone purchasing any products described or contained herein for an above-mentioned use shall:
  - ① Accept full responsibility and indemnify and defend SANYO ELECTRIC CO., LTD., its affiliates, subsidiaries and distributors and all their officers and employees, jointly and severally, against any and all claims and litigation and all damages, cost and expenses associated with such use:
  - ② Not impose any responsibility for any fault or negligence which may be cited in any such claim or litigation on SANYO ELECTRIC CO., LTD., its affiliates, subsidiaries and distributors or any of their officers and employees jointly or severally.
- Information (including circuit diagrams and circuit parameters) herein is for example only; it is not guaranteed for volume production. SANYO believes information herein is accurate and reliable, but no guarantees are made or implied regarding its use or any infringements of intellectual property rights or other rights of third parties.

This catalog provides information as of May, 1998. Specifications and information herein are subject to change without notice.