

## SURFACE MOUNT FAST SWITCHING DIODE

### Features

- High Conductance
- Fast Switching Speed
- Surface Mount Package Ideally Suited for Automatic Insertion
- For General Purpose Switching Application
- Plastic Material – UL Recognition Flammability Classification 94V-O

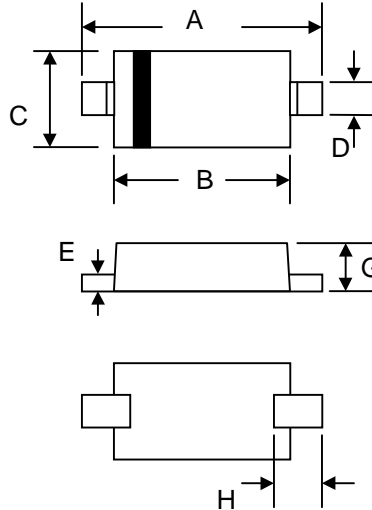

SOD-323		
Dim	Min	Max
A	2.30	2.70
B	1.75	1.95
C	1.15	1.35
D	0.25	0.35
E	0.05	0.15
G	0.70	0.95
H	0.30	—
All Dimensions in mm		

### Mechanical Data

- Case: SOD-323, Molded Plastic
- Terminals: Plated Leads Solderable per MIL-STD-202, Method 208
- Polarity: Cathode Band
- Weight: 0.004 grams (approx.)
- Marking: A2

### Maximum Ratings @ $T_A=25^\circ\text{C}$ unless otherwise specified

Characteristic	Symbol	Value	Unit
Non-Repetitive Peak Reverse Voltage	$V_{RM}$	100	V
Peak Repetitive Reverse Voltage Working Peak Reverse Voltage DC Blocking Voltage	$V_{RRM}$ $V_{RWM}$ $V_R$	75	V
RMS Reverse Voltage	$V_{R(RMS)}$	53	V
Forward Continuous Current (Note 1)	$I_{FM}$	300	mA
Average Rectified Output Current (Note 1)	$I_O$	150	mA
Non-Repetitive Peak Forward Surge Current @ $t = 1.0\mu\text{s}$ @ $t = 1.0\text{s}$	$I_{FSM}$	2.0 1.0	A
Power Dissipation (Note 1)	$P_d$	200	mW
Typical Thermal Resistance, Junction to Ambient Air (Note 1)	$R_{\theta JA}$	625	K/W
Operating and Storage Temperature Range	$T_j, T_{STG}$	-65 to +150	$^\circ\text{C}$

### Electrical Characteristics @ $T_A=25^\circ\text{C}$ unless otherwise specified

Characteristic	Symbol	Value	Unit
Forward Voltage Drop @ $I_F = 10\text{mA}$	$V_{FM}$	1.0	V
Peak Reverse Leakage Current @ $V_R = 75\text{V}$	$I_{RM}$	2.5	$\mu\text{A}$
Junction Capacitance ( $V_R = 0\text{V DC}, f = 1.0\text{MHz}$ )	$C_j$	2.0	pF
Reverse Recovery Time (Note 2)	$t_{rr}$	4.0	nS

Note: 1. Valid provided that terminals are kept at ambient temperature.  
2. Measured with  $I_F = I_R = 10\text{mA}$ ,  $I_{RR} = 0.1 \times I_R$ ,  $R_L = 100\Omega$ .

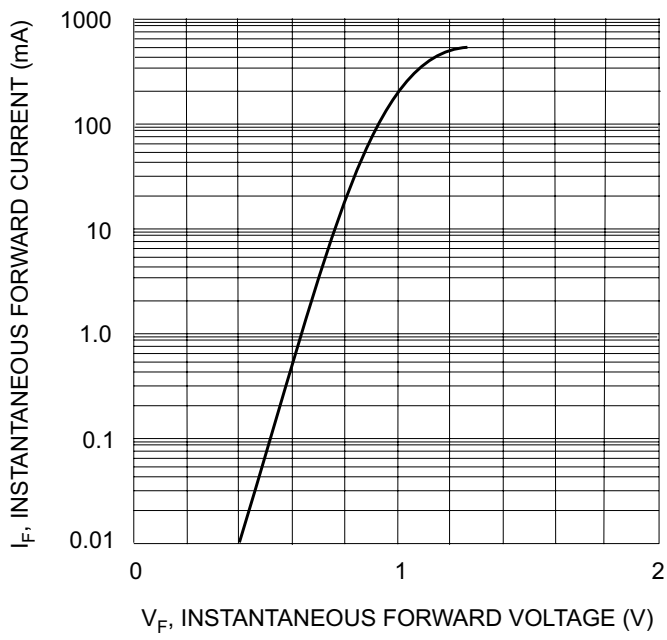

Fig. 1 Forward Characteristics

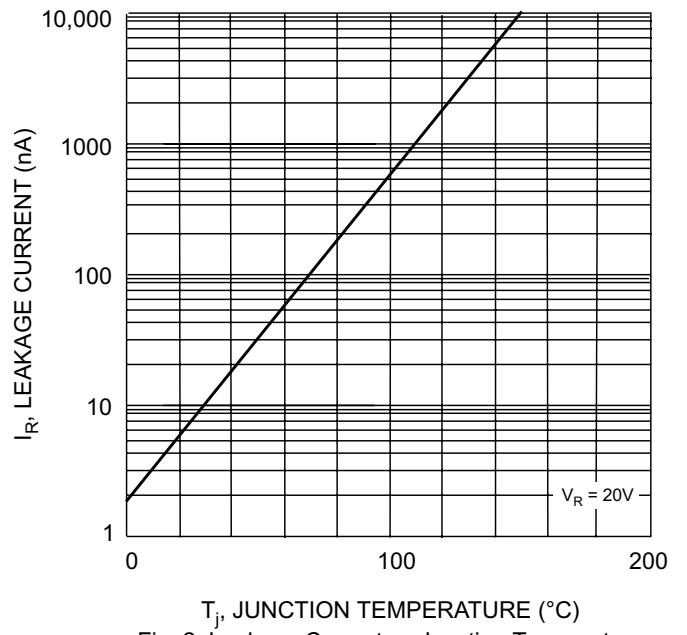

Fig. 2 Leakage Current vs Junction Temperature

## ORDERING INFORMATION

Product No. ♦	Package Type	Shipping Quantity
<b>1N4148WS-T1</b>	SOD-323	5000/Tape & Reel
1N4148WS-T3	SOD-323	10000/Tape & Reel

Products listed in **bold** are WTE **Preferred** devices.

♦T1 suffix refers to a 7" reel. T3 suffix refers to a 13" reel.

Shipping quantity given is for minimum packing quantity only. For minimum order quantity, please consult the Sales Department.

## RECOMMENDED FOOTPRINT

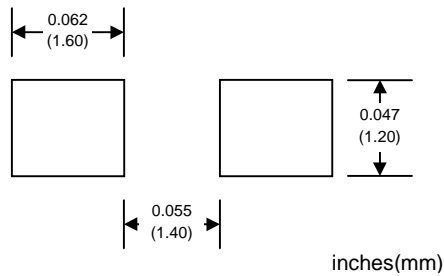

Won-Top Electronics Co., Ltd (WTE) has checked all information carefully and believes it to be correct and accurate. However, WTE cannot assume any responsibility for inaccuracies. Furthermore, this information does not give the purchaser of semiconductor devices any license under patent rights to manufacturer. WTE reserves the right to change any or all information herein without further notice.

**WARNING:** DO NOT USE IN LIFE SUPPORT EQUIPMENT. WTE power semiconductor products are not authorized for use as critical components in life support devices or systems without the express written approval.

**Won-Top Electronics Co., Ltd.**

No. 44 Yu Kang North 3rd Road, Chine Chen Dist., Kaohsiung, Taiwan

**Phone:** 886-7-822-5408 or 886-7-822-5410

**Fax:** 886-7-822-5417

**Email:** sales@wontop.com

**Internet:** <http://www.wontop.com>

*We power your everyday.*