

.156" (3.96mm) Single Row Through Hole, Vertical Headers

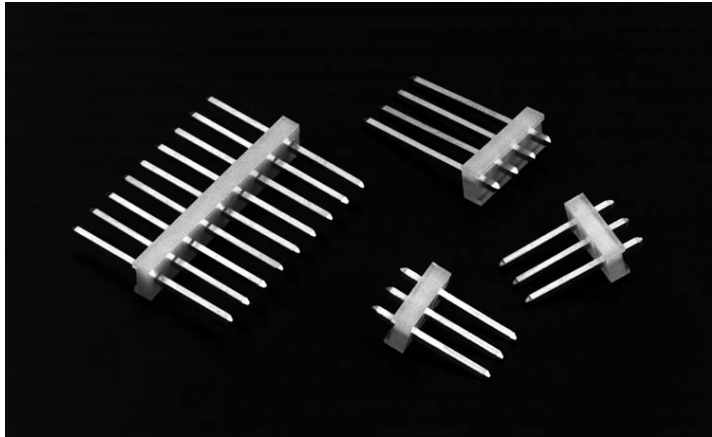

3100 SERIES ("TERMACON")

PART NUMBER LEGEND

31XX-1-XXX-XX

- PIN NUMBER, DIMS "A" & "B" (SEE TABLE II)
- NUMBER OF PINS (SEE TABLE I)
- PIN STYLE: "1" IS .045 SQ., "2" IS .045 RD.
- INSULATOR TYPE (STRAIGHT)
- PIN PLATING (SEE NOTE 3)
- INSULATOR MATERIAL (SEE NOTE 1)

MATING CONNECTORS: 3000 SERIES AND 3300 SERIES CRIMP OR IDC STYLE CONNECTORS

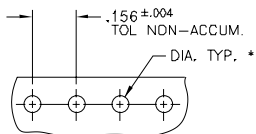
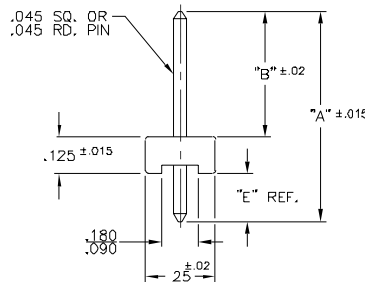
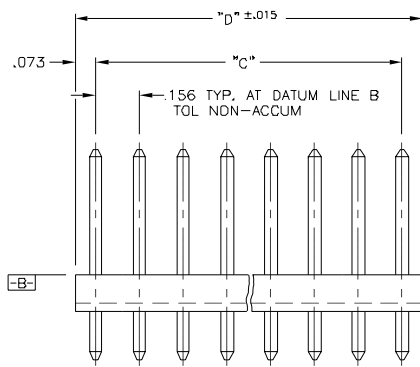

RECOMMENDED P.C. BOARD LAYOUT

- * .060 DIA. FOR .045 RD. PIN
- .070 DIA. FOR .045 SQ. PIN

NOTES:

- 1) INSULATOR MATERIAL: 310X - NYLON 6/6, UL 94V-2, COLOR: WHITE
316X - NYLON 6/6, UL 94V-0, COLOR: WHITE
- 2) PIN MATERIAL: BRASS, ALLOY 260.
- 3) PIN FINISH: 31X0 - BRITE TIN OVER NICKEL PLATE.
31X2 - .000015 GOLD OVER NICKEL PLATE.
31XZ - .000030 GOLD OVER NICKEL PLATE.

PART No.	No. OF POS.	DIM "C"	DIM "D"
31XX-1-X02-XX	2	.156	.302
↑ -X03	3	.312	.458
-X04	4	.468	.614
-X05	5	.624	.770
-X06	6	.780	.926
-X07	7	.936	1.082
-X08	8	1.092	1.238
-X09	9	1.248	1.394
-X10	10	1.404	1.550
-X11	11	1.560	1.706
-X12	12	1.716	1.862
-X13	13	1.872	2.018
-X14	14	2.028	2.174
-X15	15	2.184	2.330
-X16	16	2.340	2.486
-X17	17	2.496	2.642
-X18	18	2.652	2.798
-X19	19	2.808	2.954
-X20	20	2.964	3.110
-X21	21	3.120	3.266
-X22	22	3.276	3.422
↑ -X23	23	3.432	3.578
31XX-1-X24-XX	24	3.588	3.734

PIN No.	DIM "A"	DIM "B"	DIM "E"
-01	.750	.450	.175 REF.
-02	.750	.480	.145 REF.
-03	.812	.560	.127 REF.
-04	.937	.640	.172 REF.
-05	.937	.560	.252 REF.
-06	1.000	.690	.185 REF.
-07	1.187	.890	.172 REF.
-08	1.187	.940	.122 REF.
-09	1.187	.530	.532 REF.
-10	1.250	.450	.675 REF.
-11	1.375	1.080	.170 REF.
-12	1.375	.620	.630 REF.
-13	1.582	.760	.887 REF.
-14	1.582	1.280	.167 REF.
-15	1.582	.620	.817 REF.
-16	1.750	.720	.905 REF.
-19	1.290	1.180	—
-20	1.000	.445	.430 REF.
-21	.937	.625	.187 REF.
-22	.750	.437	.188 REF.
-23	1.812	.950	.737 REF.
-24	1.750	1.25	.375 REF.
-26	.937	.530	.282 REF.
-27	1.400	1.085	.190 REF.
-28	1.125	.825	.175 REF.
-29	1.290	1.055	.110 REF.
-30	1.031	.812	.094 REF.
-31	1.250	.940	.185 REF.
-32	.937	.600	.212 REF.
-33	1.250	1.000	.125 REF.
-34	.937	.375	.437 REF.
-36	1.670	.550	.995 REF.
-39	.812	.480	.207 REF.
-40	.750 REF.	.510	.115 ±.015
-41	1.200	.450	.625 REF.
-42	.812	.530	.157 REF.
-43	.660	.425	.110 REF.
-46	1.750	1.500	.125 REF.

PIN No.	DIM "A"	DIM "B"	DIM "E"
-47	1.560	1.310	.125 REF.
-48	1.031	.450	.456 REF.
-49	2.000	1.750	.125 REF.
-51	1.812	1.562	.125 REF.
-53	1.125	.450	.550 REF.
-54	.750	.390	.235 REF.
-56	1.125 REF.	.890	.115 ±.015
-57	1.400	.637	.638 REF.
-58	1.250	.715	.410 REF.
-60	1.312	1.012	.175 REF.
-67	1.000	.760	.115 REF.
-72	1.000	.720	.155 REF.
-77	1.437	1.137	.175 REF.
-79	1.670	1.370	.175 REF.
-80	1.150	.850	.175 REF.
-81	2.000	1.690	.185 REF.
-82	.625	.382	.118 REF.
-83	1.125	.875	.125 REF.
-84	.937	.690	.122 REF.
-85	.875 REF.	.625 ±.015	.125 ±.015
-86	.690	.450	.115 REF.
-87	.700 REF.	.450 ±.015	.125 ±.015
-88	1.125	.975	.026 REF.
-89	1.100	.590	.385 REF.
-90	1.031	.745	.161 REF.
-91	1.400	1.130	.145 REF.
-92	.700	.400	.175 REF.
-93	1.880	1.550	.205 REF.
-94	.812	.640	.047 REF.
-95	.750	.312	.312 REF.
-96	.812	.687	—
-97	1.800	1.565	.110 REF.
-98	1.000 REF.	.435	.440 ±.015
-99	.812 REF.	.605	.082 REF.
-100	1.812	.950	.737 REF.
-101	.937	.675	.137 REF.



North and South America:

Methode Electronics, Inc. Connector Products

1700 Hicks Road • Rolling Meadows, IL 60008 USA

847-392-3500 • Toll Free: 800-323-6864 • Fax: 847-392-9404

Email: info@methode.com • Web: www.methode.com/connector/index.html

Europe:

Methode Electronics Ireland, Ltd.

Unit H, Crossagalla Business Park, Ballysimon Rd. • Limerick, Ireland

+353 (0) 61 401222 • Fax: +353 (0) 61 401942

Email: info@methode.ie • Web: ireland.methode.com/main.html

Far East:

Methode Electronics Far East, Pte. Ltd.

1 Tuas Lane, Jurong Town • Singapore 638610

65-68615444 • Fax: 65-68614777

Email: sales@methode.com.sg • Web: www.methode.com/mefe/index.html

.156" (3.96mm) Single Row, Through Hole, Right Angle, Bottom Polarizing Headers

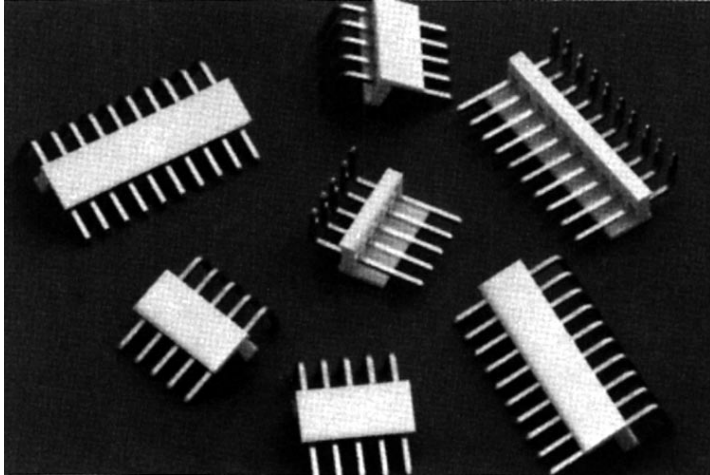

3100 SERIES ("TERMACON")

PART NUMBER LEGEND

310X-10-1XX-XX

PIN NUMBER (SEE TABLE II)

NUMBER OF POSITIONS (SEE TABLE I)

PIN PLATING (SEE NOTE 2)

MATING CONNECTORS: 3000 SERIES AND 3300 SERIES CRIMP OR IDC STYLE CONNECTORS

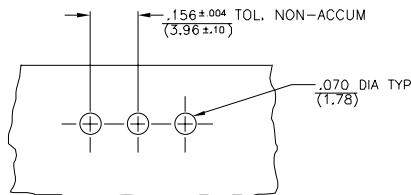
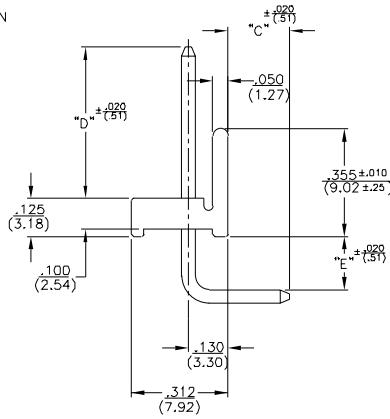
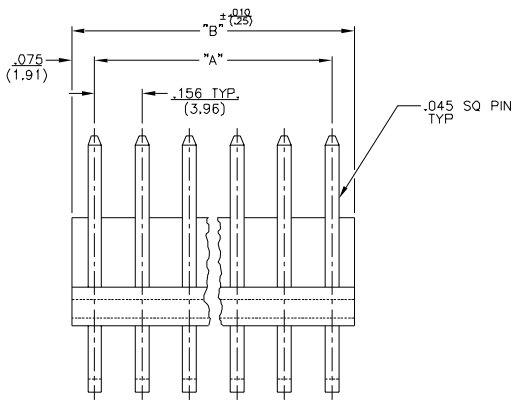
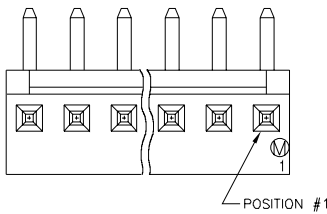

RECOMMENDED P.C. BOARD LAYOUT

NOTES:

- 1) MATERIAL: POLYESTER UL 94V-0
- 2) CONTACT FINISH: 310Q-TIN OVER NICKEL PLATE
3102-.00015 GOLD PLATE OVER
.000030 NICKEL PLATE

TABLE I			
PART No.	No. of POS	DIM "A"	DIM "B"
310X-10-102-XX	2	.156/(3.96)	.302/(7.67)
↑ -103- ↓	3	.312/(7.92)	.458/(11.63)
-104-	4	.468/(11.89)	.614/(15.60)
-105-	5	.624/(15.85)	.770/(19.56)
-106-	6	.780/(19.81)	.926/(23.52)
-107-	7	.936/(23.77)	1.082/(27.48)
-108-	8	1.092/(27.74)	1.238/(31.45)
-109-	9	1.248/(31.70)	1.394/(35.41)
-110-	10	1.404/(35.66)	1.550/(39.37)
-111-	11	1.560/(39.62)	1.706/(43.33)
-112-	12	1.716/(43.59)	1.862/(47.29)
-113-	13	1.872/(47.55)	2.018/(51.26)
-114-	14	2.028/(51.51)	2.174/(55.22)
-115-	15	2.184/(55.47)	2.330/(59.18)
-116-	16	2.340/(59.45)	2.486/(63.14)
-117-	17	2.496/(63.40)	2.642/(67.11)
-118-	18	2.652/(67.36)	2.798/(71.07)
-119-	19	2.808/(71.32)	2.954/(75.03)
-120-	20	2.964/(75.29)	3.110/(78.99)
-121-	21	3.120/(79.25)	3.266/(82.96)
-122-	22	3.276/(83.21)	3.422/(86.92)
-123- ↓	23	3.432/(87.17)	3.578/(90.88)
310X-10-124-XX	24	3.588/(91.14)	3.734/(94.84)

TABLE II			
PIN.No	DIM "C"	DIM "D"	DIM "E"
61	.170/(4.32)	.45/(11.43)	.125/(3.18)
62	.110/(2.79)	.79/(20.07)	.200/(5.08)



North and South America:

Methode Electronics, Inc. Connector Products

1700 Hicks Road • Rolling Meadows, IL 60008 USA

847-392-3500 • Toll Free: 800-323-6864 • Fax: 847-392-9404

Email: info@methode.com • Web: www.methode.com/connector/index.html

Europe:

Methode Electronics Ireland, Ltd.

Unit H, Crossagalla Business Park, Ballysimon Rd. • Limerick, Ireland

+353 (0) 61 401222 • Fax: +353 (0) 61 401942

Email: info@methode.ie • Web: ireland.methode.com/main.html

Far East:

Methode Electronics Far East, Pte. Ltd.

1 Tuas Lane, Jurong Town • Singapore 638610

65-68615444 • Fax: 65-68614777

Email: sales@methode.com.sg • Web: www.methode.com/mefe/index.html

.156" (3.96mm) Single Row Through Hole, Vertical Polarizing Headers

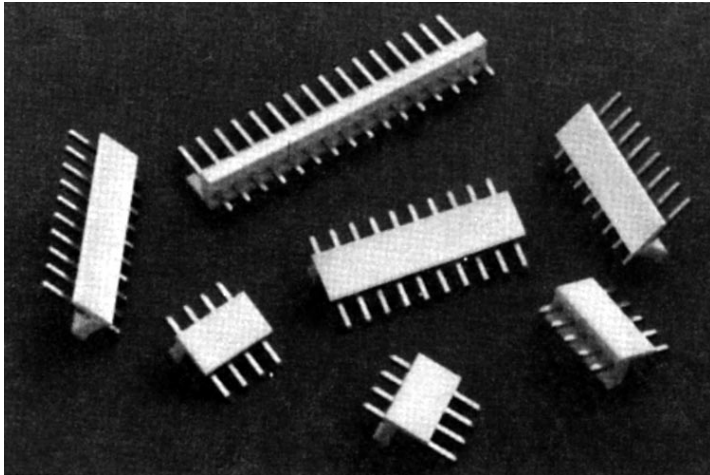

3100 SERIES ("TERMACON")

PART NUMBER LEGEND

310X-11-XXX-XX

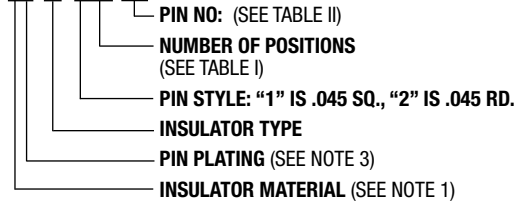

MATING CONNECTORS: 3000 SERIES AND 3300 SERIES CRIMP OR IDC STYLE CONNECTORS

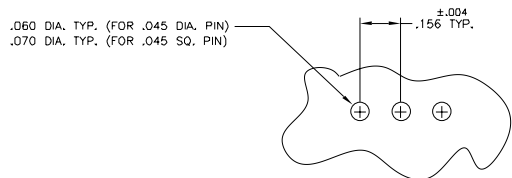
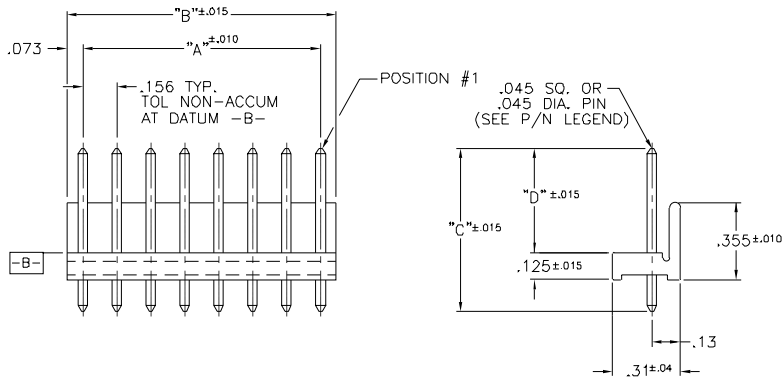

RECOMMENDED P.C. BOARD LAYOUT

NOTES:

- 1) INSULATOR MATERIAL: 310X - POLYESTER, UL 94V-0, COLOR: WHITE
- 2) PIN MATERIAL: BRASS
- 3) PIN FINISH: 31X0 - BRITTE TIN OVER NICKEL PLATE. (-205)
31X2 - .000015 GOLD OVER NICKEL PLATE. (-002)
31X2 - .000030 GOLD OVER NICKEL PLATE. (-007)

PART No.	No. OF POS.	DIM "A"	DIM "B"
310X-11-X02-XX	2	.156	.302
↑ -X03 ↑	3	.312	.458
↑ -X04 ↑	4	.468	.614
↑ -X05 ↑	5	.624	.770
↑ -X06 ↑	6	.780	.926
↑ -X07 ↑	7	.936	1.082
↑ -X08 ↑	8	1.092	1.238
↑ -X09 ↑	9	1.248	1.394
↑ -X10 ↑	10	1.404	1.550
↑ -X11 ↑	11	1.560	1.706
↑ -X12 ↑	12	1.716	1.862
↑ -X13 ↑	13	1.872	2.018
↑ -X14 ↑	14	2.028	2.174
↑ -X15 ↑	15	2.184	2.330
↑ -X16 ↑	16	2.340	2.486
↑ -X17 ↑	17	2.496	2.642
↑ -X18 ↑	18	2.652	2.798
↑ -X19 ↑	19	2.808	2.954
↑ -X20 ↑	20	2.964	3.110
↑ -X21 ↑	21	3.120	3.266
↑ -X22 ↑	22	3.276	3.422
↑ -X23 ↑	23	3.432	3.578
310X-11-X24-XX	24	3.588	3.734

PIN No.	DIM "C"	DIM "D"
-01	.750	.450
-02	.750	.480
-03	.812	.560
-04	.937	.640
-05	.937	.560
-06	1.000	.690
-07	1.187	.890
-08	1.187	.940
-09	1.187	.530
-10	1.250	.450
-11	1.375	1.080
-12	1.375	.620
-13	1.562	.750
-14	1.562	1.280
-15	1.562	.620
-16	1.750	.720
-19	1.290	1.180
-20	1.000	.445

PIN No.	DIM "C"	DIM "D"
-21	.937	.625
-22	.750	.437
-23	1.812	.950
-24	1.750	1.250
-26	.937	.530
-27	1.400	1.085
-28	1.125	.825
-29	1.290	1.055
-30	1.031	.812
-31	1.250	.940
-32	.937	.600
-33	1.250	1.000
-34	.937	.375
-36	1.670	.560
-39	.812	.480
-40	.750	.500
-41	1.200	.450
-42	.812	.530
-43	.660	.425
-46	1.750	1.500

PIN No.	DIM "C"	DIM "D"
-47	1.560	1.310
-48	1.031	.450
-49	2.000	1.750
-51	1.812	1.562
-53	1.125	.450
-54	.750	.390
-56	1.125	.900
-57	1.400	.637
-58	1.250	.715
-60	1.312	1.012
-67	1.000	.760
-72	1.000	.720
-77	1.437	1.137
-79	1.670	1.370
-80	1.150	.850
-81	2.000	1.690



North and South America:
Methode Electronics, Inc. Connector Products
 1700 Hicks Road • Rolling Meadows, IL 60008 USA
 847-392-3500 • Toll Free: 800-323-6864 • Fax: 847-392-9404
 Email: info@methode.com • Web: www.methode.com/connector/index.html

Europe:
Methode Electronics Ireland, Ltd.
 Unit H, Crossagalla Business Park, Ballysimon Rd. • Limerick, Ireland
 +353 (0) 61 401222 • Fax: +353 (0) 61 401942
 Email: info@methode.ie • Web: ireland.methode.com/main.html

Far East:
Methode Electronics Far East, Pte. Ltd.
 1 Tuas Lane, Jurong Town • Singapore 638610
 65-68615444 • Fax: 65-68614777
 Email: sales@methode.com.sg • Web: www.methode.com/mefe/index.html

.156" (3.96mm) Single Row, Through Hole, Right Angle, Bottom Polarizing, Locking Headers

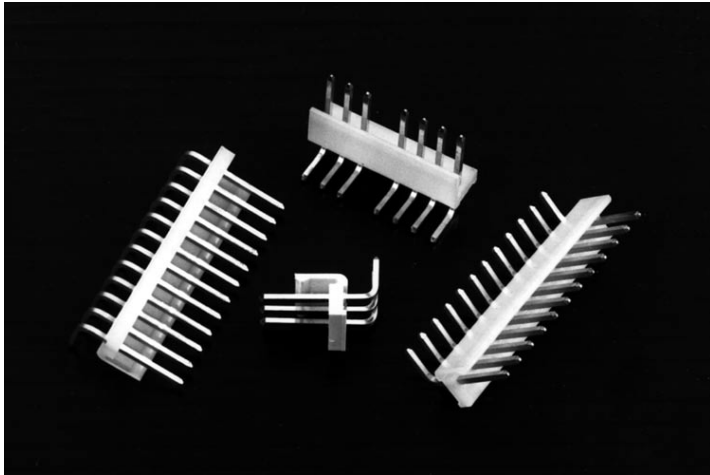

3100 SERIES ("TERMACON")

PART NUMBER LEGEND

310X-12-1XX-XX

- PIN NUMBER A & B: (SEE TABLE II)
- NUMBER OF POSITIONS (SEE TABLE I)
- INSULATOR TYPE
- PIN PLATING (SEE NOTE 2)
- INSULATOR MATERIAL (SEE NOTE 1)

MATING CONNECTORS: 3000 SERIES AND 3300 SERIES CRIMP OR IDC STYLE CONNECTORS

NOTES:

1) INSULATOR MATERIAL: 310X-9-1XX-XX: NYLON 6/6 94V-2
 316X-9-1XX-XX: NYLON 6/6 94V-0
 CONTACT-70/30 BRASS

2) CONTACT FINISH: 31X0-TIN OVER NICKEL PLATE
 31X2-.000015 GOLD PL OVER NICKEL
 31XZ-.000030 GOLD PL OVER NICKEL

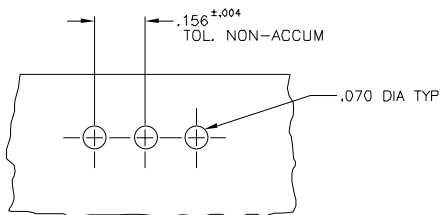
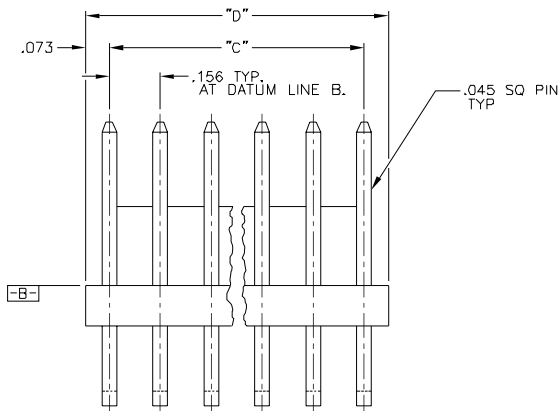
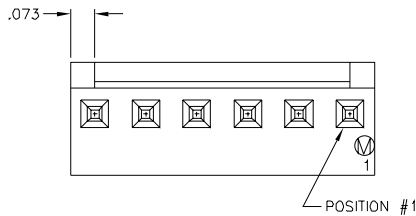

RECOMMENDED P.C. BOARD LAYOUT

PART No.	No. OF POS	DIM "C"	DIM "D"
31XX-12-102-XX	2	.156	.306
↑ -103- ↑	3	.312	.462
-104-	4	.468	.618
-105-	5	.624	.774
-106-	6	.780	.930
-107-	7	.936	1.086
-108-	8	1.092	1.242
-109-	9	1.248	1.398
-110-	10	1.404	1.554
-111-	11	1.560	1.710
-112-	12	1.716	1.866
-113-	13	1.872	2.022
-114-	14	2.028	2.178
-115-	15	2.184	2.334
-116-	16	2.340	2.490
-117-	17	2.496	2.646
-118-	18	2.652	2.802
-119-	19	2.808	2.958
-120-	20	2.964	3.114
-121-	21	3.120	3.270
-122-	22	3.276	3.426
↓ -123- ↓	23	3.432	3.582
31XX-12-124-XX	24	3.588	3.734

PIN.No	DIM "A"	DIM "B"
45	.170	.310
46	.170	.265



North and South America:

Methode Electronics, Inc. Connector Products

1700 Hicks Road • Rolling Meadows, IL 60008 USA

847-392-3500 • Toll Free: 800-323-6864 • Fax: 847-392-9404

Email: info@methode.com • Web: www.methode.com/connector/index.html

Europe:

Methode Electronics Ireland, Ltd.

Unit H, Crossagalla Business Park, Ballysimon Rd. • Limerick, Ireland

+353 (0) 61 401222 • Fax: +353 (0) 61 401942

Email: info@methode.ie • Web: ireland.methode.com/main.html

Far East:

Methode Electronics Far East, Pte. Ltd.

1 Tuas Lane, Jurong Town • Singapore 638610

65-68615444 • Fax: 65-68614777

Email: sales@methode.com.sg • Web: www.methode.com/mefe/index.html

.156" (3.96mm) Single Row, Through Hole, Right Angle Headers

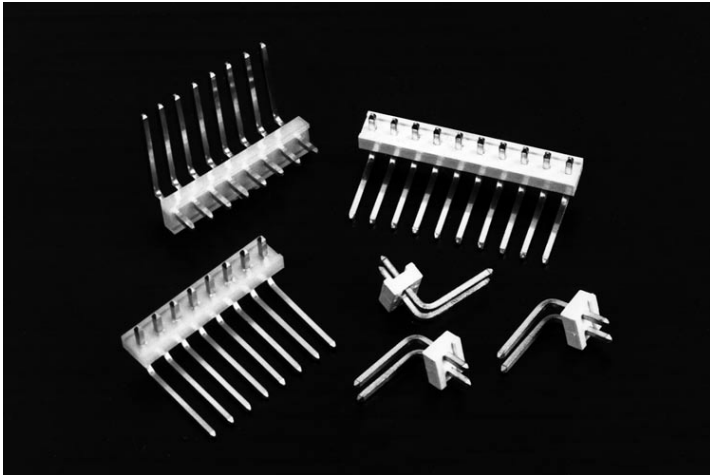

3100 SERIES ("TERMACON")

PART NUMBER LEGEND

31XX-3-1XX-XX

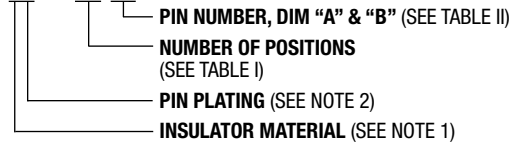

MATING CONNECTORS: 3000 SERIES AND 3300 SERIES CRIMP OR IDC STYLE CONNECTORS

NOTES:

- INSULATOR MATERIAL:
 31QX: NYLON 6/6, UL 94V-2
 316X: NYLON 6/6, UL 94V-0
 PIN MATERIAL 70/30 BRASS
- PIN FINISH: 31X0- TIN OVER NICKEL PLATE
 31X2- .000015 GOLD PLATE OVER NICKEL PLATE
 31X7- .000030 GOLD PLATE OVER NICKEL PLATE

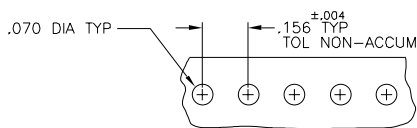
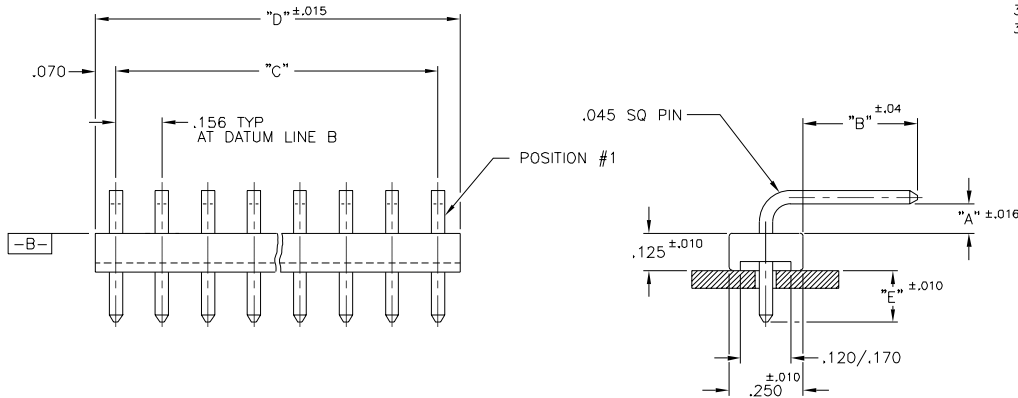

RECOMMENDED P.C. BOARD LAYOUT

PART No.	No. OF POSITIONS	DIM "C"	DIM "D"
31XX-3-102-XX	2	.156	.296
↑ -103- ↓	3	.312	.452
↑ -104- ↓	4	.468	.608
↑ -105- ↓	5	.624	.764
↑ -106- ↓	6	.780	.920
↑ -107- ↓	7	.936	1.076
↑ -108- ↓	8	1.092	1.232
↑ -109- ↓	9	1.248	1.388
↑ -110- ↓	10	1.404	1.544
↑ -111- ↓	11	1.560	1.700
↑ -112- ↓	12	1.716	1.856
↑ -113- ↓	13	1.872	2.012
↑ -114- ↓	14	2.028	2.168
↑ -115- ↓	15	2.184	2.324
↑ -116- ↓	16	2.340	2.480
↑ -117- ↓	17	2.496	2.636
↑ -118- ↓	18	2.652	2.792
↑ -119- ↓	19	2.808	2.948
↑ -120- ↓	20	2.964	3.104
↑ -121- ↓	21	3.120	3.260
↑ -122- ↓	22	3.276	3.416
↑ -123- ↓	23	3.432	3.572
31XX-3-124-XX	24	3.588	3.728

PIN No.	DIM "A"	DIM "B"	DIM "E"
17	.172	.46	.171
18	.700	.49	.144
25	.172	.625	.162
38	.170	.180	.172
50	.090	.450	.169
52	.190	.360	.159
59	.105	.130	.300
63	.140	.739	.162
64	.172	1.00	.171
65	.172	.750	.171
68	.172	.360	.180
69	.110	.547	.547
70	.110 ±.010	.365 ±.015	.156
71	.250	.460	.156
73	.352	1.085	.156
74	.172	.850	.156
75	.078	.200 ±.020	.200
76	.078 ±.005	.510 ±.010	.175 ±.005
78	.295	.460	.171
79	.172	.350	.110
80	.700	.300	.144
81	.172	.450 ±.015	.125
82	.09	.700	.156
83	.090	.144	.144
84	.078	.390	.175
85	.172	.460	.112
86	.172	.490	.155



North and South America:
Methode Electronics, Inc. Connector Products
 1700 Hicks Road • Rolling Meadows, IL 60008 USA
 847-392-3500 • Toll Free: 800-323-6864 • Fax: 847-392-9404
 Email: info@methode.com • Web: www.methode.com/connector/index.html

Europe:
Methode Electronics Ireland, Ltd.
 Unit H, Crossagalla Business Park, Ballysimon Rd. • Limerick, Ireland
 +353 (0) 61 401222 • Fax: +353 (0) 61 401942
 Email: info@methode.ie • Web: ireland.methode.com/main.html

Far East:
Methode Electronics Far East, Pte. Ltd.
 1 Tuas Lane, Jurong Town • Singapore 638610
 65-68615444 • Fax: 65-68614777
 Email: sales@methode.com.sg • Web: www.methode.com/mefe/index.html

.156" (3.96mm) Single Row, Through Hole, Right Angle, Top Polarizing Headers

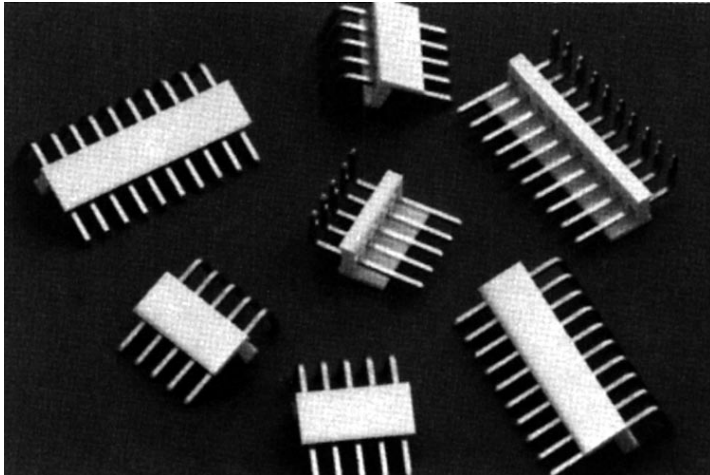

3100 SERIES ("TERMACON")

PART NUMBER LEGEND

310X-7-1XX-XX

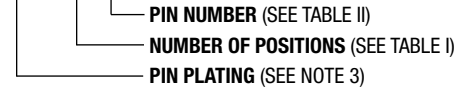

MATING CONNECTORS: 3000 SERIES AND 3300 SERIES CRIMP OR IDC STYLE CONNECTORS

NOTES:

- 1) INSULATOR MATERIAL: POLYESTER UL 94V-0
- 2) CONTACT MATERIAL: 70/30 BRASS
- 3) CONTACT FINISH: 310Q-TIN/LEAD OVER NICKEL PLATE
3102-,.000015 GOLD PLATE OVER
.000030 NICKEL PLATE

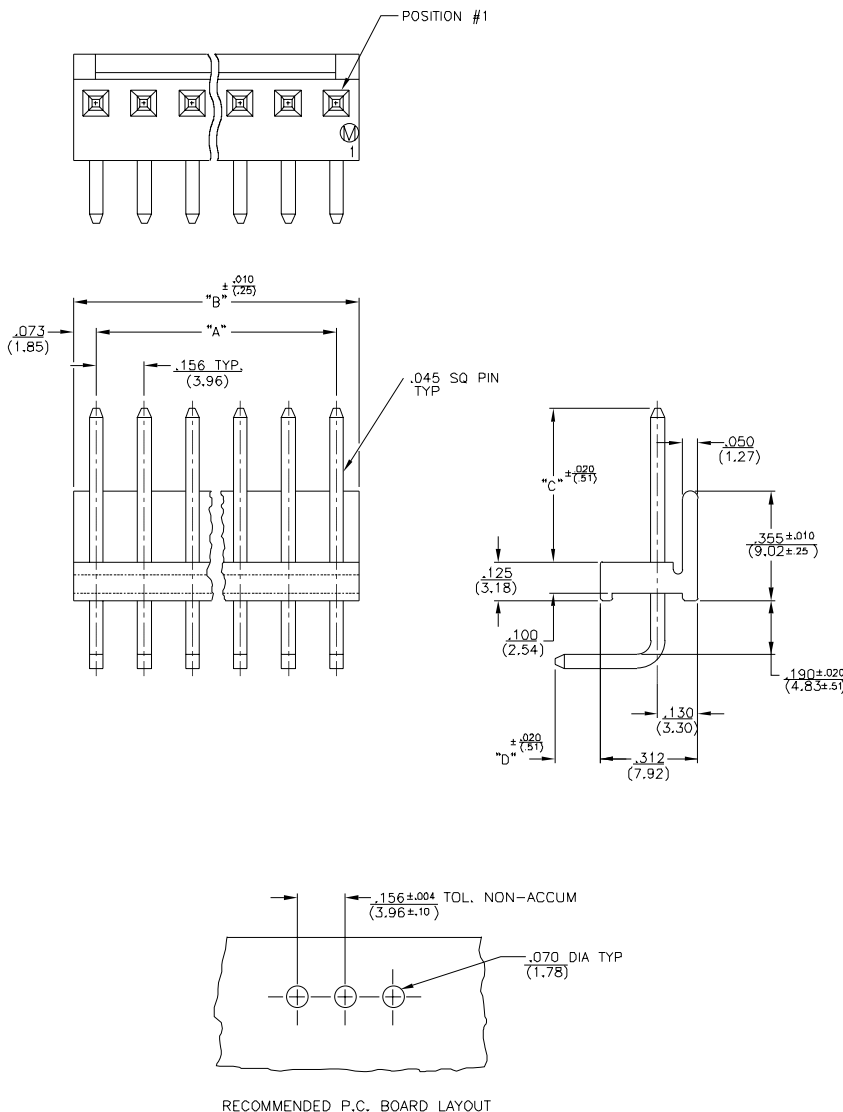

TABLE I			
PART No.	No. of POS	DIM "A"	DIM "B"
310X-7-102-XX	2	.156/(3.96)	.302/(7.67)
-103-	3	.312/(7.92)	.458/(11.63)
-104-	4	.468/(11.89)	.614/(15.60)
-105-	5	.624/(15.85)	.770/(19.56)
-106-	6	.780/(19.81)	.926/(23.52)
-107-	7	.936/(23.77)	1.082/(27.48)
-108-	8	1.092/(27.74)	1.238/(31.45)
-109-	9	1.248/(31.70)	1.394/(35.41)
-110-	10	1.404/(35.66)	1.550/(39.37)
-111-	11	1.560/(39.62)	1.706/(43.33)
-112-	12	1.716/(43.59)	1.862/(47.29)
-113-	13	1.872/(47.55)	2.018/(51.26)
-114-	14	2.028/(51.51)	2.174/(55.22)
-115-	15	2.184/(55.47)	2.330/(59.18)
-116-	16	2.340/(59.45)	2.486/(63.14)
-117-	17	2.496/(63.40)	2.642/(67.11)
-118-	18	2.652/(67.36)	2.798/(71.07)
-119-	19	2.808/(71.32)	2.954/(75.03)
-120-	20	2.964/(75.29)	3.110/(78.99)
-121-	21	3.120/(79.25)	3.266/(82.96)
-122-	22	3.276/(83.21)	3.422/(86.92)
-123-	23	3.432/(87.17)	3.578/(90.88)
310X-7-124-XX	24	3.588/(91.14)	3.734/(94.84)

TABLE II		
PART NO.	DIM "C"	DIM "D"
310X-7-1XX-01	.50/(12.7)	.170/(4.32)
310X-7-1XX-02	.75/(19.1)	.170/(4.32)
310X-7-1XX-03	.50/(12.7)	.130/(3.30)



North and South America:
Methode Electronics, Inc. Connector Products
 1700 Hicks Road • Rolling Meadows, IL 60008 USA
 847-392-3500 • Toll Free: 800-323-6864 • Fax: 847-392-9404
 Email: info@methode.com • Web: www.methode.com/connector/index.html

Europe:
Methode Electronics Ireland, Ltd.
 Unit H, Crossagalla Business Park, Ballysimon Rd. • Limerick, Ireland
 +353 (0) 61 401222 • Fax: +353 (0) 61 401942
 Email: info@methode.ie • Web: ireland.methode.com/main.html

Far East:
Methode Electronics Far East, Pte. Ltd.
 1 Tuas Lane, Jurong Town • Singapore 638610
 65-68615444 • Fax: 65-68614777
 Email: sales@methode.com.sg • Web: www.methode.com/mefe/index.html

.156" (3.96mm) Single Row, Through Hole Vertical Polarizing & Locking Headers

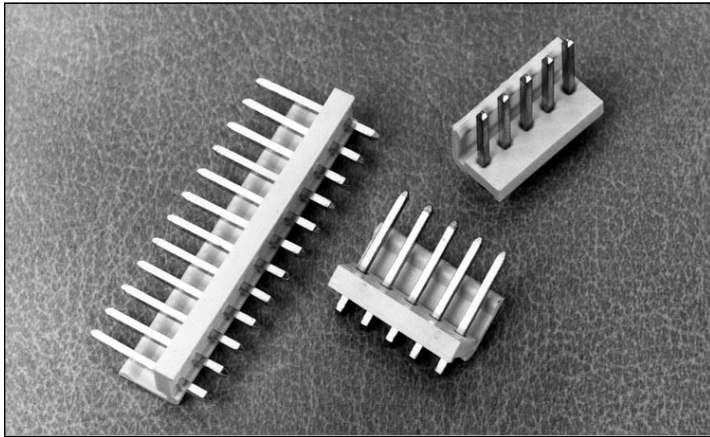

3100 SERIES ("TERMACON")

PART NUMBER LEGEND

31XX-8-XXX-XX

- PIN NUMBER (SEE TABLE II)
- NUMBER OF POSITIONS (SEE TABLE I)
- PIN STYLE: "1" IS .045 SQ., "2" IS .045 RD.
- INSULATOR TYPE
- PIN PLATING (SEE NOTE 3)
- INSULATOR MATERIAL (SEE NOTE 1)

MATING CONNECTORS: 3000 SERIES AND 3300 CRIMP OR IDC STYLE CONNECTORS

NOTES:

- 1) INSULATOR MATERIAL: 310X - NYLON 6/6, UL 94V-2, COLOR: WHITE
316X - NYLON 6/6, UL 94V-0, COLOR: WHITE
- 2) PIN MATERIAL: 70/30 BRASS
- 3) PIN FINISH: 31X0 - BRITE TIN OVER NICKEL PLATE. (-205)
31X2 - .000015 GOLD OVER NICKEL PLATE. (-002)
31XZ - .000030 GOLD OVER NICKEL PLATE. (-007)

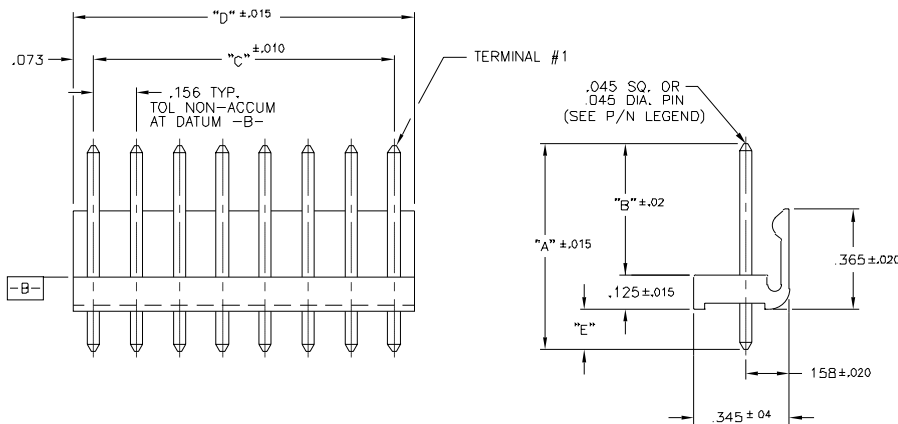

*.060 DIA. TYP. (FOR .045 DIA. PIN)
070 DIA. TYP. (FOR .045 SQ. PIN)

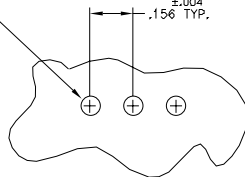

RECOMMENDED P.C. BOARD LAYOUT

PART No.	No. OF POS.	DIM "C"	DIM "D"
31XX-8-X02-XX	2	.156	.302
-X03	3	.312	.458
-X04	4	.468	.614
-X05	5	.624	.770
-X06	6	.780	.926
-X07	7	.936	1.082
-X08	8	1.092	1.238
-X09	9	1.248	1.394
-X10	10	1.404	1.550
-X11	11	1.560	1.706
-X12	12	1.716	1.862
-X13	13	1.872	2.018
-X14	14	2.028	2.174
-X15	15	2.184	2.330
-X16	16	2.340	2.486
-X17	17	2.496	2.642
-X18	18	2.652	2.798
-X19	19	2.808	2.954
-X20	20	2.964	3.110
-X21	21	3.120	3.266
-X22	22	3.276	3.422
-X23	23	3.432	3.578
31XX-8-X24-XX	24	3.588	3.734

PART NUMBER	POS. # OMITTED
3160821501-OMIT,A	2, 6, 8, 10, 12, 14

PIN No.	DIM "A"	DIM "B"	DIM "E"
-01	.750	.450	.175 REF.
-02	.750	.480	.145 REF.
-03	.812	.560	.127 REF.
-04	.937	.640	.172 REF.
-05	.937	.560	.252 REF.
-06	1.000	.690	.185 REF.
-07	1.187	.890	.172 REF.
-08	1.187	.940	.122 REF.
-09	1.187	.530	.532 REF.
-10	1.250	.450	.675 REF.
-11	1.375	1.080	.170 REF.
-12	1.375	.620	.630 REF.
-13	1.562	.750	.687 REF.
-14	1.562	1.280	.157 REF.
-15	1.562	.620	.817 REF.
-16	1.750	.720	.905 REF.
-19	1.290	1.180	
-20	1.000	.445	.430 REF.

PIN No.	DIM "A"	DIM "B"	DIM "E"
-21	.937	.625	.187 REF.
-22	.750	.437	.188 REF.
-23	1.812	.950	.862 REF.
-24	1.750	1.250	.375 REF.
-26	.937	.530	.282 REF.
-27	1.400	1.085	.190 REF.
-28	1.125	.825	.175 REF.
-29	1.290	1.055	.110 REF.
-30	1.031	.812	.094 REF.
-31	1.250	.940	.185 REF.
-32	.937	.600	.212 REF.
-33	1.250	1.000	.125 REF.
-34	.937	.375	.437 REF.
-36	1.670	.550	.995 REF.
-39	.812	.480	.687 REF.
-40	.750	.500	.125 REF.
-41	1.200	.450	.625 REF.
-42	.812	.530	.157 REF.
-43	.660	.425	.110 REF.
-46	1.750	1.500	.125 REF.

PIN No.	DIM "A"	DIM "B"	DIM "E"
-47	1.560	1.310	.125 REF.
-48	1.031	.450	.456 REF.
-49	2.000	1.750	.125 REF.
-51	1.812	1.562	.125 REF.
-53	1.125	.450	.550 REF.
-54	.750	.390	.235 REF.
-56	1.125	.900	.100 REF.
-57	1.400	.637	.638 REF.
-58	1.250	.715	.410 REF.
-60	1.312	1.012	.175 REF.
-67	1.000	.760	.115 REF.
-72	1.000	.720	.155 REF.
-77	1.437	1.137	.175 REF.
-79	1.670	1.370	.175 REF.
-80	1.150	.850	.175 REF.
-81	2.000	1.690	.185 REF.
-86	.690	.450	.115 REF.
-87	700 REF.	450 ±.015	.125 ±.015
-88	660 REF.	450	.079 ±.006
-89	.660	.410	.125 REF.



North and South America:

Methode Electronics, Inc. Connector Products

1700 Hicks Road • Rolling Meadows, IL 60008 USA

847-392-3500 • Toll Free: 800-323-6864 • Fax: 847-392-9404

Email: info@methode.com • Web: www.methode.com/connector/index.html

Europe:

Methode Electronics Ireland, Ltd.

Unit H, Crossagalla Business Park, Ballysimon Rd. • Limerick, Ireland

+353 (0) 61 401222 • Fax: +353 (0) 61 401942

Email: info@methode.ie • Web: ireland.methode.com/main.html

Far East:

Methode Electronics Far East, Pte. Ltd.

1 Tuas Lane, Jurong Town • Singapore 638610

65-68615444 • Fax: 65-68614777

Email: sales@methode.com.sg • Web: www.methode.com/mefe/index.html

.156" (3.96mm) Single Row, Through Hole, Right Angle, Top Polarizing, Locking Headers

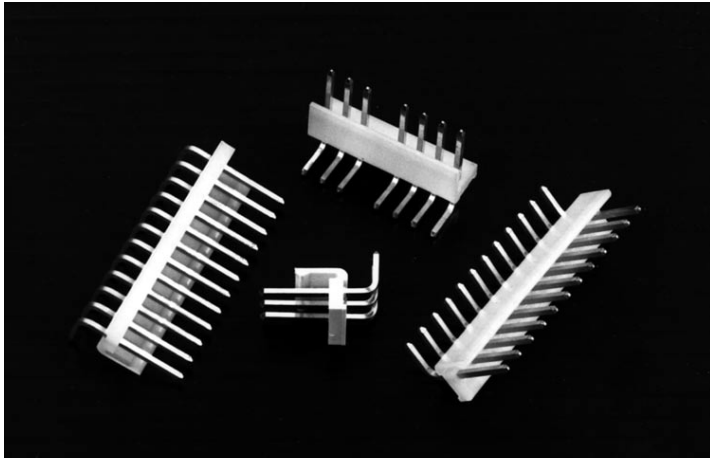

3100 SERIES ("TERMACON")

PART NUMBER LEGEND

31XX-9-1XX-XX

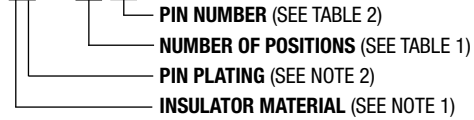

MATING CONNECTORS: 3000 SERIES AND 3300 SERIES CRIMP OR IDC STYLE CONNECTORS

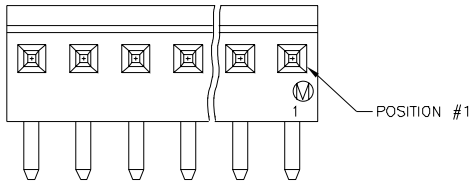

NOTES:

1) INSULATOR MATERIAL:

310X-9-1XX-XX : NYLON 6/6, UL 94V-2.

316X-9-1XX-XX : NYLON 6/6, UL 94V-0.

CONTACT MATERIAL: 70/30 BRASS

2) PIN FINISH: 310X-9-1XX-XX : BRITE TIN PLATE OVER NICKEL PLATE.

31X2-9-1XX-XX : .000015 GOLD PLATE OVER .000050 NICKEL PLATE.

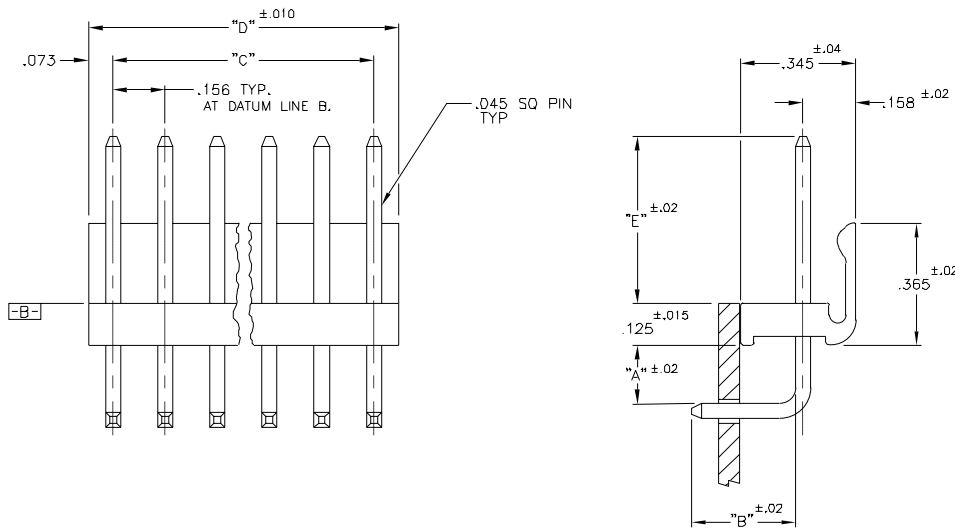

PART No.	DIM "A"	DIM "B"	DIM "E"
31XX-9-1XX-35	.190	.730	.50
↑ -37 ↑	.190	.360	.50
↑ -44 ↑	.172	.460	.50
↑ -55 ↑	.190	.310	.50
↑ -66 ↑	.190	.275	.52
↑ -82 ↑	.090	.200	.50
↑ -83 ↑	.190 ±.015	.290 ±.015	.450 ±.015
↑ -89 ↑	.090	.280	.50
↑ -90 ↑	.190	.340 ±.010	.450
↑ -91 ↑	.190	.250	.500
↓ 31XX-9-1XX-92 ↓	.190	.350	.510

PART No.	No. OF POS	DIM "C"	DIM "D"
31XX-39-102-XX	2	.156	.302
↑ -103- ↑	3	.312	.458
↑ -104- ↑	4	.468	.614
↑ -105- ↑	5	.624	.770
↑ -106- ↑	6	.780	.926
↑ -107- ↑	7	.936	1.082
↑ -108- ↑	8	1.092	1.238
↑ -109- ↑	9	1.248	1.394
↑ -110- ↑	10	1.404	1.550
↑ -111- ↑	11	1.560	1.706
↑ -112- ↑	12	1.716	1.862
↑ -113- ↑	13	1.872	2.018
↑ -114- ↑	14	2.028	2.174
↑ -115- ↑	15	2.184	2.330
↑ -116- ↑	16	2.340	2.486
↑ -117- ↑	17	2.496	2.642
↑ -118- ↑	18	2.652	2.798
↑ -119- ↑	19	2.808	2.954
↑ -120- ↑	20	2.964	3.110
↑ -121- ↑	21	3.120	3.266
↑ -122- ↑	22	3.276	3.422
↑ -123- ↑	23	3.432	3.578
↓ 31XX-39-124-XX ↓	24	3.588	3.734

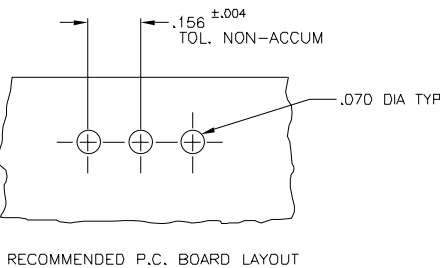

North and South America:

Methode Electronics, Inc. Connector Products

1700 Hicks Road • Rolling Meadows, IL 60008 USA

847-392-3500 • Toll Free: 800-323-6864 • Fax: 847-392-9404

Email: info@methode.com • Web: www.methode.com/connector/index.html

Europe:

Methode Electronics Ireland, Ltd.

Unit H, Crossagalla Business Park, Ballysimon Rd. • Limerick, Ireland

+353 (0) 61 401222 • Fax: +353 (0) 61 401942

Email: info@methode.ie • Web: ireland.methode.com/main.html

Far East:

Methode Electronics Far East, Pte. Ltd.

1 Tuas Lane, Jurong Town • Singapore 638610

65-68615444 • Fax: 65-68614777

Email: sales@methode.com.sg • Web: www.methode.com/mefe/index.html

.156" (3.96mm) Custom Double Headers

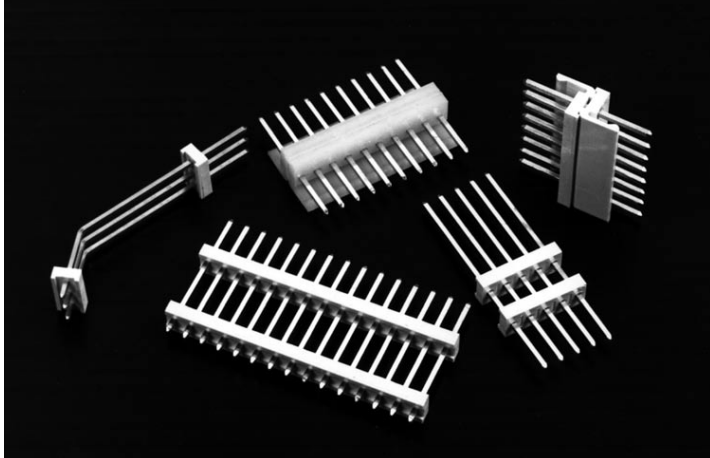

3100 SERIES ("TERMACON")

PART NUMBER LEGEND

316X-14-1XX-XXX

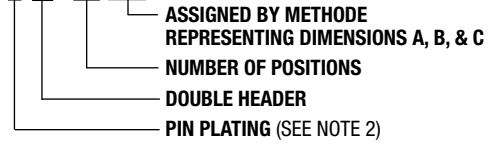

MATING CONNECTORS: 3000 SERIES

NOTES:

- INSULATOR MATERIAL: NYLON 6/6, UL 94V-0
CONTACT MATERIAL: 70/30 BRASS
- CONTACT FINISH:
316Q - TIN PLATE OVER NICKEL
316Z - .000015 GOLD PLATE OVER NICKEL
316Z - .000030 GOLD PLATE OVER NICKEL

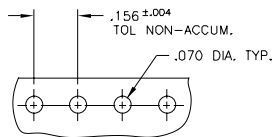
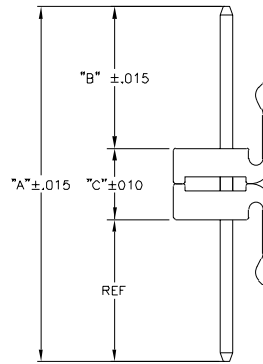
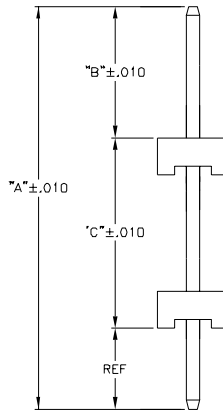
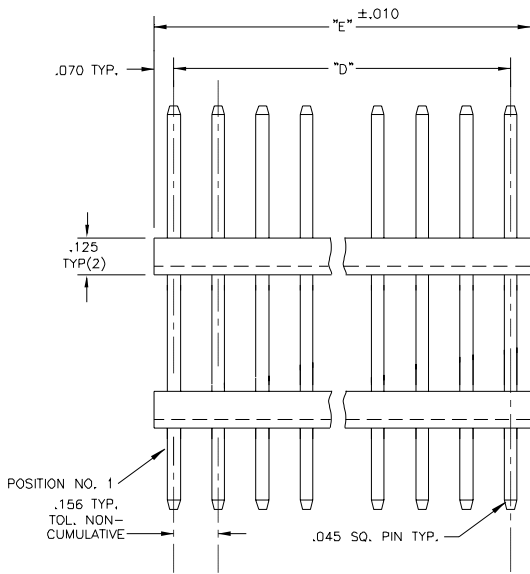

RECOMMENDED P.C. BOARD LAYOUT

PART NO.	NO. OF POS.	DIM. "D"	DIM. "E"
316X-14-102-XXX	2	.156	.296
↑ -103- ↑	3	.312	.452
↑ -104- ↑	4	.468	.608
↑ -105- ↑	5	.624	.764
↑ -106- ↑	6	.780	.920
↑ -107- ↑	7	.936	1.076
↑ -108- ↑	8	1.092	1.232
↑ -109- ↑	9	1.248	1.388
↑ -110- ↑	10	1.404	1.544
↑ -111- ↑	11	1.560	1.700
↑ -112- ↑	12	1.716	1.856
↑ -113- ↑	13	1.872	2.012
↑ -114- ↑	14	2.028	2.168
↑ -115- ↑	15	2.184	2.324
↑ -116- ↑	16	2.340	2.480
↑ -117- ↑	17	2.496	2.636
↑ -118- ↑	18	2.652	2.792
↑ -119- ↑	19	2.808	2.948
↑ -120- ↑	20	2.964	3.104
↑ -121- ↑	21	3.120	3.260
↑ -122- ↑	22	3.276	3.416
↑ -123- ↑	23	3.432	3.572
↑ 316X-14-124-XXX ↑	24	3.588	3.728



North and South America:

Methode Electronics, Inc. Connector Products

1700 Hicks Road • Rolling Meadows, IL 60008 USA

847-392-3500 • Toll Free: 800-323-6864 • Fax: 847-392-9404

Email: info@methode.com • Web: www.methode.com/connector/index.html

Europe:

Methode Electronics Ireland, Ltd.

Unit H, Crossagalla Business Park, Ballysimon Rd. • Limerick, Ireland

+353 (0) 61 401222 • Fax: +353 (0) 61 401942

Email: info@methode.ie • Web: ireland.methode.com/main.html

Far East:

Methode Electronics Far East, Pte. Ltd.

1 Tuas Lane, Jurong Town • Singapore 638610

65-68615444 • Fax: 65-68614777

Email: sales@methode.com.sg • Web: www.methode.com/mefe/index.html