

LINEAR INTEGRATED CIRCUITS

## DUAL OPERATIONAL AMPLIFIERS

### DESCRIPTION

The SG2101A is a dual version of the SG101A Operational Amplifier and consists of two independent dice in the same package.

The SG2101A is a general-purpose internally compensated operational amplifier. It has excellent input bias current and drift characteristics in addition to short circuit protection and is pin compatible with industry standard operational amplifiers.

The SG2101A is guaranteed and fully characterized over the full military ambient temperature range of -55°C to 125°C.

### FEATURES

- Dual independent SG101A
- Offset voltage 3mV maximum over temperature
- Input bias current 100nA maximum over temperature
- Offset current 20nA maximum over temperature
- Guaranteed drift characteristics
- Offsets guaranteed over entire common-mode range

### HIGH RELIABILITY FEATURES - SG2101A

- ◆ Available to MIL-STD - 883
- ◆ MIL - M38510 / 10105BEA - JAN2101AJ
- ◆ SG level "S" processing available

### OPERATING CONDITIONS & ELECTRICAL SPECIFICATIONS

(All information is identical to the SG101A. Consult data sheet for specifics.)

### CONNECTION DIAGRAMS & ORDERING INFORMATION

Package	Part No.	Ambient Temperature Range	Connection Diagram
16-PIN CERAMIC DIP J - PACKAGE	SG2101AJ/883B SG2101AJ	-55°C to 125°C -55°C to 125°C	
16-PIN CERAMIC FLAT PACK F - PACKAGE	SG2101AF/883B SG2101AF	-55°C to 125°C -55°C to 125°C	

Note 1. Contact factory for JAN and DESC product availability.  
2. All parts are viewed from the top.

**OPERATIONAL AMPLIFIERS**

**DESCRIPTION**

The SG101A/201A/301A is a general purpose internally compensated operational amplifier. It has excellent input bias current and drift characteristics in addition to short circuit protection and is pin compatible with industry standard operational amplifiers.

The SG101A is guaranteed and fully characterized over the full military ambient temperature range of -55°C to 125°C while the SG201A is electrically identical, except its performance is guaranteed from -25°C to 85°C. The 301A is designed for commercial applications of 0°C to 70°C.

**FEATURES**

- Offset voltage 3mV maximum over temperature
- Input bias current 100nA maximum over temperature
- Offset current 20nA maximum over temperature
- Guaranteed drift characteristics
- Offsets guaranteed over entire common mode range

**HIGH RELIABILITY FEATURES - SG101A**

- ◆ Available to MIL-STD-883
- ◆ MIL-M38510/10103BGA - JAN101AT
- ◆ MIL - M38510 / 10103BHA - JAN101AF
- ◆ SG level "S" processing available

**SCHEMATIC DIAGRAM**

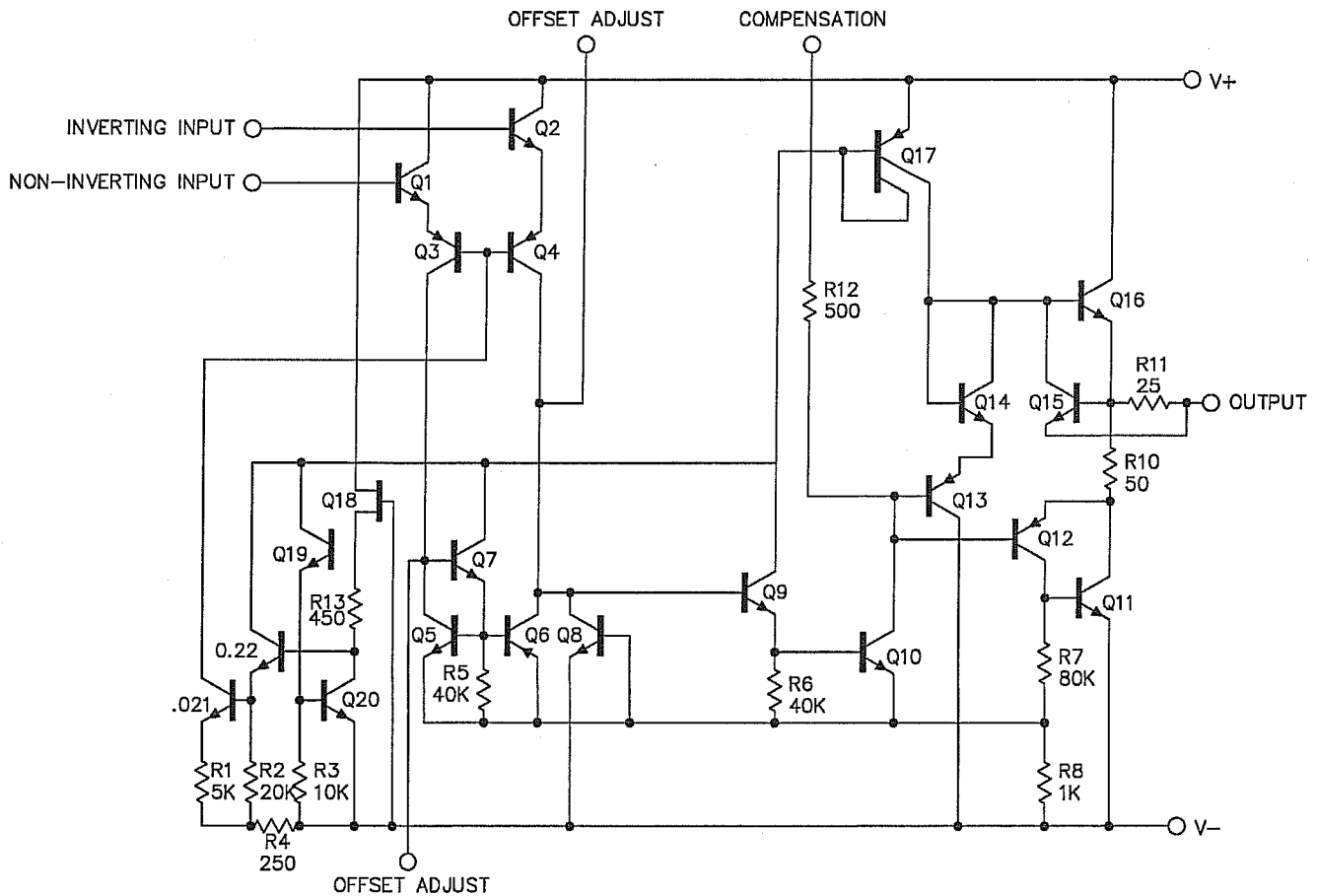

## ABSOLUTE MAXIMUM RATINGS (Note 1)

Supply Voltage	
SG101A/201A .....	±22V
SG301A .....	±18V
Differential Input Voltage .....	±30V
Input Voltage (Note 2) .....	±15V

Operating Junction Temperature	
Hermetic (T, J, F Packages) .....	150°C
Plastic (N Package) .....	150°C
Storage Temperature Range .....	-65°C to 150°C
Output Short Circuit Duration (Note 3) .....	Indefinite
Lead Temperature (Soldering, 10 Seconds) .....	300°C

Note 1. Exceeding these ratings could cause damage to the device.

Note 2. For supply voltages less than ±15V, the absolute maximum input voltage is equal to the supply voltage.

Note 3. Continuous short circuit is allowed for case temperatures to 125°C and ambient temperatures to 70°C.

## THERMAL DERATING CURVES

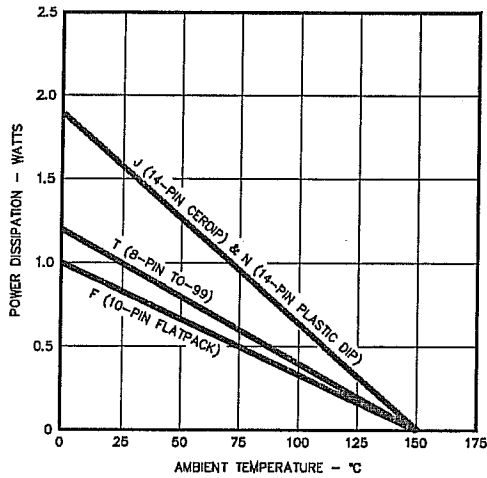

MAXIMUM POWER DISSIPATION vs AMBIENT TEMPERATURE

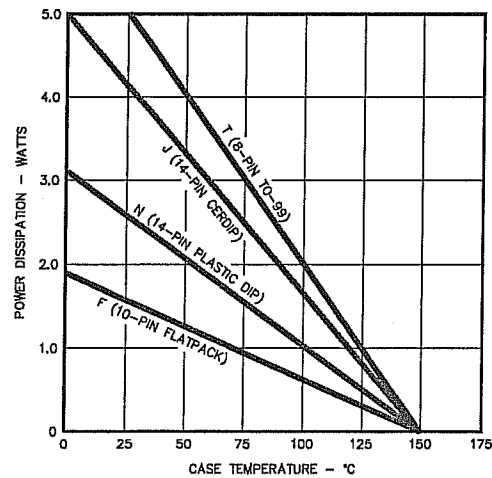

MAXIMUM POWER DISSIPATION vs CASE TEMPERATURE

## RECOMMENDED OPERATING CONDITIONS (Note 4 & 5)

Supply Voltage	
SG101A/201A .....	±5V to ±20V
SG301A .....	±5V to ±18V

Operating Ambient Temperature Range	
SG101A .....	-55°C to 125°C
SG201A .....	-25°C to 85°C
SG301A .....	0°C to 70°C

Note 4. Range over which the device is functional.

Note 5.  $R_L = 2K\Omega$ ,  $C_L = 100pF$ .

## ELECTRICAL SPECIFICATIONS

(Unless otherwise stated, these specifications apply for the operating ambient temperature of  $T_A = 25^\circ C$  and  $\pm 5V \leq V_S \leq \pm 20V$ , and  $C_L = 30pF$ . Low duty cycle pulse testing techniques are used which maintains junction and case temperatures equal to the ambient temperature.)

Parameter	Test Conditions	SG101A/SG201A			SG301A			Units
		Min.	Typ.	Max.	Min.	Typ.	Max.	
Input Offset Voltage	$R_S \leq 50K\Omega$		0.7	2.0		2.0	7.5	mV
Input Offset Current			1.5	10		3.0	50	nA
Input Bias Current	$T_A = T_{MIN}$ to $T_{MAX}$			20		70	70	nA
	$T_A = T_{MIN}$ to $T_{MAX}$		30	75		70	250	nA
Input Resistance (Note 5)				100			300	nA
		1.5	4		0.5	2		M $\Omega$
Supply Current	$V_S = \pm 20V$		1.8	3.0				mA
	$T_A = 125^\circ C$		1.2	2.5				mA
Large Signal Voltage Gain	$V_S = \pm 15V$				1.8	3.0		mA
	$V_S = \pm 15V, V_{OUT} = \pm 10V, R_L \geq 2K\Omega$	50	160		25	160		V/mV
Output Voltage Swing	$V_S = \pm 15V, V_{OUT} = \pm 10V, R_L \geq 2K\Omega$							V/mV
	$T_A = T_{MIN}$ to $T_{MAX}$	25			25			V
Input Voltage Range	$V_S = \pm 15V, R_L = 10K\Omega$	±12	±14		±12	±14		V
	$V_S = \pm 15V, R_L = 2K\Omega$	±10	±13		±10	±13		V
Common Mode Rejection Ratio	$V_S = \pm 20V, T_A = T_{MIN}$ to $T_{MAX}$	±15			±15			V
Supply Voltage Rejection Ratio	$R_S \leq 10K\Omega, T_A = T_{MIN}$ to $T_{MAX}$	80	96		80	96		dB
	$R_S \leq 10K\Omega, T_A = T_{MIN}$ to $T_{MAX}$	80	96		80	96		dB

ELECTRICAL SPECIFICATIONS (continued)

Parameter	Test Conditions	SG107/SG207			SG307			Units
		Min.	Typ.	Max.	Min.	Typ.	Max.	
Average Temperature Coefficient of Input Offset Voltage (Note 5)	$T_A = T_{MIN}$ to $T_{MAX}$		3.0	15		6.0	30	$\mu V/^{\circ}C$
Average Temperature Coefficient of Input Offset Current (Note 5)	$25^{\circ}C \leq T_A \leq 125^{\circ}C$		0.01	0.1				$nA/^{\circ}C$
	$-55^{\circ}C \leq T_A \leq 25^{\circ}C$		0.02	0.2				$nA/^{\circ}C$
	$25^{\circ}C \leq T_A \leq 70^{\circ}C$				0.01	0.3		$nA/^{\circ}C$
	$0^{\circ}C \leq T_A \leq 25^{\circ}C$				0.02	0.6		$nA/^{\circ}C$

Note 5. These parameters, although guaranteed, are not tested in production.

CHARACTERISTIC CURVES

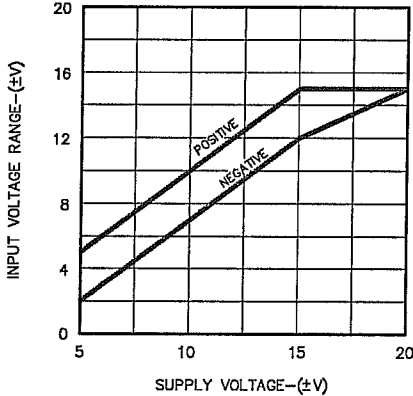

FIGURE 1. INPUT VOLTAGE RANGE VS. SUPPLY VOLTAGE

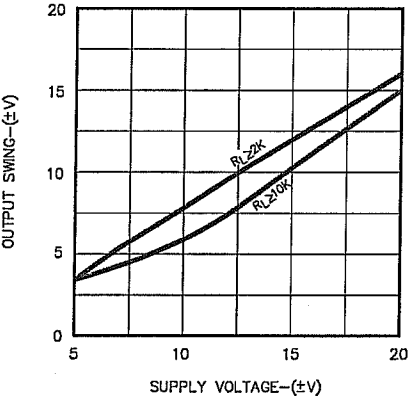

FIGURE 2. OUTPUT SWING VS. SUPPLY VOLTAGE

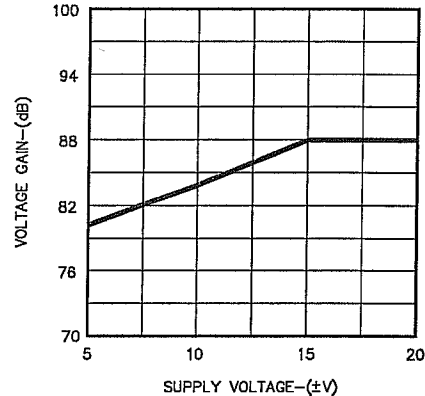

FIGURE 3. MINIMUM VOLTAGE GAIN

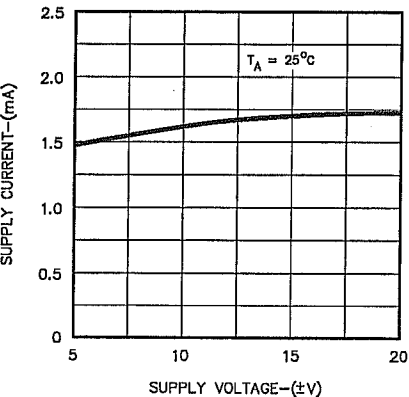

FIGURE 4. SUPPLY CURRENT VS. SUPPLY VOLTAGE

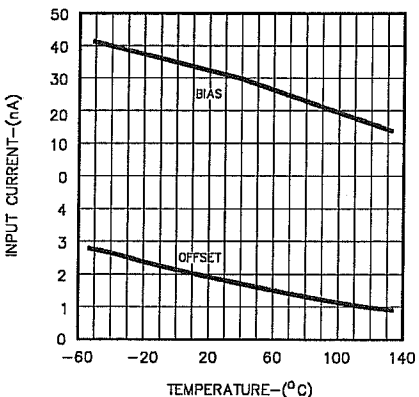

FIGURE 5. INPUT CURRENT VS. TEMPERATURE

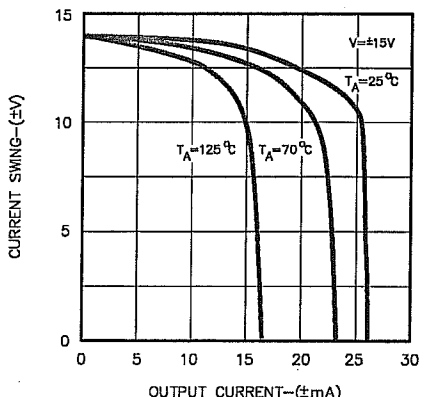

FIGURE 6. CURRENT LIMITING

**CHARACTERISTIC CURVES**

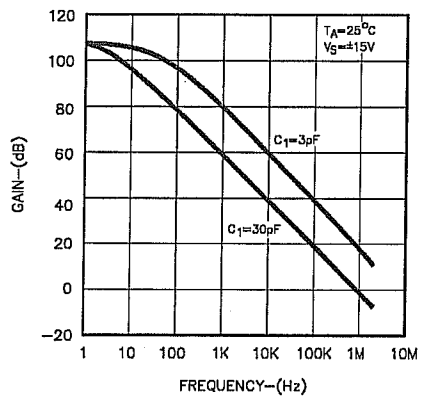

FIGURE 7. OPEN LOOP FREQUENCY RESPONSE

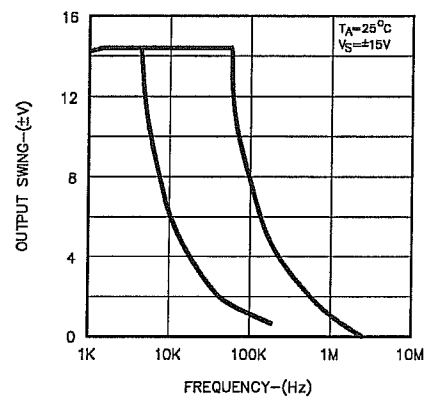

FIGURE 8. LARGE SIGNAL FREQUENCY RESPONSE

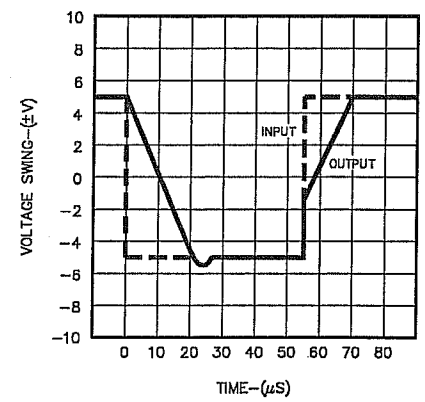

FIGURE 9. VOLTAGE FOLLOWER PULSE RESPONSE

**CONNECTION DIAGRAMS & ORDERING INFORMATION** (See Notes Below)

Package	Part No.	Ambient Temperature Range	Connection Diagram
14-PIN CERAMIC DIP J - PACKAGE	SG101AJ/883B SG101AJ SG201AJ SG301AJ	-55°C to 125°C -55°C to 125°C -25°C to 85°C 0°C to 70°C	
14-PIN PLASTIC DIP N - PACKAGE	SG201AN SG301AN	-25°C to 85°C 0°C to 70°C	
8-PIN METAL CAN T - PACKAGE	SG101AT/883B SG101AT SG201AT SG301AT	-55°C to 125°C -55°C to 125°C -25°C to 85°C 0°C to 70°C	
10-PIN CERAMIC FLAT PACK F - PACKAGE	SG101AF/883B SG101AF	-55°C to 125°C -55°C to 125°C	

Note 1. Contact factory for JAN and DESC product availability.  
 Note 2. All packages are viewed from the top.