

# CLC410

## Fast Settling, Video Op Amp with Disable

### General Description

The current-feedback CLC410 is a fast settling, wideband, monolithic op amp with fast disable/enable feature. Designed for low gain applications ( $A_V = \pm 1$  to  $\pm 8$ ), the CLC410 consumes only 160mW of power (180mW max) yet provides a -3dB bandwidth of 200MHz ( $A_V = +2$ ) and 0.05% settling in 12ns (15ns max). Plus, the disable feature provides fast turn on (100ns) and turn off (200ns). In addition, the CLC410 offers both high performance and stability without compensation - even at a gain of +1.

The CLC410 provides a simple, high performance solution for video switching and distribution applications, especially where analog buses benefit from use of the disable function to "multiplex" signals onto the bus. Differential gain/phase of 0.01%/0.01° provide high fidelity and the 60mA output current offers ample drive capability.

The CLC410's fast settling, low distortion, and high drive capabilities make it an ideal ADC driver. The low 160mW quiescent power consumption and very low 40mW disabled power consumption suggest use where power is critical and/or "system off" power consumption must be minimized.

The CLC410 is available in several versions to meet a variety of requirements. A three letter suffix determines the version.

### Enhanced Solutions (Military/Aerospace)

SMD Number: 5962-90600

Space level versions also available.

For more information, visit <http://www.national.com/mil>

### Features

- -3dB bandwidth of 200MHz
- 0.05% settling in 12ns
- Low Power, 160mW (40mW disabled)
- Low distortion, -60dBc at 20MHz
- Fast disable (200ns)
- Differential gain/phase: 0.01%/0.01°
- $\pm 1$  to  $\pm 8$  closed-loop gain range

### Applications

- Video switching and distribution
- Analog bus driving (with disable)
- Low power "standby" using Disable
- Fast, precision A/D conversion
- D/A current-to-voltage conversion
- IF processors
- High speed communications

### Enable/Disable Response

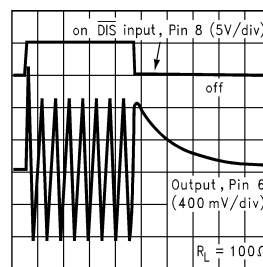

200 ns/div

01274910

### Non-Inverting Frequency Response

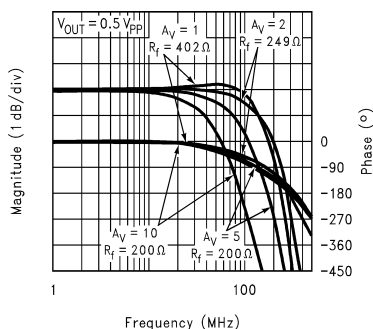

01274901

### Connection Diagram

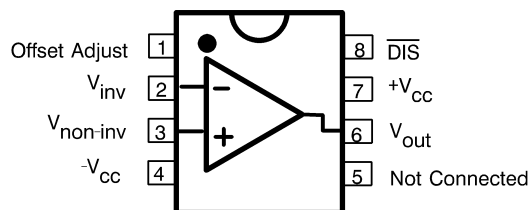

Pinout  
DIP & SOIC

01274921

**Absolute Maximum Ratings** (Note 1)

If Military/Aerospace specified devices are required, please contact the National Semiconductor Sales Office/Distributors for availability and specifications.

Supply Voltage ( $V_{CC}$ )  $\pm 7V$

$I_{OUT}$

Output is short circuit protected to ground, but maximum reliability will be maintained if  $I_{OUT}$  does not exceed...

60mA

Common Mode Input Voltage  $\pm V_{CC}$

$\pm V_{CC}$

Differential Input Voltage 5V

5V

Disable Input Voltage (pin 8)  $\pm V_{CC} - 1V$

$\pm V_{CC} - 1V$

Applied output voltage when disabled  $\pm V_{CC}$

$\pm V_{CC}$

Junction Temperature  $+150^{\circ}C$

Operating Temperature Range  $-40^{\circ}C$  to  $+85^{\circ}C$

Storage Temperature Range  $-65^{\circ}C$  to  $+150^{\circ}C$

Lead Solder Duration ( $+300^{\circ}C$ ) 10 sec

ESD Rating (human body model) 500V

**Operating Ratings**

Thermal Resistance

Package

( $\theta_{JC}$ )

( $\theta_{JA}$ )

MDIP

$65^{\circ}C/W$

$120^{\circ}C/W$

SOIC

$60^{\circ}C/W$

$140^{\circ}C/W$

**Electrical Characteristics**

$A_V = +2$ ,  $V_{CC} = \pm 5V$ ,  $R_L = 100\Omega$ ,  $R_f = 250\Omega$ ; unless specified

Symbol	Parameter	Conditions	Typ	Max/Min (Note 2)			Units
Ambient Temperature		CLC410AJ	$+25^{\circ}C$	$-40^{\circ}C$	$+25^{\circ}C$	$+85^{\circ}C$	
<b>Frequency Domain Response</b>							
SSBW	-3dB Bandwidth	$V_{OUT} < 0.5V_{PP}$	200	$>150$	$>150$	$>120$	MHz
LSBW		$V_{OUT} < 5V_{PP}$ , $A_V = +5$	50	$>35$	$>35$	$>35$	MHz
	Gain Flatness	$V_{OUT} < 0.5V_{PP}$					
GFPL	Peaking	DC to 40MHz	0	$<0.4$	$<0.3$	$<0.4$	dB
GFPH	Peaking	$>40MHz$	0	$<0.7$	$<0.5$	$<0.7$	dB
GFR	Rolloff	DC to 75MHz	0.6	$<1$	$<1$	$<1.3$	dB
LPD	Linear Phase Deviation	DC to 75MHz	0.2	$<1$	$<1$	$<1.2$	deg
<b>Time Domain Response</b>							
TRS	Rise and Fall Time	0.5V Step	1.6	$<2.4$	$<2.4$	$<2.4$	ns
TRL		5V Step	6.5	$<10$	$<10$	$<10$	ns
TSP	Settling Time to	$\pm 0.1\%$ 2V Step	10	$<13$	$<13$	$<13$	ns
TS		$\pm 0.05\%$ 2V Step	12	$<15$	$<15$	$<15$	ns
OS	Overshoot	0.5V Step	0	$<15$	$<10$	$<10$	%
SR	Slew Rate	$A_V = +2$	700	$>430$	$>430$	$>430$	V/ $\mu$ s
SR1		$A_V = -2$	1600	-	-	-	V/ $\mu$ s
<b>Distortion And Noise Response</b>							
HD2	2nd Harmonic Distortion	$2V_{PP}$ , 20MHz	-60	$<-40$	$<-45$	$<-45$	dBc
HD3	3rd harmonic distortion	$2V_{PP}$ , 20MHz	-60	$<-50$	$<-50$	$<-50$	dBc
	Equivalent Input Noise						
SNF	Noise Floor	$>1MHz$ (Note 4)	-157	$<-154$	$<-154$	$<-153$	dBm (1Hz)
INV	Integrated Noise	1MHz to 200MHz (Note 4)	40	$<54$	$<57$	$<63$	$\mu$ V
DG	Differential Gain (Note 5)	(See Plots)	0.01	0.05	0.04	0.04	%
DP	Differential Phase (Note 5)	(See Plots)	0.01	0.1	0.02	0.02	deg
<b>Disable/Enable Performance</b>							
TOFF	Disable Time to $>50dB$ Attenuation at 10MHz		200	$<1000$	$<1000$	$<1000$	ns
TON	Enable Time		100	$<200$	$<200$	$<200$	ns
	$\overline{DIS}$ Voltage						

**Electrical Characteristics** (Continued)
 $A_V = +2$ ,  $V_{CC} = \pm 5V$ ,  $R_L = 100\Omega$ ,  $R_f = 250\Omega$ ; unless specified

Symbol	Parameter	Conditions	Typ	Max/Min (Note 2)			Units
VDIS	To Disable		1.0	0.5	0.5	0.5	V
VEN	To Enable		2.6	2.3	3.2	4.0	V
	$\overline{\text{DIS}}$ current (sourced from CLC410, see Figure 5)						
IDIS	To Disable		200	250	250	250	$\mu\text{A}$
IEN	To Enable		80	60	60	60	$\mu\text{A}$
OSD	Off Isolation	At 10MHz	59	>55	>55	>55	dB
<b>Static, DC Performance</b>							
VIO	Input Offset Voltage (Note 3)		2	< $\pm 8.2$	< $\pm 5.0$	< $\pm 9.0$	mV
DVIO	average temperature coefficient		20	< $\pm 40$	–	< $\pm 40$	$\mu\text{V}/^\circ\text{C}$
IBN	Input Bias Current (Note 3)	Non Inverting	10	< $\pm 36$	< $\pm 20$	< $\pm 20$	$\mu\text{A}$
DIBN	Average Temperature Coefficient		100	< $\pm 200$	–	< $\pm 100$	$\text{nA}/^\circ\text{C}$
IBI	Input Bias Current (Note 3)	Inverting	10	< $\pm 36$	< $\pm 20$	< $\pm 30$	$\mu\text{A}$
DIBI	Average Temperature Coefficient		50	< $\pm 200$	–	< $\pm 100$	$\text{nA}/^\circ\text{C}$
PSRR	Power Supply Rejection Ratio		50	>45	>45	>45	dB
CMRR	Common Mode Rejection Ratio		50	>45	>45	>45	dB
ICC	Supply Current (Note 3)	No Load, Quiescent	16	<18	<18	<18	mA
ISD	Supply Current, Disabled	No Load, Quiescent	4	<6	<6	<6	mA
<b>Miscellaneous Performance</b>							
RIN	Non-Inverting Input	Resistance	200	>50	>100	>100	k $\Omega$
CIN		Capacitance	0.5	<2	<2	<2	pF
RO	Output Impedance	At DC	0.1	<0.2	<0.2	<0.2	$\Omega$
ROD	Output Impedance, Disabled	Resistance, at DC	200	<100	<100	<100	k $\Omega$
COD		Capacitance, at DC	0.5	<2	<2	<2	pF
VO	Output Voltage Range	No Load	$\pm 3.5$	> $\pm 3$	> $\pm 3.2$	> $\pm 3.2$	V
CMIR	Common Mode Input Range	For Rated Performance	$\pm 2.1$	> $\pm 1.2$	> $\pm 2$	> $\pm 2$	V
IO	Output Current	–40°C to +85°C	$\pm 70$	> $\pm 35$	> $\pm 50$	> $\pm 50$	mA
IO		–55°C to +125°C	$\pm 60$	> $\pm 30$	> $\pm 50$	> $\pm 50$	mA

**Note 1:** “Absolute Maximum Ratings” are those values beyond which the safety of the device cannot be guaranteed. They are not meant to imply that the devices should be operated at these limits. The table of “Electrical Characteristics” specifies conditions of device operation.

**Note 2:** Min/max ratings are based on product characterization and simulation. Individual parameters are tested as noted. Outgoing quality levels are determined from tested parameters.

**Note 3:** AJ-level: spec. is 100% tested at +25°C, sample at 85°C.

**Note 4:** Noise tests are performed from 5MHz to 200MHz.

**Note 5:** Differential gain and phase measured at:  $A_V = +2$ ,  $R_f = 250\Omega$ ,  $R_L = 150\Omega$  1V<sub>pp</sub> equivalent video signal, 0-100 IRE, 40 IRE<sub>pp</sub>, 3.58 MHz, IRE = 0 volts, at 75 $\Omega$  load. See text.

**Ordering Information**

Package	Temperature Range Industrial	Part Number	Package Marking	NSC Drawing
8-pin plastic DIP	–40°C to +85°C	CLC410AJP	CLC410AJP	N08A
8-pin plastic SOIC	–40°C to +85°C	CLC410AJE	CLC410AJE	M08A

**Typical Performance Characteristics** ( $T_A = 25^\circ$ ,  $A_V = +2$ ,  $V_{CC} = \pm 5V$ ,  $R_L = 100\Omega$ ; Unless Specified).

**Non-Inverting Frequency Response**

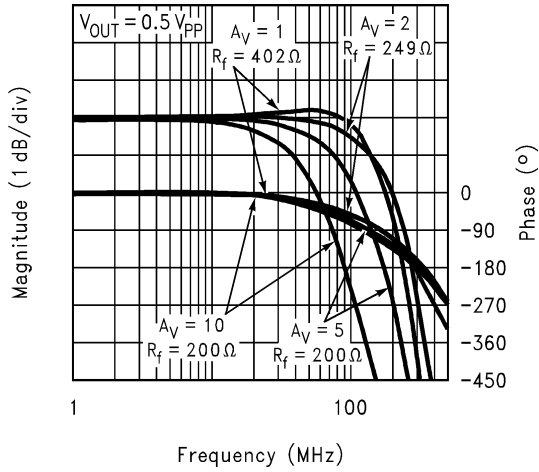

01274901

**Inverting Frequency Response**

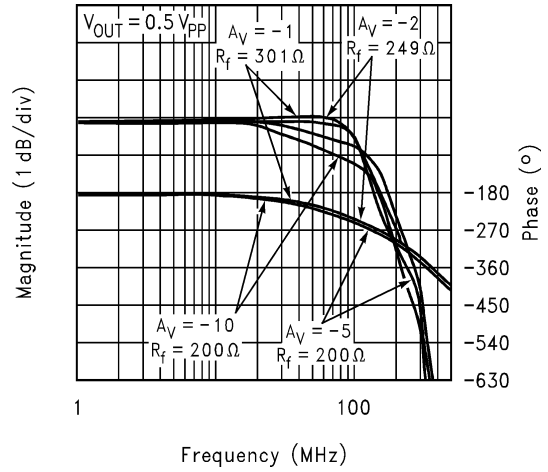

01274902

**Frequency Response for Various  $R_L$ S**

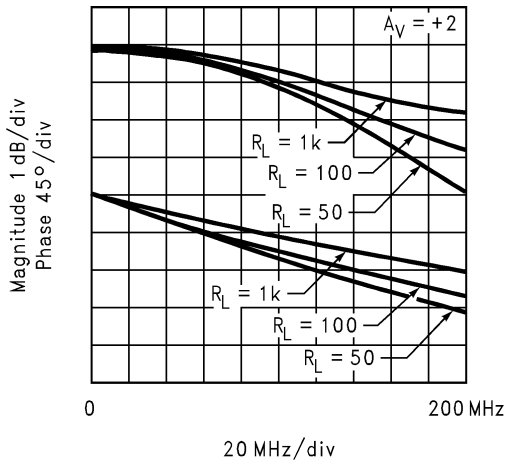

01274903

**Forward and Reverse Gain During Disable**

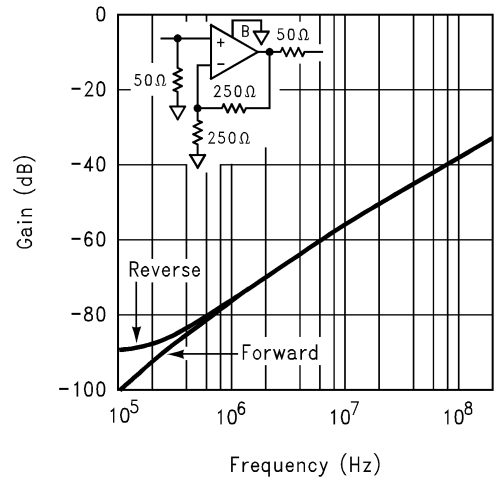

01274904

**2nd and 3rd Harmonic Distortion**

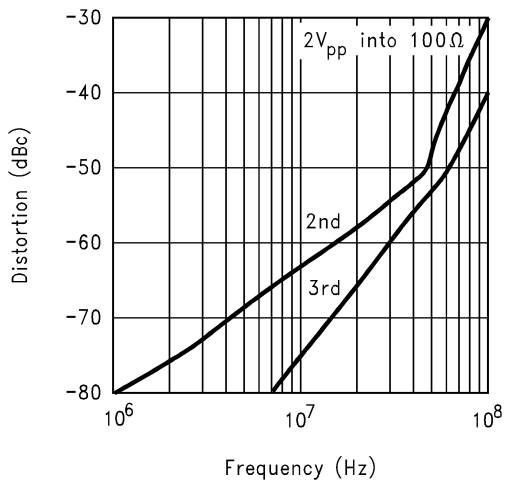

01274905

**2-Tone, 3rd Order, Intermodulation Intercept**

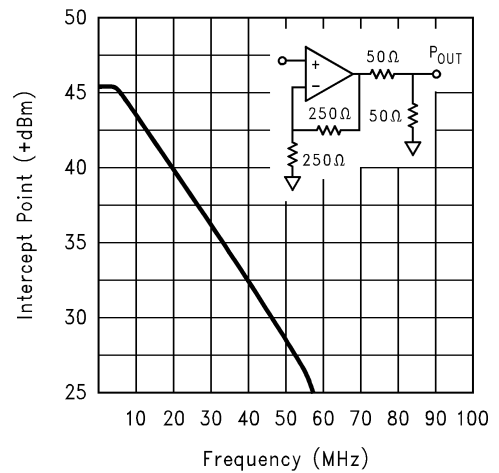

01274906

**Typical Performance Characteristics** ( $T_A = 25^\circ$ ,  $A_V = +2$ ,  $V_{CC} = \pm 5V$ ,  $R_L = 100\Omega$ ; Unless Specified). (Continued)

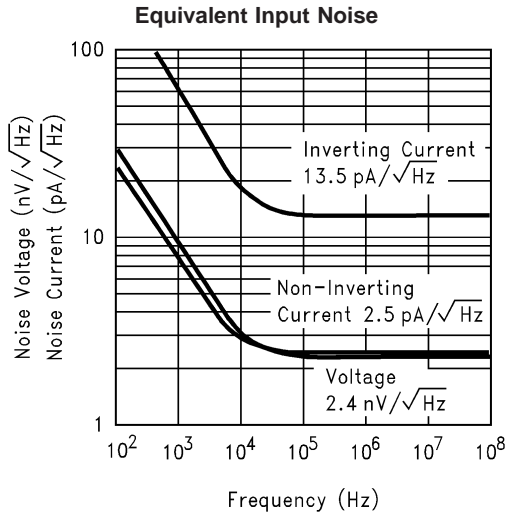

01274907

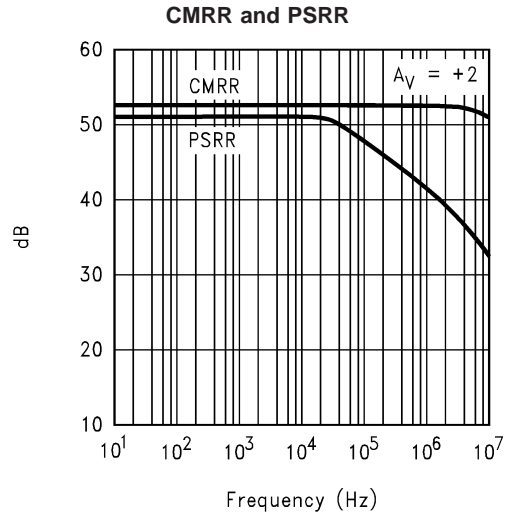

01274908

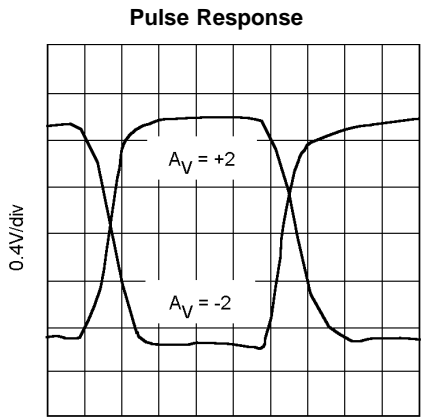

01274928

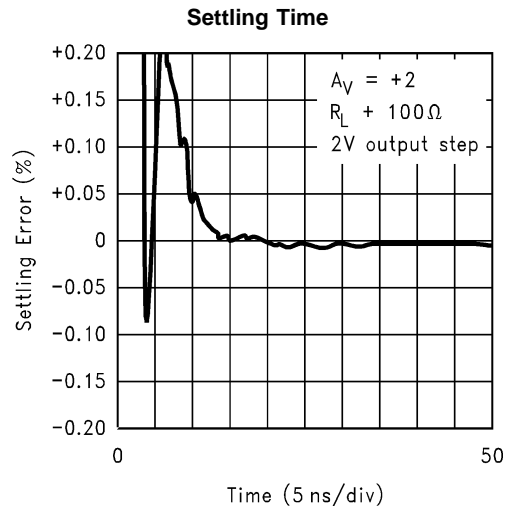

01274923

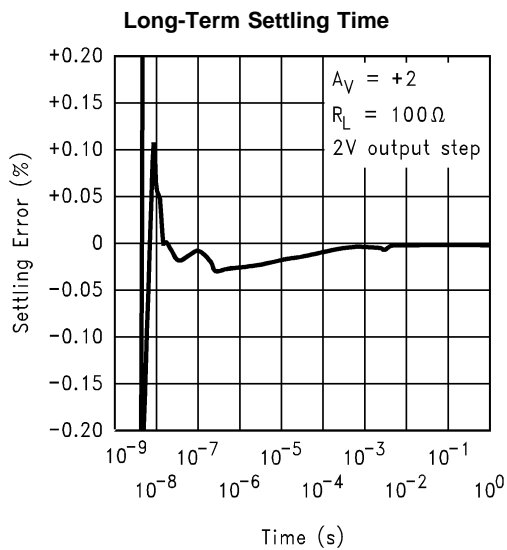

01274924

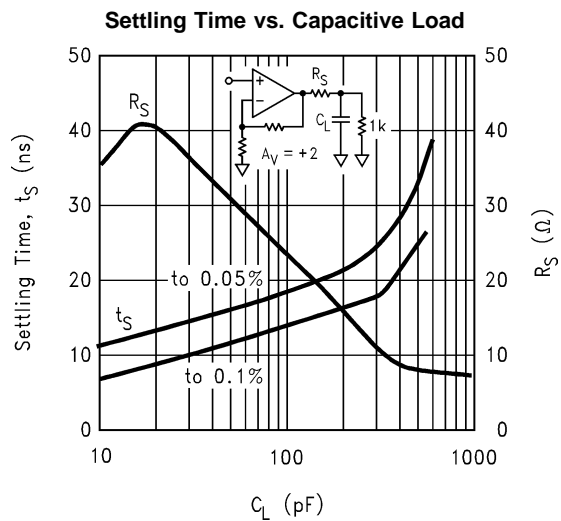

01274909

**Typical Performance Characteristics** ( $T_A = 25^\circ$ ,  $A_V = +2$ ,  $V_{CC} = \pm 5V$ ,  $R_L = 100\Omega$ ; Unless Specified). (Continued)

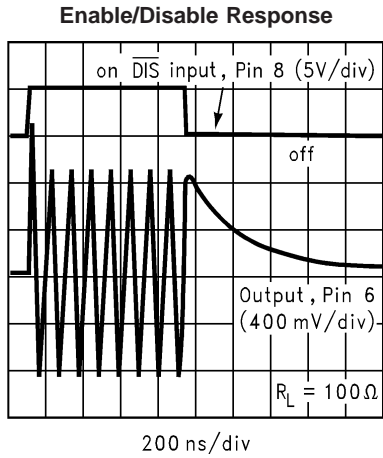

01274910

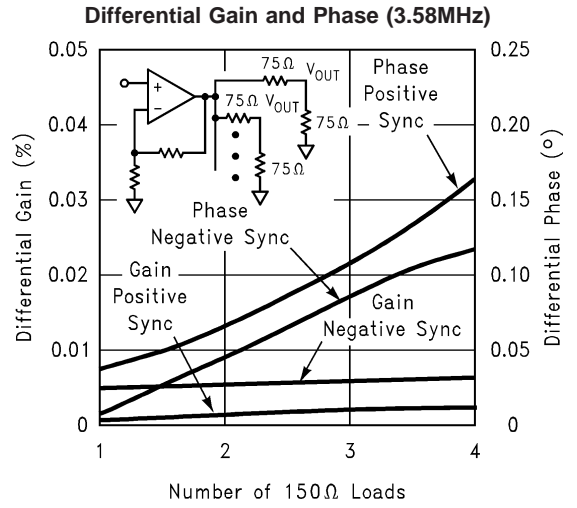

01274911

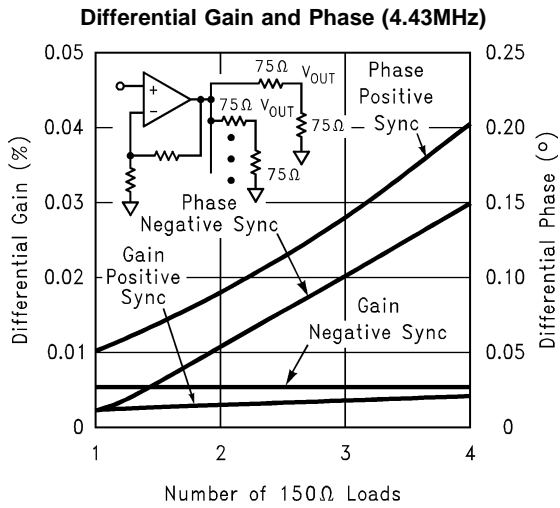

01274912

## Application Division

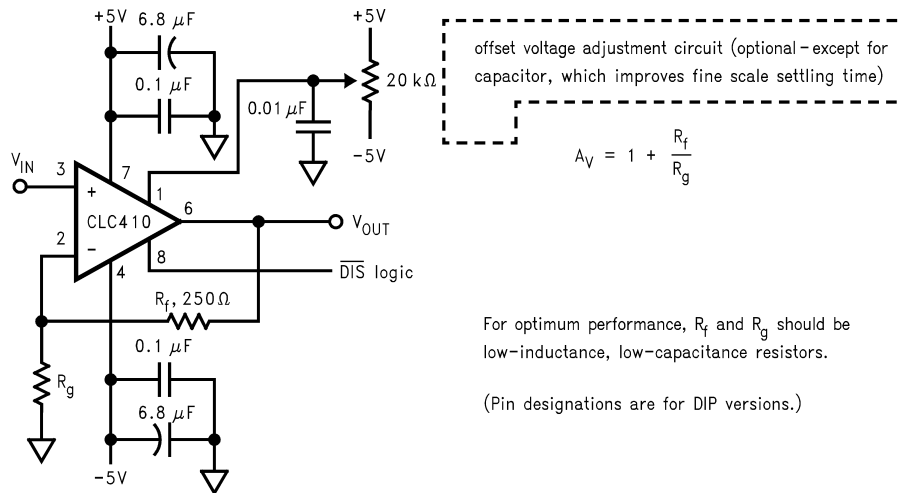

01274913

FIGURE 1. Recommended Non-Inverting Gain Circuit

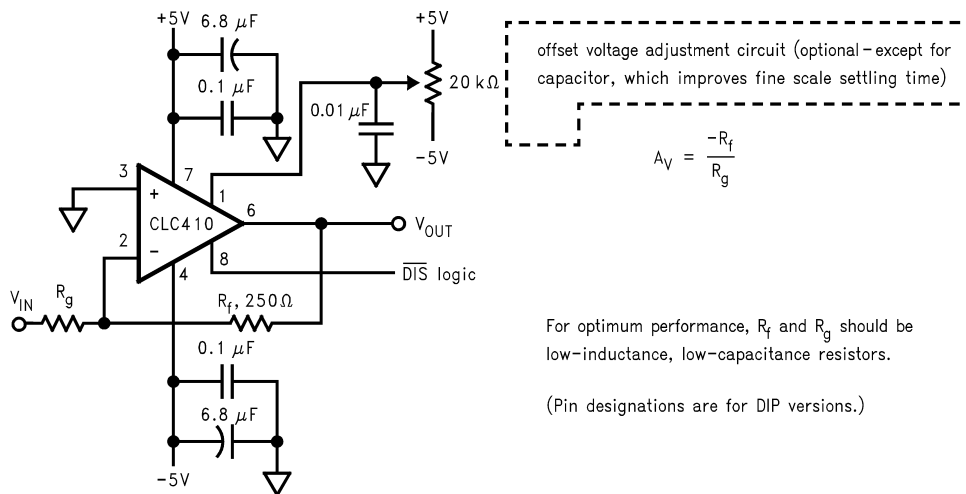

01274914

FIGURE 2. Recommended Inverting Gain Circuit

## Application Division (Continued)

### Enable/Disable Operation

The CLC410 has an enable/disable feature that is useful for conserving power and for multiplexing the outputs of several amplifiers onto an analog bus (Figure 3). Disabling an amplifier while not in use reduces power supply current and the output and inverting input pins become a high impedance.

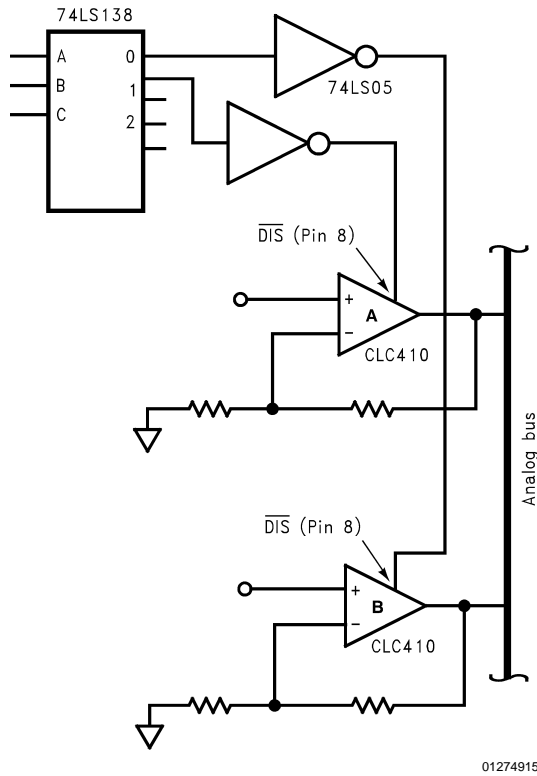

FIGURE 3.

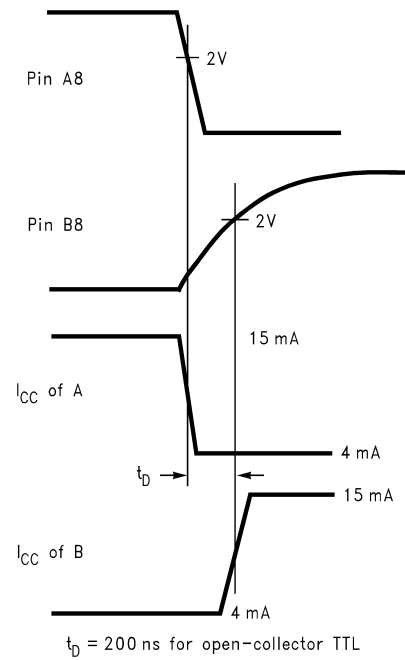
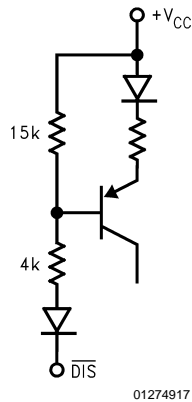

FIGURE 4.

Pin 8, the  $\overline{\text{DIS}}$  pin, can be driven from either open-collector TTL or from 5V CMOS. A logic low disables the amplifier and an internal  $15\text{k}\Omega$  pull-up resistor ensures that the amplifier is enabled if pin 8 is not connected (Figure 5). Both TTL and 5V CMOS logic are guaranteed to drive a high enough high-level output voltage ( $V_{\text{OH}}$ ) to ensure that the CLC410 is enabled. Whichever type used, "break-before-make" operation should be established when outputs of several amplifiers are connected together. This is important for avoiding large, transient currents flowing between amplifiers when two or more are simultaneously enabled. Typically, proper operation is ensured if all the amplifiers are driven from the same decoder integrated circuit because logic output rise times tend to be longer than fall times. As a result, the amplifier being disabled will reach the 2V threshold sooner than the amplifier being enabled (see  $t_{\text{D}}$  of Figure 4 timing diagram).



## Application Division (Continued)



01274917

**FIGURE 5. Equivalent of  $\overline{\text{DIS}}$  input**

During disable, supply current drops to approximately 4mA and the inverting input and output pin impedances become  $200\text{k}\Omega \parallel 0.5\text{pF}$  each. The total impedance that a disabled amplifier and its associated feedback network presents to the analog bus is determined from *Figure 6*. For example, at a non-inverting gain of 1, the output impedance at video frequencies is  $100\text{k}\Omega \parallel 1\text{pF}$  since the  $250\Omega$  feedback resistor is a negligible impedance. Similarly, output impedance is  $500\Omega \parallel 0.5\text{pF}$  at a non-inverting gain of 2 (with  $R_f = R_g = 250\Omega$ ).

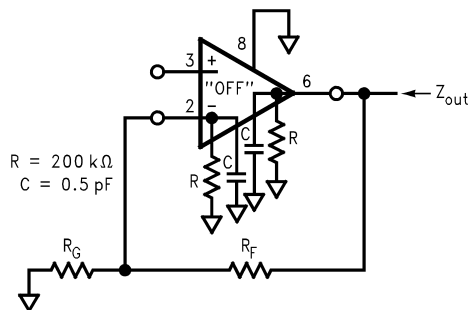

01274918

**FIGURE 6.**

### Differential Gain and Phase

Plots on the preceding page illustrate the differential gain and phase performance of the CLC410 at both 3.58MHz and 4.43MHz. Application Note OA-08 presents a measurement technique for measuring the very low differential gain and phase of the CLC410. Observe that the gain and phase errors remain low even as the output loading increases, making the device attractive for driving multiple video outputs.

### Understanding the Loop Gain

The CLC410 is a current-feedback op amp. Referring to the equivalent circuit of *Figure 7*, any current flowing in the inverting input is amplified to a voltage at the output through the transimpedance gain shown below. This  $Z(s)$  is analogous to the open-loop gain of a voltage feedback amplifier.

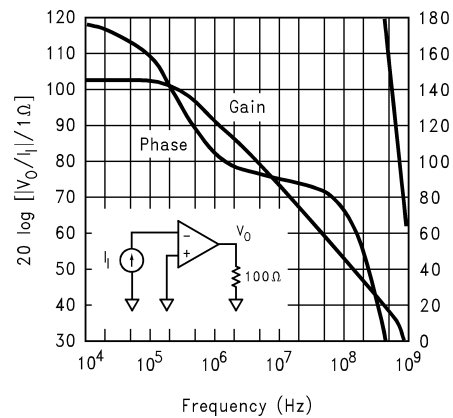

01274919

**Open-Loop Transimpedance Gain,  $Z(s)$**

Developing the non-inverting frequency response for the topology of *Figure 3* yields:

$$\frac{V_O}{V_i} = \frac{1 + R_f / R_g}{1 - 1 / LG} \quad (1)$$

where LG is the loop gain defined by,

$$LG = \frac{Z(s)}{R_f} \times \frac{1}{1 + Z_i / (R_f \parallel R_g)} \quad (2)$$

Equation 1 has a form identical to that for a voltage feedback amplifier with the differences occurring in the LG expression, eq.2. For an idealized treatment, set  $Z_i = 0$  which results in a very simple  $LG = Z(s)/R_f$  (Derivation of the transfer function for the case where  $Z_i = 0$  is given in Application Note AN300-1). Using the  $Z(s)$  (open-loop transimpedance gain) plot shown on the previous page and dividing by the recommended  $R_f = 250\Omega$ , yields a large loop gain at DC. As a result, Equation 1 shows that the closed-loop gain at DC is very close to  $(1 + R_f/R_g)$ .

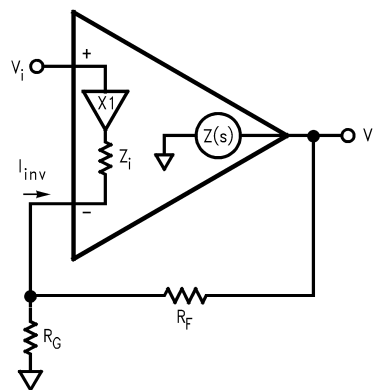

01274920

**FIGURE 7. Current Feedback Topology**

At higher frequencies, the roll-off of  $Z(s)$  determines the closed-loop frequency response which, ideally, is dependent only on  $R_f$ . **The specifications reported on the previous pages are therefore valid only for the specified  $R_f = 250\Omega$ .** Increasing  $R_f$  from  $250\Omega$  will decrease the loop gain

## Application Division (Continued)

and band width, while decreasing it will increase the loop gain possibly leading to inadequate phase margin and closed-loop peaking. Conversely, fixing  $R_f$  will hold the frequency response constant while the closed-loop gain can be adjusted using  $R_g$ .

The CLC410 departs from this idealized analysis to the extent that the inverting input impedance is finite. With the low quiescent power of the CLC410,  $Z_i \approx 50\Omega$  leading to drop in loop gain and bandwidth at high gain settings, as given by equation 2. The second term in Equation 2 accounts for the division in feedback current that occurs between  $Z_i$  and  $R_f \parallel R_g$  at the inverting node of the CLC410. This decrease in bandwidth can be circumvented as described in "Increasing Bandwidth at High Gains." Also see "Current Feedback Amplifiers" in the National Databook for a thorough discussion of current feedback op amps.

### Increasing Bandwidth At High Gains

Bandwidth may be increased at high closed-loop gains by adjusting  $R_f$  and  $R_g$  to make up for the losses in loop gain that occur at these high gain settings due to current division at the inverting input. An approximate relationship may be obtained by holding the LG expression constant as the gain is changed from the design point used in the specifications (that is,  $R_f = 250\Omega$  and  $R_g = 250\Omega$ ). For the CLC400 this gives,

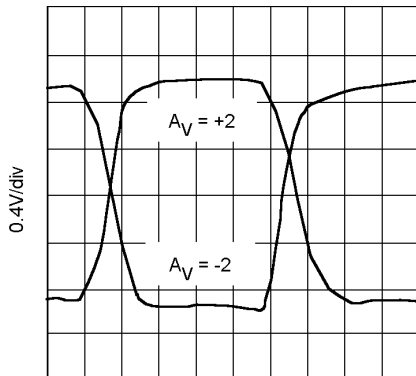

(3)

where  $A_v$  is the non-inverting gain. Note that with  $A_v = +2$  we get the specified  $R_f = 250\Omega$ , while at higher gains, a lower value gives stable performance with improved bandwidth.

### DC Accuracy and Noise

Since the two inputs for the CLC410 are quite dissimilar, the noise and offset error performance differs somewhat from that of a standard differential input amplifier. Specifically, the inverting input current noise is much larger than the non-inverting current noise. Also the two input bias currents are physically unrelated rendering bias current cancellation through matching of the inverting and non-inverting pin resistors ineffective.

In Equation 4, the output offset is the algebraic sum of the equivalent input voltage and current sources that influence DC operation. Output noise is determined similarly except that a root-sum-of-squares replaces the algebraic sum.  $R_s$  is the non-inverting pin resistance.

### Equation 4

$$\text{Output Offset } V_O = \pm IB_N \times R_s (1 + R_f/R_g) \pm$$

$$VIO (1 + R_f/R_g) \pm IB_I \times R_f$$

An important observation is that for fixed  $R_f$ , offsets as referred to the input improve as the gain is increased (divide all terms by  $1 + R_f/R_g$ ). A similar result is obtained for noise where noise figure improves as a gain increases.

The input noise plot shown in the CLC400 datasheet applies equally as well to the CLC410.

### Capacitive Feedback

Capacitive feedback should not be used with the CLC410 because of the potential for loop instability. See Application Note OA-7 for active filter realizations with the CLC410.

### Offset Adjustment Pin

Pin 1 can be connected to a potentiometer as shown in *Figure 1* and used to adjust the input offset of the CLC410. Full range adjustment of  $\pm 5V$  on pin 1 will yield a  $\pm 10mV$  input offset adjustment range. Pin 1 should always be bypassed to ground with a ceramic capacitor located close to the package for best settling performance.

### Printed Circuit Layout

As with any high frequency device, a good PCB layout will enhance performance. Ground plane construction and good power supply bypassing close to the package are critical to achieving full performance. In the non-inverting configuration, the amplifier is sensitive to stray capacitance to ground at the inverting input. Hence, the inverting node connections should be small with minimal coupling to the ground plane. Shunt capacitance across the feedback resistor should not be used to compensate for this effect.

Parasitic or load capacitance directly on the output will introduce additional phase shift in the loop degrading the loop phase margin and leading to frequency response peaking. A small series resistor before the capacitance effectively decouples this effect. The graphs on the preceding page illustrates the required resistor value and resulting performance vs. capacitance.

Precision buffed resistors (PRP8351 series from Precision Resistive Products) with low parasitic reactances were used to develop the data sheet specifications. Precision carbon composition resistors will also yield excellent results. Standard spirally-trimmed RN55D metal film resistors will work with a slight decrease in bandwidth due to their reactive nature at high frequencies.

Evaluation PC boards (part no. 730013 for through-hole and 730027 for SOIC) for the CLC404 are available.

**Physical Dimensions** inches (millimeters)

unless otherwise noted

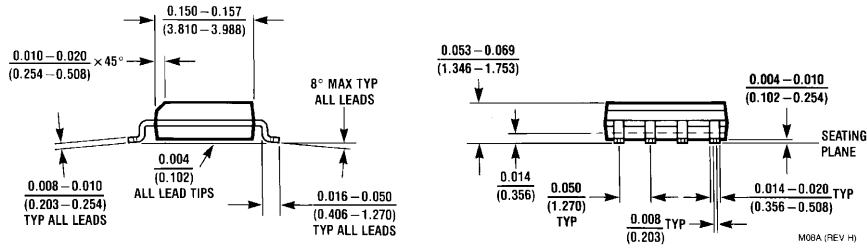
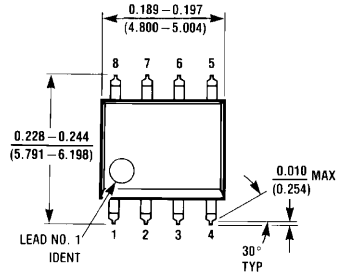

**8-Pin SOIC**  
NS Package Number M08A

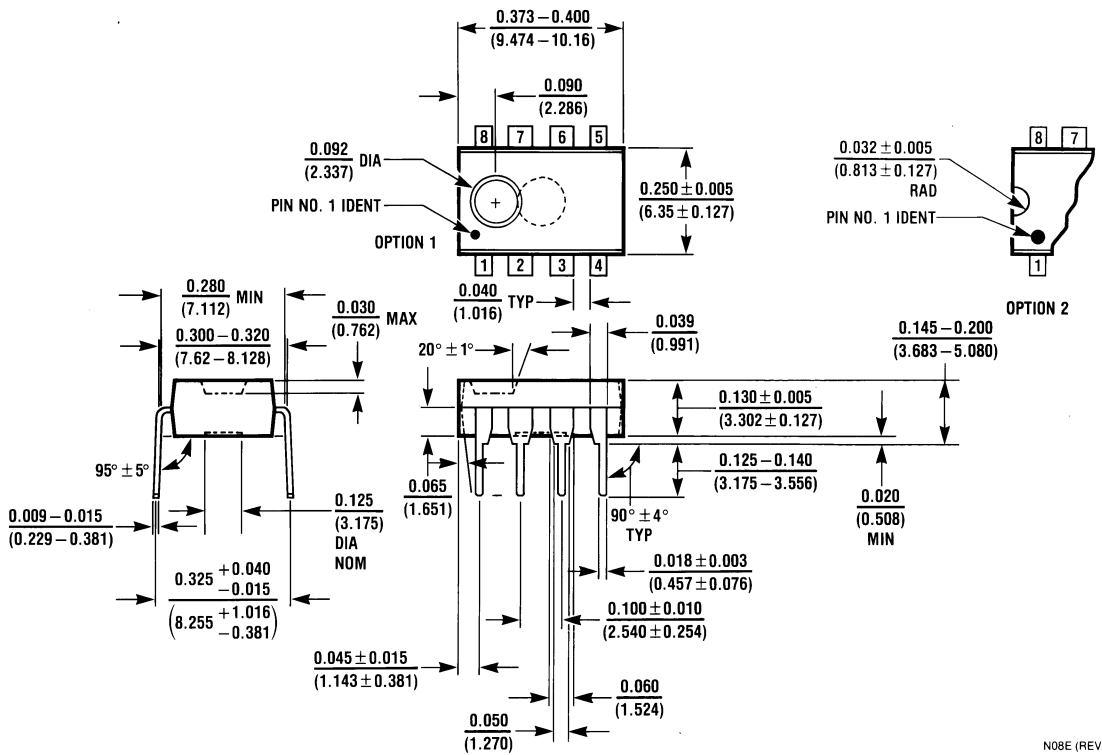

**8-Pin MDIP**  
NS Package Number N08E

## Notes

### LIFE SUPPORT POLICY

NATIONAL'S PRODUCTS ARE NOT AUTHORIZED FOR USE AS CRITICAL COMPONENTS IN LIFE SUPPORT DEVICES OR SYSTEMS WITHOUT THE EXPRESS WRITTEN APPROVAL OF THE PRESIDENT AND GENERAL COUNSEL OF NATIONAL SEMICONDUCTOR CORPORATION. As used herein:

1. Life support devices or systems are devices or systems which, (a) are intended for surgical implant into the body, or (b) support or sustain life, and whose failure to perform when properly used in accordance with instructions for use provided in the labeling, can be reasonably expected to result in a significant injury to the user.
2. A critical component is any component of a life support device or system whose failure to perform can be reasonably expected to cause the failure of the life support device or system, or to affect its safety or effectiveness.



**National Semiconductor Corporation**  
Americas  
Email: support@nsc.com

[www.national.com](http://www.national.com)

**National Semiconductor Europe**

Fax: +49 (0) 180-530 85 86  
Email: europe.support@nsc.com  
Deutsch Tel: +49 (0) 69 9508 6208  
English Tel: +44 (0) 870 24 0 2171  
Français Tel: +33 (0) 1 41 91 8790

**National Semiconductor Asia Pacific Customer Response Group**

Tel: 65-2544466  
Fax: 65-2504466  
Email: ap.support@nsc.com

**National Semiconductor Japan Ltd.**

Tel: 81-3-5639-7560  
Fax: 81-3-5639-7507