

RoHS compliant

REV	DESCRIPTION	DATE

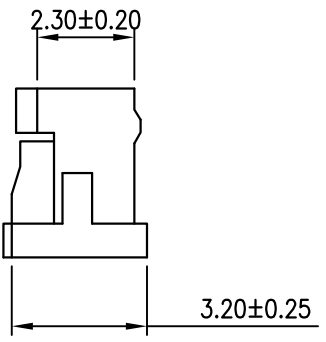

NOTES

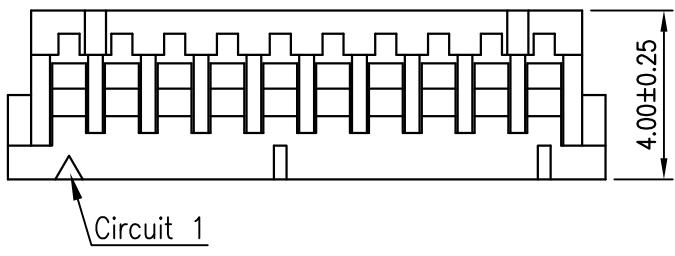
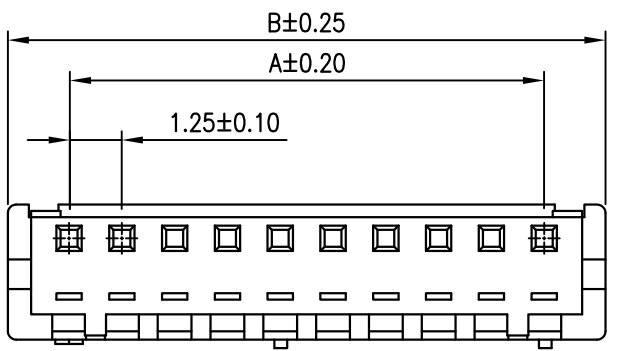

Available in 02 through 15 Circuits
 Material: Nylon 66 UL94V-0
 Accepts YY-0900-T Crimp Terminal
 Mates with YY-0900-WXXS or YY-0900-WXXR Series Wafer

ORDERING INFORMATION

YY-0900 - $\frac{H}{1} \frac{XX}{2}$

- 1. H : Housing
- 2. No. of Circuits 02~15

Circuits	Dimension mm		Circuits	Dimension mm	
	A	B		A	B
2	1.25	4.15	9	10.00	12.90
3	2.50	5.40	10	11.25	14.15
4	3.75	6.65	11	12.50	15.40
5	5.00	7.90	12	13.75	16.65
6	6.25	9.15	14	16.25	19.15
7	7.50	10.40	15	17.50	20.40
8	8.75	11.65	--	--	--

TOLERANCE		 Young Yak Enterprise Co., Ltd.			
X.	--				
X.X	--	TITLE 1.25mm(.049") Pitch Wire to Board Housing			
X.XX	--				
X.XXX	--				
ANGULAR	--				
APPROVALS					
DRAWN	Frank		SCALE	PART NO.	REV.
25-SEPTEMBER-2008			6:1	YY-0900-HXX	A0
CHECKED	Denise	UNIT	SIZE	DWG NO.	SHEET
25-SEPTEMBER-2008		MM	A4	YY-0900-HXX-152	1 OF 1
APPROVED	Jessica				
25-SEPTEMBER-2008					



RoHS compliant

REV	DESCRIPTION	DATE

NOTES

Available in 10 through 40 Circuits
 Material: Nylon66 UL94V-0
 Accepts YY-0900-T Crimp Terminal
 Mates with YY-0900D-SXXS Series Wafer

ORDERING INFORMATION

YY-0900D - H XX
 1 2

- 1. H : Housing
- 2. No. of Circuits 10~40

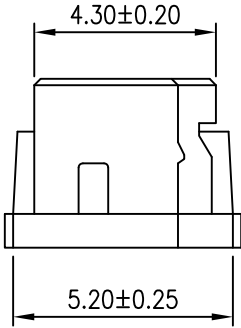
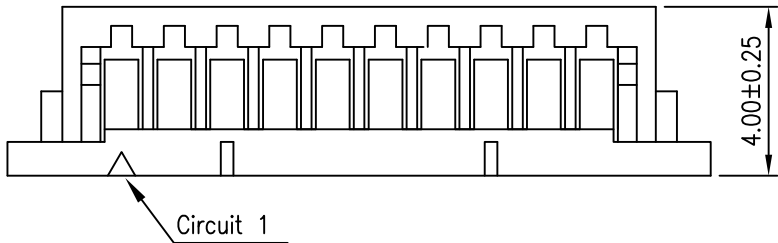
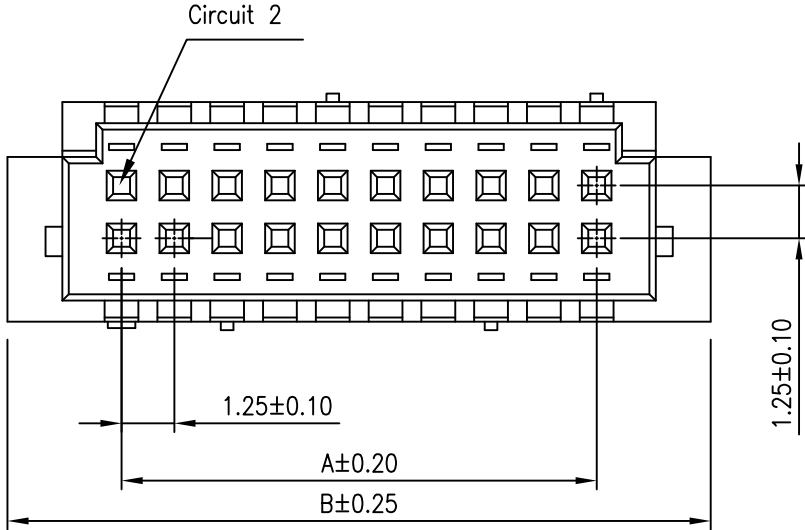

Circuits	Dimension mm	
	A	B
10	5.00	10.40
20	11.25	16.65
30	17.50	22.90
40	23.75	29.15

TOLERANCE	
X.	--
X.X	--
X.XX	--
X.XXX	--
ANGULAR	--
APPROVALS	
DRAWN	Frank 24-SEPTEMBER-2008
CHECKED	Denise 24-SEPTEMBER-2008
APPROVED	Jessica 24-SEPTEMBER-2008

 **Young Yak Enterprise Co., Ltd.**

TITLE: 1.25mm(.049") Pitch
 Wire to Board Housing

VIEW	SCALE	PART NO.	REV.
	6:1	YY-0900D-HXX	A0
UNIT	SIZE	DWG NO.	SHEET
MM	A4	YY-0900D-HXX-152	1 OF 1



REV	DESCRIPTION	DATE

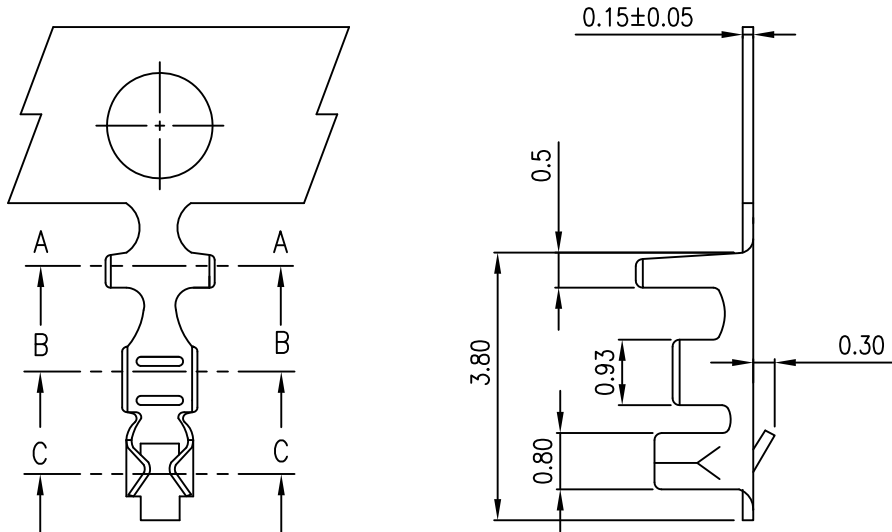

NOTES



Used in YY-0900-H & YY-0900D-H Series Housing
 Accepts AWG 28~32 Wire Range
 Insulation O.D.= 1.2 mm(max)
 Material : Phosphor Bronze
 Finish : Tin-Plated
 Qty/Reel : 15,000 PCS
 Thickness: 0.15mm

ORDERING INFORMATION

YY- 0900 - T TA P
 1 2 3

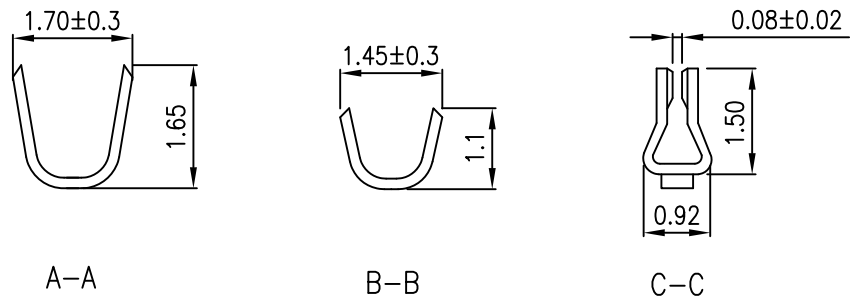
1. T : Terminal
2. TA : Tin , Pre-tinned
3. Material
 P : Phosphor Bronze



TOLERANCE		 Young Yak Enterprise Co., Ltd.			
X.	--	TITLE 1.25mm(.049") Pitch Wire to Board Terminal			
X.X	±0.25				
X.XX	±0.13				
X.XXX	±0.08				
ANGULAR	--				
APPROVALS					
DRAWN	Frank	VIEW	SCALE	PART NO.	REV.
	26-SEPTEMBER-2008		10:1	YY-0900-TTAP	A0
CHECKED	Denise	UNIT	SIZE	DWG NO.	SHEET
	26-SEPTEMBER-2008	MM	A4	YY-0900-TTAP-012	1 OF 1
APPROVED	Jessica				
	26-SEPTEMBER-2008				



RoHS compliant

REV	DESCRIPTION	DATE

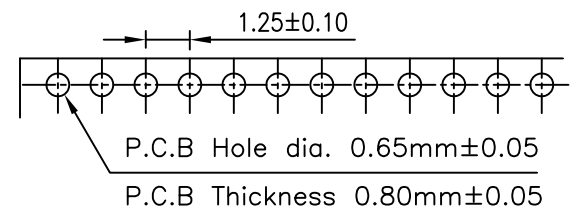
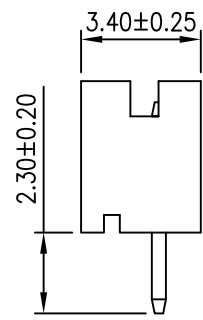
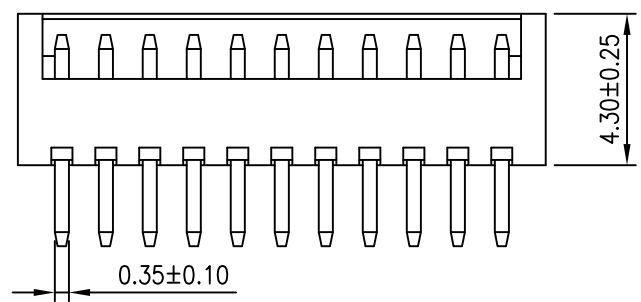
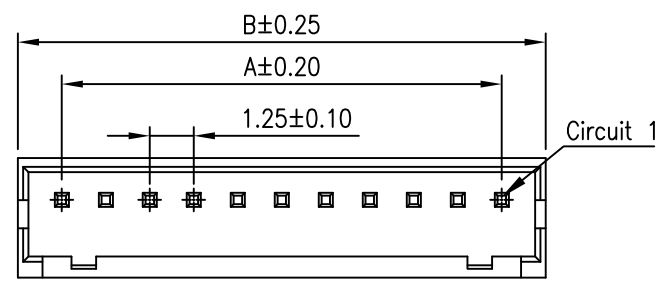

PCB LAYOUT

NOTES



Available in 2 through 15 Circuits
 Material: Nylon 66 UL94-V0
 Accepts YY-0900-H Series Housing
 0.35mm(.014") Square Pin
 Pin Material: Brass/Tin-Plated

ORDERING INFORMATION

YY-0900 - W XX S T
 1 2 3 4

1. W : Wafer
 2. No. of Circuits 02~15
 3. S : Straight
 4. Plated
- T : Tin

Circuits	Dimension mm		Circuits	Dimension mm	
	A	B		A	B
2	1.25	3.75	9	10.00	12.50
3	2.50	5.00	10	11.25	13.75
4	3.75	6.25	11	12.50	15.00
5	5.00	7.50	12	13.75	16.25
6	6.25	8.75	13	15.00	17.50
7	7.50	10.00	14	16.25	18.75
8	8.75	11.25	15	17.50	20.00

TOLERANCE		 Young Yak Enterprise Co., Ltd. TITLE 1.25mm(.049") Pitch Wire to Board Wafer			
X.	--				
X.X	--				
X.XX	--				
X.XXX	--				
ANGULAR	--				
APPROVALS					
DRAWN	Frank	VIEW	SCALE	PART NO.	REV.
	26-SEPTEMBER-2008		5:1	YY-0900-WXXST	A0
CHECKED	Denise	UNIT	SIZE	DWG NO.	SHEET
	26-SEPTEMBER-2008	MM	A4	YY-0900-WXXST-152	1 OF 1
APPROVED	Jessica				
	26-SEPTEMBER-2008				



RoHS compliant

REV	DESCRIPTION	DATE

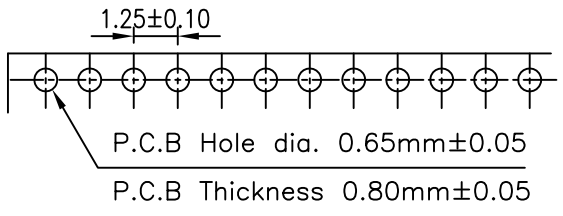
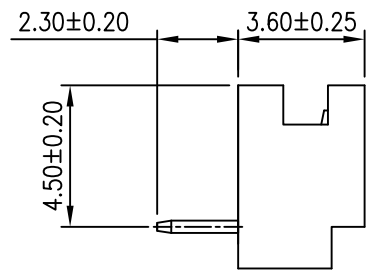
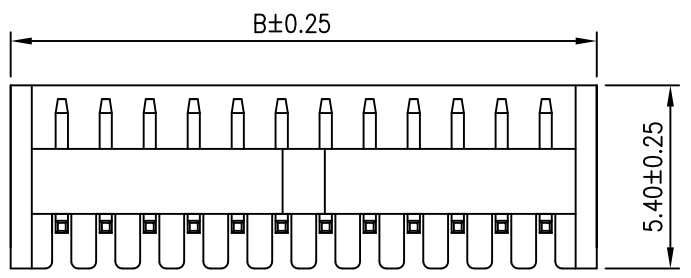
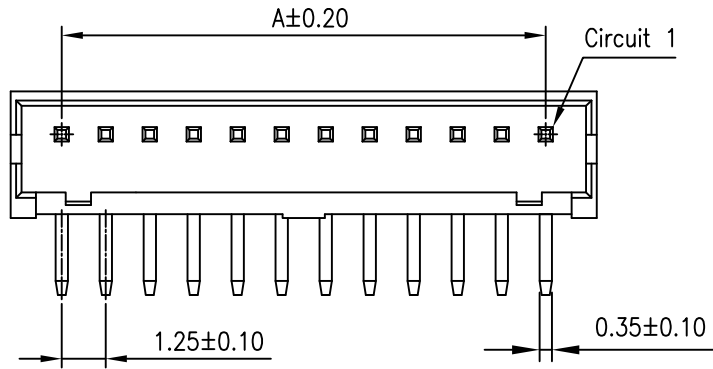

PCB LAYOUT

NOTES

Available in 2 through 15 Circuits
 Material: Nylon 66 UL94-V0
 Accepts YY-0900-H Series Housing
 0.35mm(.014") Square Pin
 Pin Material: Brass/Tin-Plated



ORDERING INFORMATION

YY-0900 - W XX R T

1 2 3 4

- 1. W : Wafer
- 2. No. of Circuits 02~15
- 3. R : Right Angle
- 4. Plated
- T : Tin

Circuits	Dimension mm		Circuits	Dimension mm	
	A	B		A	B
2	1.25	3.75	9	10.00	12.50
3	2.50	5.00	10	11.25	13.75
4	3.75	6.25	11	12.50	15.00
5	5.00	7.50	12	13.75	16.25
6	6.25	8.75	13	15.00	17.50
7	7.50	10.00	14	16.25	18.75
8	8.75	11.25	15	17.50	20.00

TOLERANCE		 Young Yak Enterprise Co., Ltd.			
X.	--	TITLE 1.25mm(.049") Pitch Wire to Board Wafer			
X.X	--				
X.XX	--				
X.XXX	--				
ANGULAR	--				
APPROVALS					
DRAWN	Frank	VIEW	SCALE	PART NO.	REV.
	26-SEPTEMBER-2008		5:1	YY-0900-WXXRT	A0
CHECKED	Denise	UNIT	SIZE	DWG NO.	SHEET
	26-SEPTEMBER-2008	MM	A4	YY-0900-WXXRT-152	1 OF 1
APPROVED	Jessica				
	26-SEPTEMBER-2008				



RoHS compliant

REV	DESCRIPTION	DATE

NOTES

Available in 2 through 15 Circuits
 Material: Nylon 6T UL94-V0
 Accepts YY-0900-H Series Housing
 0.35mm(.014") Square Pin
 Pin Material: Phosphor Bronze/Gold-Plated

ORDERING INFORMATION

YY-0900 - S XX S G X
 1 2 3 4 5

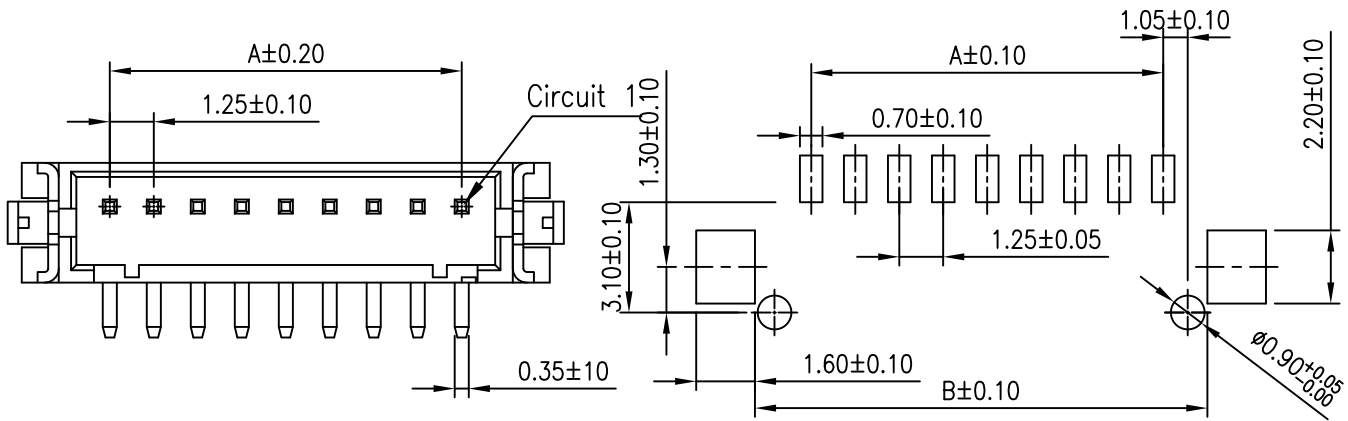

1. S : SMT
2. No. of Circuits 02~15
3. S : Straight
4. Plated
G : Gold
5. Packing
A : Tape & Reel
B : Tube Package
C : Box Package

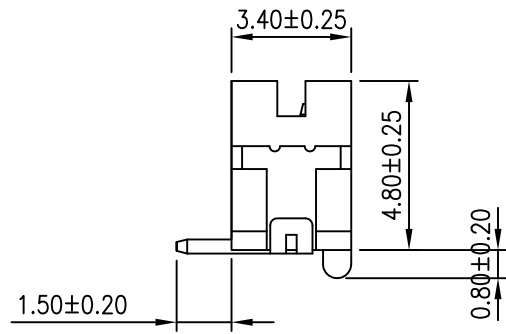
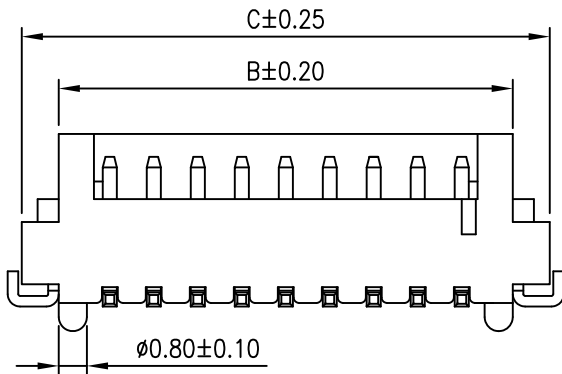

PCB LAYOUT



Circuits	Dimension mm			Circuits	Dimension mm		
	A	B	C		A	B	C
2	1.25	4.15	6.25	9	10.00	12.90	15.00
3	2.50	5.40	7.50	10	11.25	14.15	16.25
4	3.75	6.65	8.75	11	12.50	15.40	17.50
5	5.00	7.90	10.00	12	13.75	16.65	18.75
6	6.25	9.15	11.25	13	15.00	17.90	20.00
7	7.50	10.40	12.50	14	16.25	19.15	21.25
8	8.75	11.65	13.75	15	17.50	20.40	22.50

TOLERANCE		 Young Yak Enterprise Co., Ltd.		
X.	--			
X.X	--			
X.XX	--			
X.XXX	--			
ANGULAR	--			
APPROVALS		TITLE		
DRAWN	Frank	1.25mm(.049") Pitch		REV.
	26-SEPTEMBER-2008	Wire to Board Wafer		
CHECKED	Denise	VIEW	SCALE	PART NO.
	26-SEPTEMBER-2008		F	YY-0900-SXXSGX
APPROVED	Jessica	UNIT	SIZE	DWG NO.
	26-SEPTEMBER-2008	MM	A4	YY-0900-SXXSGX-152
				SHEET
				1 OF 1



RoHS compliant

REV	DESCRIPTION	DATE

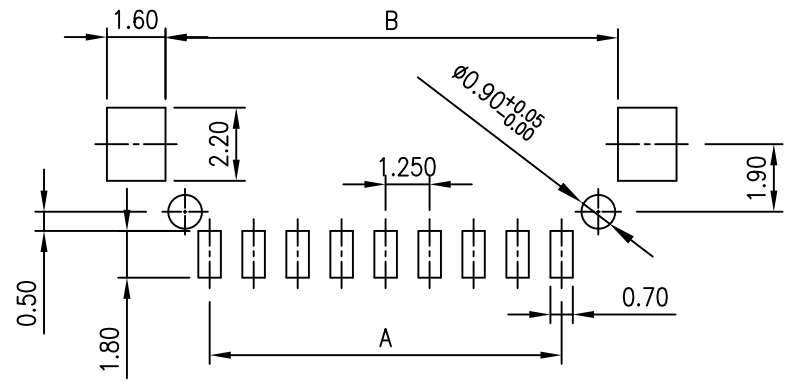
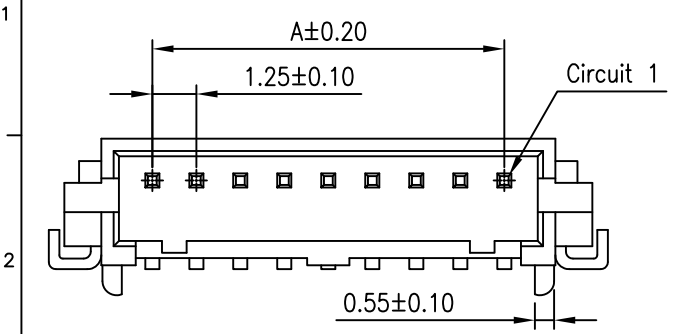

PCB LAYOUT

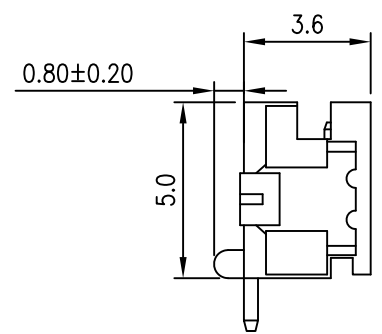
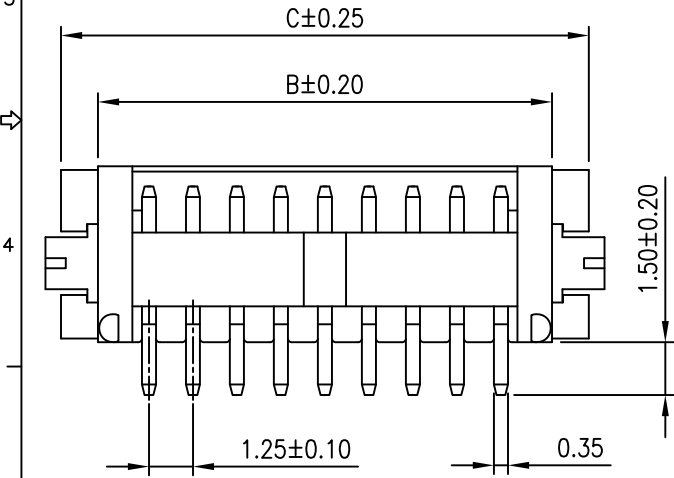

NOTES



Available in 2 through 15 Circuits
 Material: Nylon 6T UL94-V0
 Accepts YY-0900-H Series Housing
 0.35mm(.014") Square Pin
 Pin Material: Phosphor Bronze/Gold-Plated

ORDERING INFORMATION

YY-0900 - S XX R G X
1 2 3 4 5

1. S : SMT
2. No. of Circuits 02~15
3. R : Right Angle
4. Plated
 G : Gold
5. Packing
 A : Tape & Reel
 B : Tube Package
 C : Box Package

Circuits	Dimension mm			Circuits	Dimension mm		
	A	B	C		A	B	C
2	1.25	4.15	6.25	9	10.00	12.90	15.00
3	2.50	5.40	7.50	10	11.25	14.15	16.25
4	3.75	6.65	8.75	11	12.50	15.40	17.50
5	5.00	7.90	10.00	12	13.75	16.65	18.75
6	6.25	9.15	11.25	13	15.00	17.90	20.00
7	7.50	10.40	12.50	14	16.25	19.15	21.25
8	8.75	11.65	13.75	15	17.50	20.40	22.50

TOLERANCE		 Young Yak Enterprise Co., Ltd. TITLE 1.25mm(.049") Pitch Wire to Board Wafer			
X.	--				
X.X	--				
X.XX	--				
X.XXX	--				
ANGULAR					
APPROVALS					
DRAWN	Frank	VIEW	SCALE	PART NO.	REV.
	26-SEPTEMBER-2008		F	YY-0900-SXXRGX	A0
CHECKED	Denise	UNIT	SIZE	DWG NO.	SHEET
	26-SEPTEMBER-2008	MM	A4	YY-0900-SXXRGX-152	1 OF 1
APPROVED	Jessica				
	26-SEPTEMBER-2008				



RoHS compliant

REV	DESCRIPTION	DATE

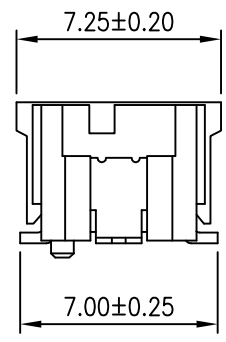
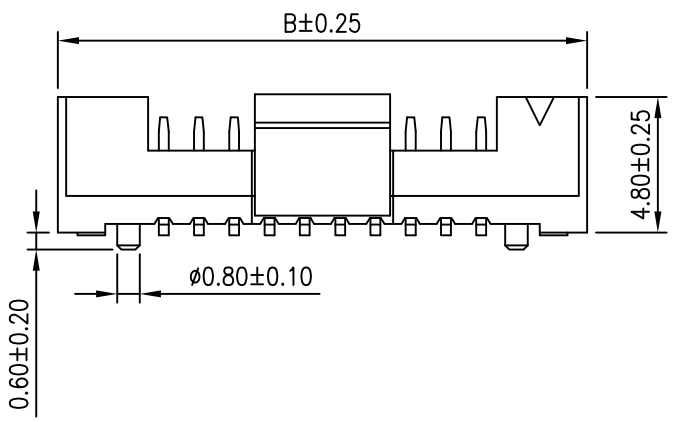
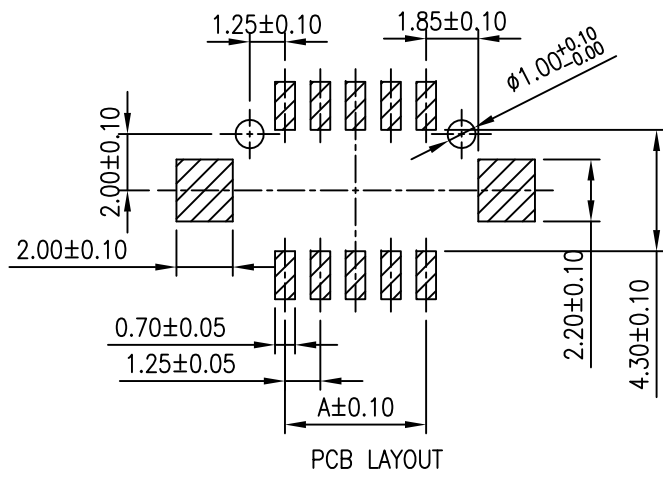
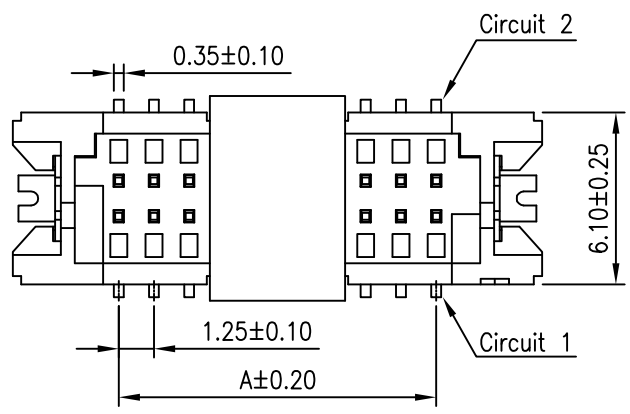

NOTES



Available in 10 through 40 Circuits
 Material: Nylon 6T UL94-V0
 Accepts YY-0900D-H Series Housing
 0.35mm(.014") Flat Pin
 PIN Material: Brass/Gold-Plated
 Solder Tabs: Brass/Tin-Plated

ORDERING INFORMATION

YY-0900D - S XX S G X
1 2 3 4 5

- 1. S : SMT
- 2. No. of Circuits 10~40
- 3. S : Straight
- 4. Plated
 G : Gold
- 5. Packing
 A : Tape & Reel
 B : Tube Package

Circuits	Dimension mm	
	A	B
10	5.00	12.50
20	11.25	18.75
30	17.50	25.00
40	23.75	31.25

TOLERANCE		 Young Yak Enterprise Co., Ltd.		
X.	--			
X.X	--			
X.XX	--			
X.XXX	--			
ANGULAR	--			
APPROVALS		TITLE		
DRAWN	Frank	1.25mm(.049") Pitch		REV.
	25-SEPTEMBER-2008	Wire to Board Wafer		
CHECKED	Denise	VIEW	SCALE	PART NO.
	25-SEPTEMBER-2008		4:1	YY-0900D-SXXSGX
APPROVED	Jessica	UNIT	SIZE	DWG NO.
	25-SEPTEMBER-2008	MM	A4	YY-0900D-SXXSGX-152
				SHEET
				1 OF 1

