

TLE202x-EP, TLE202xA-EP EXCALIBUR HIGH-SPEED LOW-POWER PRECISION OPERATIONAL AMPLIFIERS

SGLS235B– FEBRUARY 2004 – REVISED JUNE 2007

- **Controlled Baseline**
 - One Assembly/Test Site, One Fabrication Site
- **Extended Temperature Performance of –40°C to 125°C**
- **Enhanced Diminishing Manufacturing Sources (DMS) Support**
- **Enhanced Product-Change Notification**
- **Qualification Pedigree†**
- **Supply Current . . . 300 μ A Max**
- **High Unity-Gain Bandwidth . . . 2 MHz Typ**
- **High Slew Rate . . . 0.45 V/ μ s Min**
- **Supply-Current Change Over Full Temp Range . . . 10 μ A Typ at $V_{CC\pm} = \pm 15$ V**
- **Specified for Both 5-V Single-Supply and ± 15 -V Operation**
- **Phase-Reversal Protection**
- **High Open-Loop Gain . . . 6.5 V/ μ V (136 dB) Typ**
- **Low Offset Voltage . . . 100 μ V Max**
- **Offset Voltage Drift With Time 0.005 μ V/mo Typ**
- **Low Input Bias Current . . . 50 nA Max**
- **Low Noise Voltage . . . 19 nV/ $\sqrt{\text{Hz}}$ Typ**

† Component qualification in accordance with JEDEC and industry standards to ensure reliable operation over an extended temperature range. This includes, but is not limited to, Highly Accelerated Stress Test (HAST) or biased 85/85, temperature cycle, autoclave or unbiased HAST, electromigration, bond intermetallic life, and mold compound life. Such qualification testing should not be viewed as justifying use of this component beyond specified performance and environmental limits.

description

The TLE202x and TLE202xA devices are precision, high-speed, low-power operational amplifiers using a new Texas Instruments Excalibur process. These devices combine the best features of the OP21 with highly improved slew rate and unity-gain bandwidth.

The complementary bipolar Excalibur process utilizes isolated vertical pnp transistors that yield dramatic improvement in unity-gain bandwidth and slew rate over similar devices.

The addition of a bias circuit in conjunction with this process results in extremely stable parameters with both time and temperature. This means that a precision device remains a precision device even with changes in temperature and over years of use.

This combination of excellent dc performance with a common-mode input voltage range that includes the negative rail makes these devices the ideal choice for low-level signal conditioning applications in either single-supply or split-supply configurations. In addition, these devices offer phase-reversal protection circuitry that eliminates an unexpected change in output states when one of the inputs goes below the negative supply rail.

A variety of options are available in small-outline packaging for high-density systems applications.

The Q-suffix devices are characterized for operation over the full automotive temperature range of –40°C to 125°C.



Please be aware that an important notice concerning availability, standard warranty, and use in critical applications of Texas Instruments semiconductor products and disclaimers thereto appears at the end of this data sheet.

PRODUCTION DATA information is current as of publication date. Products conform to specifications per the terms of Texas Instruments standard warranty. Production processing does not necessarily include testing of all parameters.

 **TEXAS
INSTRUMENTS**

POST OFFICE BOX 655303 • DALLAS, TEXAS 75265

Copyright © 2007 Texas Instruments Incorporated

TLE202x-EP, TLE202xA-EP EXCALIBUR HIGH-SPEED LOW-POWER PRECISION OPERATIONAL AMPLIFIERS

SGLS235B– FEBRUARY 2004 – REVISED JUNE 2007

ORDERING INFORMATION

T _A	V _{IO} max AT 25°C	PACKAGE†		ORDERABLE PART NUMBER	TOP-SIDE MARKING
–40°C to 125°C	200 μV	SOIC (D)	Tape and reel	TLE2021AQDREP	2021AE
	500 μV	SOIC (D)	Tape and reel	TLE2021QDREP	2021QE
	300 μV	SOIC (D)	Tape and reel	TLE2022AQDREP	2022AE
	500 μV	SOIC (D)	Tape and reel	TLE2022QDREP	2022QE
	750 μV	SOP (DW)	Tape and reel	TLE2024AQDWREP	2024AE
	1000 μV	SOP (DW)	Tape and reel	TLE2024QDWREP	2024QE

† Package drawings, standard packing quantities, thermal data, symbolization, and PCB design guidelines are available at www.ti.com/sc/package.

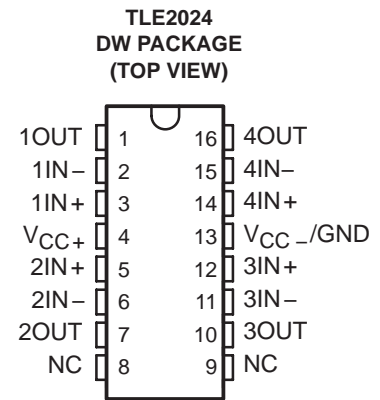
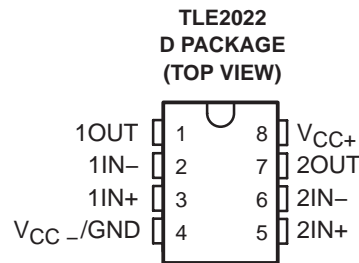
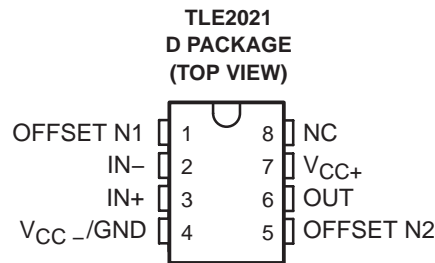

NC – No internal connection

TLE202x-EP, TLE202xA-EP EXCALIBUR HIGH-SPEED LOW-POWER PRECISION OPERATIONAL AMPLIFIERS

SGLS235B – FEBRUARY 2004 – REVISED JUNE 2007

equivalent schematic (each amplifier)

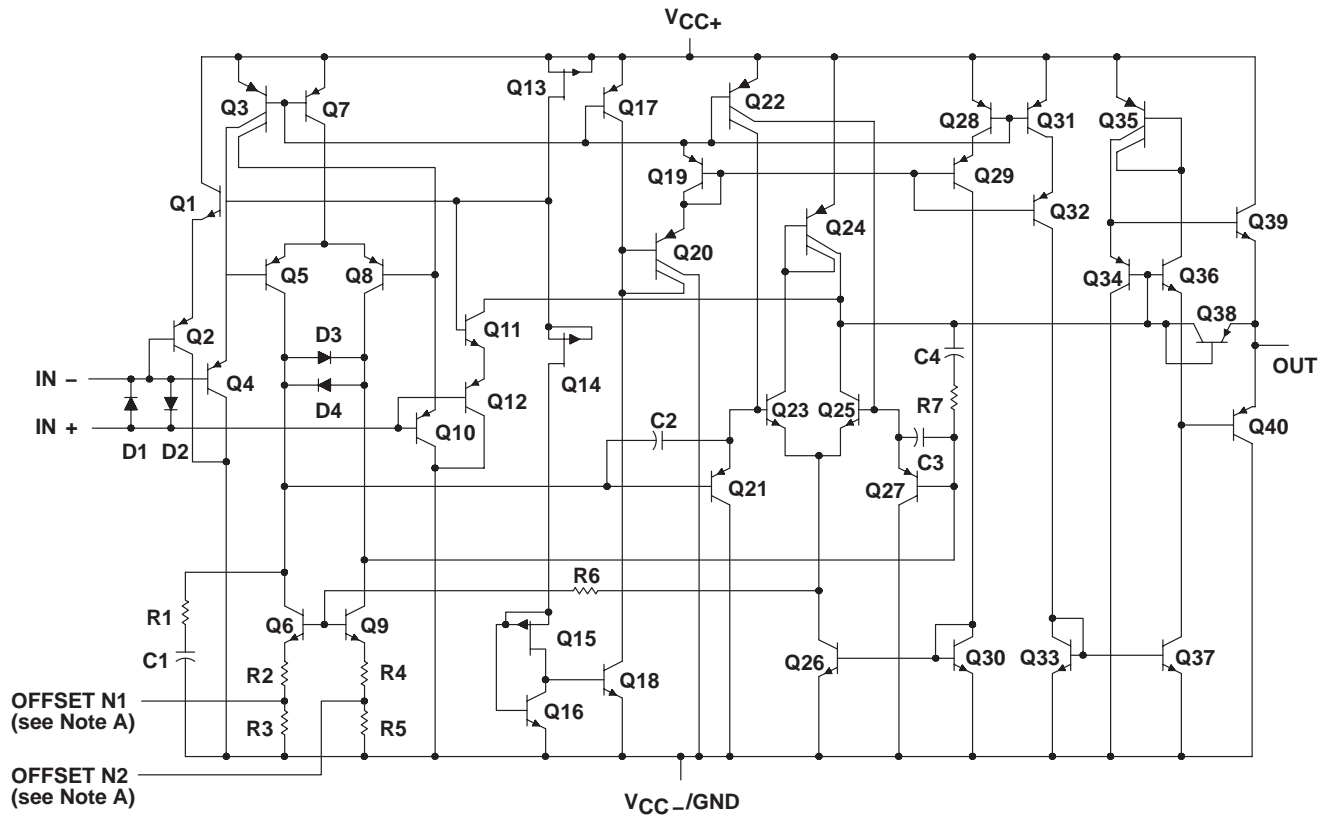

ACTUAL DEVICE COMPONENT COUNT			
COMPONENT	TLE2021	TLE2022	TLE2024
Transistors	40	80	160
Resistors	7	14	28
Diodes	4	8	16
Capacitors	4	8	16

TLE202x-EP, TLE202xA-EP EXCALIBUR HIGH-SPEED LOW-POWER PRECISION OPERATIONAL AMPLIFIERS

SGLS235B– FEBRUARY 2004 – REVISED JUNE 2007

absolute maximum ratings over operating free-air temperature range (unless otherwise noted)†

Supply voltage, V_{CC+} (see Note 1)	20 V
Supply voltage, V_{CC-} (see Note 1)	–20 V
Differential input voltage, V_{ID} (see Note 2)	± 0.6 V
Input voltage range, V_I (any input, see Note 1)	$\pm V_{CC}$
Input current, I_I (each input)	± 1 mA
Output current, I_O (each output): TLE2021	± 20 mA
TLE2022	± 30 mA
TLE2024	± 40 mA
Total current into V_{CC+}	80 mA
Total current out of V_{CC-}	80 mA
Duration of short-circuit current at (or below) 25°C (see Note 3)	unlimited
Operating free-air temperature range, T_A : Q suffix	–40°C to 125°C
Operating virtual junction temperature, T_J	150°C
Package thermal impedance, $R_{\theta JA}$ (see Notes 4 and 5): D (8-pin)	97°C/W
DW (16-pin)	57°C/W
Storage temperature range, T_{stg}	–65°C to 150°C
Lead temperature 1,6 mm (1/16 inch) from case for 3 seconds: D package	300°C

† Stresses beyond those listed under “absolute maximum ratings” may cause permanent damage to the device. These are stress ratings only, and functional operation of the device at these or any other conditions beyond those indicated under “recommended operating conditions” is not implied. Exposure to absolute-maximum-rated conditions for extended periods may affect device reliability.

- NOTES:
- All voltage values, except differential voltages, are with respect to the midpoint between V_{CC+} , and V_{CC-} .
 - Differential voltages are at $IN+$ with respect to $IN-$. Excessive current flows if a differential input voltage in excess of approximately ± 600 mV is applied between the inputs unless some limiting resistance is used.
 - The output may be shorted to either supply. Temperature and/or supply voltages must be limited to ensure that the maximum dissipation rating is not exceeded.
 - Maximum power dissipation is a function of $T_J(\max)$, θ_{JA} , and T_A . The maximum allowable power dissipation at any allowable ambient temperature is $P_D = (T_J(\max) - T_A)/\theta_{JA}$. Selecting the maximum of 150°C can affect reliability.
 - The package thermal impedance is calculated in accordance with JESD 51-7.

recommended operating conditions

		MIN	MAX	UNIT
Supply voltage, V_{CC}		± 2	± 20	V
Common-mode input voltage, V_{IC}	$V_{CC} = \pm 5$ V	0	3.2	V
	$V_{CC\pm} = \pm 15$ V	–15	13.2	
Operating free-air temperature, T_A		–40	125	°C



TLE202x-EP, TLE202xA-EP
EXCALIBUR HIGH-SPEED LOW-POWER PRECISION
OPERATIONAL AMPLIFIERS

SGLS235B– FEBRUARY 2004 – REVISED JUNE 2007

TLE2021 electrical characteristics at specified free-air temperature, $V_{CC} = 5\text{ V}$ (unless otherwise noted)

PARAMETER	TEST CONDITIONS	T_A †	TLE2021-EP			TLE2021A-EP			UNIT
			MIN	TYP	MAX	MIN	TYP	MAX	
V_{IO} Input offset voltage	$V_{IC} = 0, \quad R_S = 50\ \Omega$	25°C	120	600		100	400	μV	
		Full range			800		550		
$\alpha_{V_{IO}}$ Temperature coefficient of input offset voltage		Full range		2			2	$\mu\text{V}/^\circ\text{C}$	
Input offset voltage long-term drift (see Note 4)		25°C		0.005			0.005	$\mu\text{V}/\text{mo}$	
I_{IO} Input offset current		25°C		0.2	6		0.2	6	nA
		Full range			10			10	
I_{IB} Input bias current		25°C		25	70		25	70	nA
	Full range			90			90		
V_{ICR} Common-mode input voltage range	$R_S = 50\ \Omega$	25°C	0 to 3.5	-0.3 to 4		0 to 3.5	-0.3 to 4	V	
		Full range	0 to 3.2			0 to 3.2			
V_{OH} High-level output voltage	$R_L = 10\ \text{k}\Omega$	25°C	4	4.3		4	4.3	V	
Full range			3.8			3.8			
V_{OL} Low-level output voltage		25°C		0.7	0.8		0.7	0.8	V
		Full range			0.95			0.95	
A_{VD} Large-signal differential voltage amplification	$V_O = 1.4\text{ V to }4\text{ V}, \quad R_L = 10\ \text{k}\Omega$	25°C	0.3	1.5		0.3	1.5	$\text{V}/\mu\text{V}$	
		Full range		0.1			0.1		
CMRR Common-mode rejection ratio	$V_{IC} = V_{ICR\text{min}}, \quad R_S = 50\ \Omega$	25°C	85	110		85	110	dB	
		Full range		80			80		
k_{SVR} Supply-voltage rejection ratio ($\Delta V_{CC\pm} / \Delta V_{IO}$)	$V_{CC} = 5\text{ V to }30\text{ V}$	25°C	105	120		105	120	dB	
		Full range		100			100		
I_{CC} Supply current	$V_O = 2.5\text{ V}, \quad \text{No load}$	25°C		170	300		170	300	μA
		Full range			300			300	
ΔI_{CC} Supply current change over operating temperature range		Full range			9			9	μA

† Full range is -40°C to 125°C .

NOTE 4: Typical values are based on the input offset voltage shift observed through 168 hours of operating life test at $T_A = 150^\circ\text{C}$ extrapolated to $T_A = 25^\circ\text{C}$ using the Arrhenius equation and assuming an activation energy of 0.96 eV.



TLE202x-EP, TLE202xA-EP EXCALIBUR HIGH-SPEED LOW-POWER PRECISION OPERATIONAL AMPLIFIERS

SGLS235B– FEBRUARY 2004 – REVISED JUNE 2007

TLE2021 electrical characteristics at specified free-air temperature, $V_{CC} = \pm 15\text{ V}$ (unless otherwise noted)

PARAMETER	TEST CONDITIONS	T_A †	TLE2021-EP			TLE2021A-EP			UNIT
			MIN	TYP	MAX	MIN	TYP	MAX	
V_{IO} Input offset voltage	$V_{IC} = 0,$ $R_S = 50\ \Omega$	25°C	120	500		80	300	μV	
		Full range		700			450		
α_{VIO} Temperature coefficient of input offset voltage		Full range	2			2		$\mu\text{V}/^\circ\text{C}$	
Input offset voltage long-term drift (see Note 4)		25°C	0.006			0.006		$\mu\text{V}/\text{mo}$	
I_{IO} Input offset current		25°C	0.2	6		0.2	6	nA	
		Full range		10			10		
I_{IB} Input bias current		25°C	25	70		25	70	nA	
	Full range		90			90			
V_{ICR} Common-mode input voltage range	$R_S = 50\ \Omega$	25°C	-15 to 13.5	-15.3 to 14		-15 to 13.5	-15.3 to 14	V	
		Full range	-15 to 13.2			-15 to 13.2			
V_{OM+} Maximum positive peak output voltage swing	$R_L = 10\ \text{k}\Omega$	25°C	14	14.3		14	14.3	V	
		Full range	13.8			13.8			
V_{OM-} Maximum negative peak output voltage swing		25°C	-13.7	-14.1		-13.7	-14.1	V	
		Full range	-13.6			-13.6			
A_{VD} Large-signal differential voltage amplification	$V_O = \pm 0\ \text{V},$ $R_L = 10\ \text{k}\Omega$	25°C	1	6.5		1	6.5	$\text{V}/\mu\text{V}$	
		Full range	0.5			0.5			
CMRR Common-mode rejection ratio	$V_{IC} = V_{ICR\text{min}},$ $R_S = 50\ \Omega$	25°C	100	115		100	115	dB	
		Full range	96			96			
k_{SVR} Supply-voltage rejection ratio ($\Delta V_{CC\pm}/\Delta V_{IO}$)	$V_{CC\pm} = \pm 2.5\ \text{V to } \pm 15\ \text{V}$	25°C	105	120		105	120	dB	
		Full range	100			100			
I_{CC} Supply current	$V_O = 0,$ No load	25°C	200	350		200	350	μA	
		Full range		350			350		
ΔI_{CC} Supply current change over operating temperature range		Full range		10			10	μA	

† Full range is -40°C to 125°C .

NOTE 4: Typical values are based on the input offset voltage shift observed through 168 hours of operating life test at $T_A = 150^\circ\text{C}$ extrapolated to $T_A = 25^\circ\text{C}$ using the Arrhenius equation and assuming an activation energy of 0.96 eV.



TLE202x-EP, TLE202xA-EP EXCALIBUR HIGH-SPEED LOW-POWER PRECISION OPERATIONAL AMPLIFIERS

SGLS235B– FEBRUARY 2004 – REVISED JUNE 2007

TLE2022 electrical characteristics at specified free-air temperature, $V_{CC} = 5\text{ V}$ (unless otherwise noted)

PARAMETER	TEST CONDITIONS	T_A †	TLE2022-EP			TLE2022A-EP			UNIT
			MIN	TYP	MAX	MIN	TYP	MAX	
V_{IO} Input offset voltage	$V_{IC} = 0,$ $R_S = 50\ \Omega$	25°C	600			400			μV
		Full range	800			550			
α_{VIO} Temperature coefficient of input offset voltage		Full range	2			2			$\mu\text{V}/^\circ\text{C}$
Input offset voltage long-term drift (see Note 4)		25°C	0.005			0.005			$\mu\text{V}/\text{mo}$
I_{IO} Input offset current		25°C	0.5	6		0.4	6		nA
		Full range	10			10			
I_{IB} Input bias current	25°C	35	70		33	70		nA	
	Full range	90			90				
V_{ICR} Common-mode input voltage range	$R_S = 50\ \Omega$	25°C	0 to 3.5	–0.3 to 4	0 to 3.5	–0.3 to 4	V		
		Full range	0 to 3.2		0 to 3.2				
V_{OH} High-level output voltage	$R_L = 10\ \text{k}\Omega$	25°C	4	4.3		4	4.3		V
		Full range	3.8			3.8			
V_{OL} Low-level output voltage		25°C	0.7		0.8	0.7		0.8	V
		Full range	0.95			0.95			
A_{VD} Large-signal differential voltage amplification	$V_O = 1.4\text{ V to }4\text{ V},$ $R_L = 10\ \text{k}\Omega$	25°C	0.3	1.5		0.4	1.5		$\text{V}/\mu\text{V}$
		Full range	0.1			0.1			
CMRR Common-mode rejection ratio	$V_{IC} = V_{ICRmin},$ $R_S = 50\ \Omega$	25°C	85	100		87	102		dB
		Full range	80			82			
k_{SVR} Supply-voltage rejection ratio ($\Delta V_{CC\pm}/\Delta V_{IO}$)	$V_{CC} = 5\text{ V to }30\text{ V}$	25°C	100	115		103	118		dB
		Full range	95			98			
I_{CC} Supply current	$V_O = 2.5\text{ V},$ No load	25°C	450		600		450 600		μA
		Full range	600			600			
ΔI_{CC} Supply current change over operating temperature range		Full range	37			37			μA

† Full range is -40°C to 125°C .

NOTE 4: Typical values are based on the input offset voltage shift observed through 168 hours of operating life test at $T_A = 150^\circ\text{C}$ extrapolated to $T_A = 25^\circ\text{C}$ using the Arrhenius equation and assuming an activation energy of 0.96 eV.

TLE202x-EP, TLE202xA-EP EXCALIBUR HIGH-SPEED LOW-POWER PRECISION OPERATIONAL AMPLIFIERS

SGLS235B– FEBRUARY 2004 – REVISED JUNE 2007

TLE2022 electrical characteristics at specified free-air temperature, $V_{CC} = \pm 15\text{ V}$ (unless otherwise noted)

PARAMETER	TEST CONDITIONS	T_A †	TLE2022-EP			TLE2022A-EP			UNIT
			MIN	TYP	MAX	MIN	TYP	MAX	
V_{IO} Input offset voltage	$V_{IC} = 0,$ $R_S = 50\ \Omega$	25°C	150	500		120	300	μV	
		Full range			700		450		
αV_{IO} Temperature coefficient of input offset voltage		Full range		2			2	$\mu\text{V}/^\circ\text{C}$	
Input offset voltage long-term drift (see Note 4)		25°C		0.006			0.006	$\mu\text{V}/\text{mo}$	
I_{IO} Input offset current		25°C		0.5	6		0.4	6	nA
		Full range			10			10	
I_{IB} Input bias current		25°C		35	70		33	70	nA
	Full range			90			90		
V_{ICR} Common-mode input voltage range	$R_S = 50\ \Omega$	25°C	-15 to 13.5	-15.3 to 14		-15 to 13.5	-15.3 to 14	V	
		Full range	-15 to 13.2			-15 to 13.2			
V_{OM+} Maximum positive peak output voltage swing	$R_L = 10\ \text{k}\Omega$	25°C	14	14.3		14	14.3	V	
		Full range	13.8			13.8			
V_{OM-} Maximum negative peak output voltage swing		25°C	-13.7	-14.1		-13.7	-14.1	V	
		Full range	-13.6			-13.6			
A_{VD} Large-signal differential voltage amplification	$V_O = \pm 10\ \text{V},$ $R_L = 10\ \text{k}\Omega$	25°C	0.8	4		1	7	$\text{V}/\mu\text{V}$	
		Full range	0.8			1			
CMRR Common-mode rejection ratio	$V_{IC} = V_{ICR\text{min}},$ $R_S = 50\ \Omega$	25°C	95	106		97	109	dB	
		Full range	91			93			
k_{SVR} Supply-voltage rejection ratio ($\Delta V_{CC\pm} / \Delta V_{IO}$)	$V_{CC\pm} = \pm 2.5\ \text{V to } \pm 15\ \text{V}$	25°C	100	115		103	118	dB	
		Full range	95			98			
I_{CC} Supply current	$V_O = 0,$ No load	25°C		550	700		550	700	μA
		Full range			700			700	
ΔI_{CC} Supply current change over operating temperature range		Full range		60			60	μA	

† Full range is -40°C to 125°C .

NOTE 4: Typical values are based on the input offset voltage shift observed through 168 hours of operating life test at $T_A = 150^\circ\text{C}$ extrapolated to $T_A = 25^\circ\text{C}$ using the Arrhenius equation and assuming an activation energy of 0.96 eV.



TLE202x-EP, TLE202xA-EP
EXCALIBUR HIGH-SPEED LOW-POWER PRECISION
OPERATIONAL AMPLIFIERS

SGLS235B– FEBRUARY 2004 – REVISED JUNE 2007

TLE2024 electrical characteristics at specified free-air temperature, $V_{CC} = 5\text{ V}$ (unless otherwise noted)

PARAMETER	TEST CONDITIONS	T_A †	TLE2024-EP			TLE2024A-EP			UNIT
			MIN	TYP	MAX	MIN	TYP	MAX	
V_{IO} Input offset voltage	$V_{IC} = 0, R_S = 50\ \Omega$	25°C	1100			850			μV
		Full range	1300			1050			
α_{VIO} Temperature coefficient of input offset voltage		Full range	2			2			$\mu\text{V}/^\circ\text{C}$
Input offset voltage long-term drift (see Note 4)		25°C	0.005			0.005			$\mu\text{V}/\text{mo}$
I_{IO} Input offset current		25°C	0.6	6		0.5	6	nA	
		Full range	10			10			
I_{IB} Input bias current	25°C	45	70		40	70	nA		
	Full range	90			90				
V_{ICR} Common-mode input voltage range	$R_S = 50\ \Omega$	25°C	0 to 3.5	–0.3 to 4		0 to 3.5	–0.3 to 4	V	
		Full range	0 to 3.2			0 to 3.2			
V_{OH} High-level output voltage	$R_L = 10\ \text{k}\Omega$	25°C	3.9	4.2		3.9	4.2	V	
		Full range	3.7			3.7			
V_{OL} Low-level output voltage		25°C	0.7	0.8		0.7	0.8	V	
		Full range	0.95			0.95			
A_{VD} Large-signal differential voltage amplification	$V_O = 1.4\text{ V to }4\text{ V}, R_L = 10\ \text{k}\Omega$	25°C	0.2	1.5		0.3	1.5	$\text{V}/\mu\text{V}$	
		Full range	0.1			0.1			
CMRR Common-mode rejection ratio	$V_{IC} = V_{ICRmin}, R_S = 50\ \Omega$	25°C	80	90		82	92	dB	
		Full range	80			82			
k_{SVR} Supply-voltage rejection ratio ($\Delta V_{CC\pm}/\Delta V_{IO}$)	$V_{CC\pm} = \pm 2.5\text{ V to } \pm 15\text{ V}$	25°C	98	112		100	115	dB	
		Full range	93			95			
I_{CC} Supply current	$V_O = 0, \text{ No load}$	25°C	800	1200		800	1200	μA	
		Full range	1200			1200			
ΔI_{CC} Supply current change over operating temperature range		Full range	50			50			μA

† Full range is -40°C to 125°C .

NOTE 4: Typical values are based on the input offset voltage shift observed through 168 hours of operating life test at $T_A = 150^\circ\text{C}$ extrapolated to $T_A = 25^\circ\text{C}$ using the Arrhenius equation and assuming an activation energy of 0.96 eV.

TLE202x-EP, TLE202xA-EP EXCALIBUR HIGH-SPEED LOW-POWER PRECISION OPERATIONAL AMPLIFIERS

SGLS235B– FEBRUARY 2004 – REVISED JUNE 2007

TLE2024 electrical characteristics at specified free-air temperature, $V_{CC} = \pm 15\text{ V}$ (unless otherwise noted)

PARAMETER	TEST CONDITIONS	T_A †	TLE2024-EP			TLE2024A-EP			UNIT
			MIN	TYP	MAX	MIN	TYP	MAX	
V_{IO} Input offset voltage	$V_{IC} = 0,$ $R_S = 50\ \Omega$	25°C	1000			750			μV
		Full range	1200			950			
α_{VIO} Temperature coefficient of input offset voltage		Full range	2			2			$\mu\text{V}/^\circ\text{C}$
Input offset voltage long-term drift (see Note 4)		25°C	0.006			0.006			$\mu\text{V}/\text{mo}$
I_{IO} Input offset current		25°C	0.6	6		0.2	6		nA
		Full range	10			10			
I_{IB} Input bias current		25°C	50	70		45	70		nA
	Full range	90			90				
V_{ICR} Common-mode input voltage range	$R_S = 50\ \Omega$	25°C	-15 to 13.5	-15.3 to 14	-15 to 13.5	-15.3 to 14	V		
		Full range	-15 to 13.2		-15 to 13.2				
V_{OM+} Maximum positive peak output voltage swing	$R_L = 10\ \text{k}\Omega$	25°C	13.8	14.1		13.8	14.2		V
		Full range	13.7			13.7			
V_{OM-} Maximum negative peak output voltage swing		25°C	-13.7	-14.1		-13.7	-14.1		V
		Full range	-13.6			-13.6			
A_{VD} Large-signal differential voltage amplification	$V_O = \pm 10\ \text{V},$ $R_L = 10\ \text{k}\Omega$	25°C	0.4	2		0.8	4		$\text{V}/\mu\text{V}$
		Full range	0.4			0.8			
$CMRR$ Common-mode rejection ratio	$V_{IC} = V_{ICRmin},$ $R_S = 50\ \Omega$	25°C	92	102		94	105		dB
		Full range	88			90			
k_{SVR} Supply-voltage rejection ratio ($\Delta V_{CC\pm}/\Delta V_{IO}$)	$V_{CC\pm} = \pm 2.5\ \text{V to } \pm 15\ \text{V}$	25°C	98	112		100	115		dB
		Full range	93			95			
I_{CC} Supply current	$V_O = 0,$ No load	25°C	1050	1400		1050	1400		μA
		Full range	1400			1400			
ΔI_{CC} Supply current change over operating temperature range		Full range	85			85			μA

† Full range is -40°C to 125°C .

NOTE 4: Typical values are based on the input offset voltage shift observed through 168 hours of operating life test at $T_A = 150^\circ\text{C}$ extrapolated to $T_A = 25^\circ\text{C}$ using the Arrhenius equation and assuming an activation energy of 0.96 eV.



TLE202x-EP, TLE202xA-EP
EXCALIBUR HIGH-SPEED LOW-POWER PRECISION
OPERATIONAL AMPLIFIERS

SGLS235B– FEBRUARY 2004 – REVISED JUNE 2007

TLE2021 operating characteristics, $V_{CC} = 5\text{ V}$, $T_A = 25^\circ\text{C}$

PARAMETER		TEST CONDITIONS	T_A	MIN	TYP	MAX	UNIT
SR	Slew rate at unity gain	$V_O = 1\text{ V to }3\text{ V}$, See Figure 1	25°C		0.5		$\text{V}/\mu\text{s}$
V_n	Equivalent input noise voltage (see Figure 2)	$f = 10\text{ Hz}$	25°C		21		nV/Hz
		$f = 1\text{ kHz}$	25°C		17		
$V_{N(PP)}$	Peak-to-peak equivalent input noise voltage	$f = 0.1\text{ to }1\text{ Hz}$	25°C		0.16		μV
		$f = 0.1\text{ to }10\text{ Hz}$	25°C		0.47		
I_n	Equivalent input noise current		25°C		0.9		pA/Hz
B_1	Unity-gain bandwidth	See Figure 3	25°C		1.2		MHz
ϕ_m	Phase margin at unity gain	See Figure 3	25°C		42°		

TLE2021 operating characteristics at specified free-air temperature, $V_{CC} = \pm 15\text{ V}$

PARAMETER		TEST CONDITIONS	T_A^\dagger	MIN	TYP	MAX	UNIT
SR	Slew rate at unity gain	$V_O = \pm 10\text{ V}$, See Figure 1	25°C	0.45	0.65		$\text{V}/\mu\text{s}$
			Full range	0.4			
V_n	Equivalent input noise voltage (see Figure 2)		$f = 10\text{ Hz}$	25°C	19		nV/Hz
			$f = 1\text{ kHz}$	25°C	15		
$V_{N(PP)}$	Peak-to-peak equivalent input noise voltage		$f = 0.1\text{ to }1\text{ Hz}$	25°C	0.16		μV
			$f = 0.1\text{ to }10\text{ Hz}$	25°C	0.47		
I_n	Equivalent input noise current		25°C		0.09		pA/Hz
B_1	Unity-gain bandwidth	See Figure 3	25°C		2		MHz
ϕ_m	Phase margin at unity gain	See Figure 3	25°C		46°		

† Full range is -40°C to 125°C for the Q-suffix devices.

TLE2022 operating characteristics, $V_{CC} = 5\text{ V}$, $T_A = 25^\circ\text{C}$

PARAMETER		TEST CONDITIONS	MIN	TYP	MAX	UNIT
SR	Slew rate at unity gain	$V_O = 1\text{ V to }3\text{ V}$, See Figure 1		0.5		$\text{V}/\mu\text{s}$
V_n	Equivalent input noise voltage (see Figure 2)	$f = 10\text{ Hz}$		21		$\text{nV}/\sqrt{\text{Hz}}$
		$f = 1\text{ kHz}$		17		
$V_{N(PP)}$	Peak-to-peak equivalent input noise voltage	$f = 0.1\text{ to }1\text{ Hz}$		0.16		μV
		$f = 0.1\text{ to }10\text{ Hz}$		0.47		
I_n	Equivalent input noise current			0.1		$\text{pA}/\sqrt{\text{Hz}}$
B_1	Unity-gain bandwidth	See Figure 3		1.7		MHz
ϕ_m	Phase margin at unity gain	See Figure 3		47°		



TLE202x-EP, TLE202xA-EP EXCALIBUR HIGH-SPEED LOW-POWER PRECISION OPERATIONAL AMPLIFIERS

SGLS235B– FEBRUARY 2004 – REVISED JUNE 2007

TLE2022 operating characteristics at specified free-air temperature, $V_{CC} = \pm 15\text{ V}$

PARAMETER		TEST CONDITIONS	T_A^\dagger	MIN	TYP	MAX	UNIT
SR	Slew rate at unity gain	$V_O = \pm 10\text{ V}$, See Figure 1	25°C	0.45	0.65		V/ μs
			Full range	0.4			
V_n	Equivalent input noise voltage (see Figure 2)	f = 10 Hz	25°C		19		nV/ $\sqrt{\text{Hz}}$
		f = 1 kHz	25°C		15		
$V_{N(PP)}$	Peak-to-peak equivalent input noise voltage	f = 0.1 to 1 Hz	25°C		0.16		μV
		f = 0.1 to 10 Hz	25°C		0.47		
I_n	Equivalent input noise current		25°C		0.1		pA/ $\sqrt{\text{Hz}}$
B_1	Unity-gain bandwidth	See Figure 3	25°C		2.8		MHz
ϕ_m	Phase margin at unity gain	See Figure 3	25°C		52°		

† Full range is -40°C to 125°C .

TLE2024 operating characteristics, $V_{CC} = 5\text{ V}$, $T_A = 25^\circ\text{C}$

PARAMETER		TEST CONDITIONS	MIN	TYP	MAX	UNIT
SR	Slew rate at unity gain	$V_O = 1\text{ V}$ to 3 V , See Figure 1		0.5		V/ μs
V_n	Equivalent input noise voltage (see Figure 2)	f = 10 Hz		21		nV/ $\sqrt{\text{Hz}}$
		f = 1 kHz		17		
$V_{N(PP)}$	Peak-to-peak equivalent input noise voltage	f = 0.1 to 1 Hz		0.16		μV
		f = 0.1 to 10 Hz		0.47		
I_n	Equivalent input noise current			0.1		pA/ $\sqrt{\text{Hz}}$
B_1	Unity-gain bandwidth	See Figure 3		1.7		MHz
ϕ_m	Phase margin at unity gain	See Figure 3		47°		

TLE2024 operating characteristics at specified free-air temperature, $V_{CC} = \pm 15\text{ V}$ (unless otherwise noted)

PARAMETER		TEST CONDITIONS	T_A^\dagger	MIN	TYP	MAX	UNIT
SR	Slew rate at unity gain	$V_O = \pm 10\text{ V}$, See Figure 1	25°C	0.45	0.7		V/ μs
			Full range	0.4			
V_n	Equivalent input noise voltage (see Figure 2)	f = 10 Hz	25°C		19		nV/ $\sqrt{\text{Hz}}$
		f = 1 kHz	25°C		15		
$V_{N(PP)}$	Peak-to-peak equivalent input noise voltage	f = 0.1 to 1 Hz	25°C		0.16		μV
		f = 0.1 to 10 Hz	25°C		0.47		
I_n	Equivalent input noise current		25°C		0.1		pA/ $\sqrt{\text{Hz}}$
B_1	Unity-gain bandwidth	See Figure 3	25°C		2.8		MHz
ϕ_m	Phase margin at unity gain	See Figure 3	25°C		52°		

† Full range is -40°C to 125°C .



PARAMETER MEASUREMENT INFORMATION

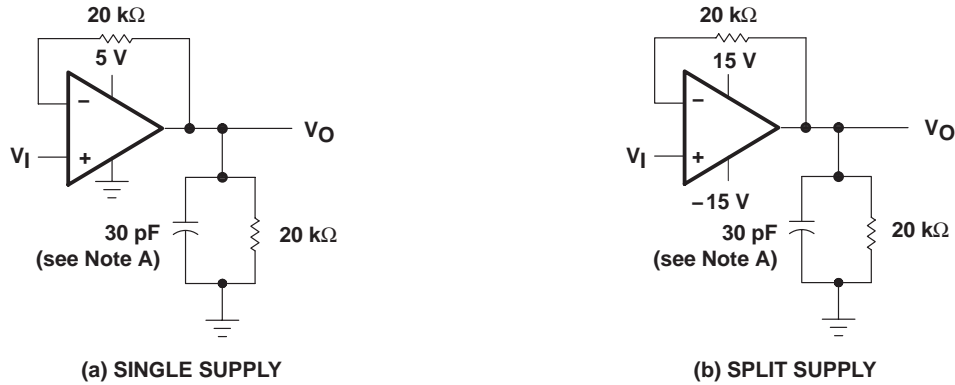

NOTE A: C_L includes fixture capacitance.

Figure 1. Slew-Rate Test Circuit

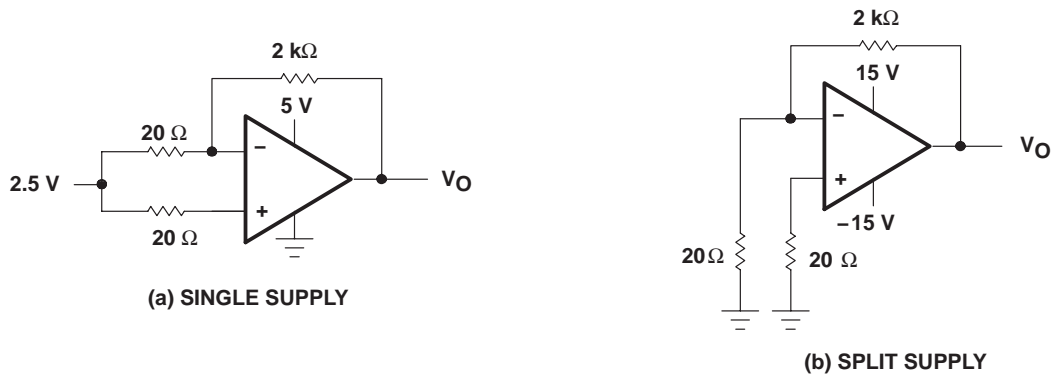
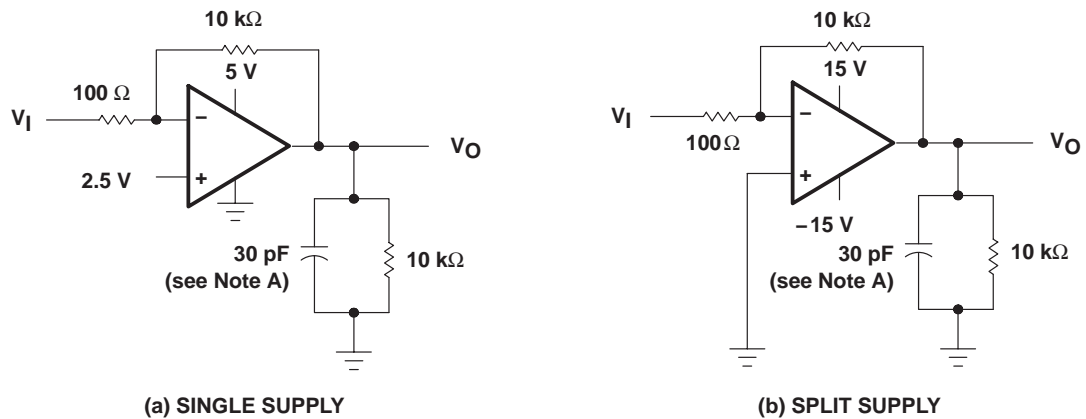

Figure 2. Noise-Voltage Test Circuit



NOTE A: C_L includes fixture capacitance.

Figure 3. Unity-Gain Bandwidth and Phase-Margin Test Circuit

TLE202x-EP, TLE202xA-EP EXCALIBUR HIGH-SPEED LOW-POWER PRECISION OPERATIONAL AMPLIFIERS

SGLS235B – FEBRUARY 2004 – REVISED JUNE 2007

PARAMETER MEASUREMENT INFORMATION

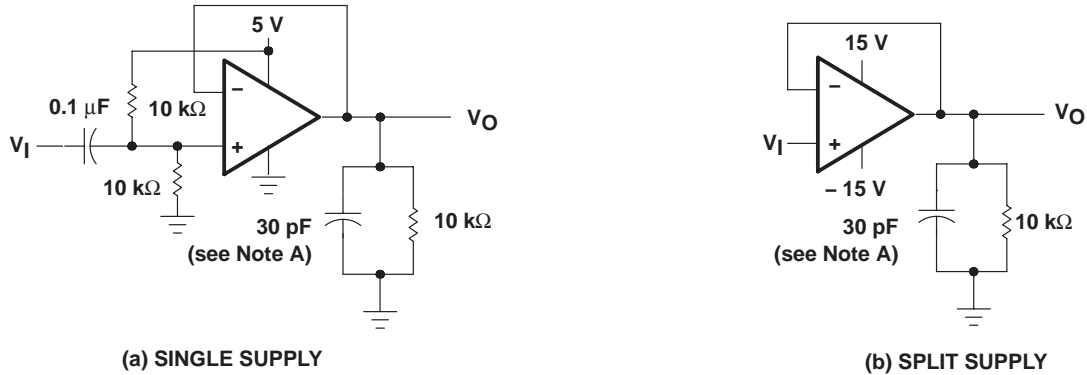

NOTE A: C_L includes fixture capacitance.

Figure 4. Small-Signal Pulse-Response Test Circuit

typical values

Typical values presented in this data sheet represent the median (50% point) of device parametric performance.

TLE202x-EP, TLE202xA-EP
EXCALIBUR HIGH-SPEED LOW-POWER PRECISION
OPERATIONAL AMPLIFIERS

SGLS235B – FEBRUARY 2004 – REVISED JUNE 2007

TYPICAL CHARACTERISTICS

Table of Graphs

			FIGURE
V_{IO}	Input offset voltage	Distribution	5, 6, 7
I_{IB}	Input bias current	vs Common-mode input voltage vs Free-air temperature	8, 9, 10 11, 12, 13
I_I	Input current	vs Differential input voltage	14
V_{OM}	Maximum peak output voltage	vs Output current vs Free-air temperature	15, 16, 17 18
V_{OH}	High-level output voltage	vs High-level output current vs Free-air temperature	19, 20 21
V_{OL}	Low-level output voltage	vs Low-level output current vs Free-air temperature	22 23
$V_{O(PP)}$	Maximum peak-to-peak output voltage	vs Frequency	24, 25
A_{VD}	Large-signal differential voltage amplification	vs Frequency vs Free-air temperature	26 27, 28, 29
I_{OS}	Short-circuit output current	vs Supply voltage vs Free-air temperature	30 – 33 34 – 37
I_{CC}	Supply current	vs Supply voltage vs Free-air temperature	38, 39, 40 41, 42, 43
CMRR	Common-mode rejection ratio	vs Frequency	44, 45, 46
SR	Slew rate	vs Free-air temperature	47, 48, 49
	Voltage-follower small-signal pulse response		50, 51
	Voltage-follower large-signal pulse response		52 – 57
$V_{N(PP)}$	Peak-to-peak equivalent input noise voltage	0.1 to 1 Hz 0.1 to 10 Hz	58 59
V_n	Equivalent input noise voltage	vs Frequency	60
B_1	Unity-gain bandwidth	vs Supply voltage vs Free-air temperature	61, 62 63, 64
ϕ_m	Phase margin	vs Supply voltage vs Load capacitance vs Free-air temperature	65, 66 67, 68 69, 70
	Phase shift	vs Frequency	26



TLE202x-EP, TLE202xA-EP EXCALIBUR HIGH-SPEED LOW-POWER PRECISION OPERATIONAL AMPLIFIERS

SGLS235B– FEBRUARY 2004 – REVISED JUNE 2007

TYPICAL CHARACTERISTICS

**DISTRIBUTION OF TLE2021
INPUT OFFSET VOLTAGE**

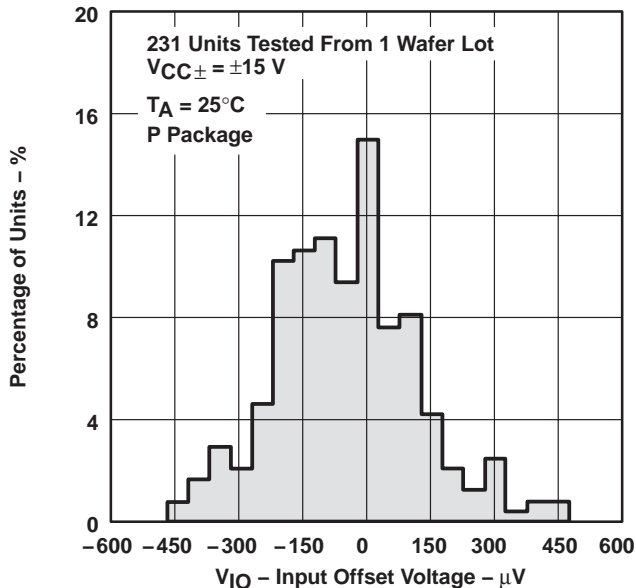

Figure 5

**DISTRIBUTION OF TLE2022
INPUT OFFSET VOLTAGE**

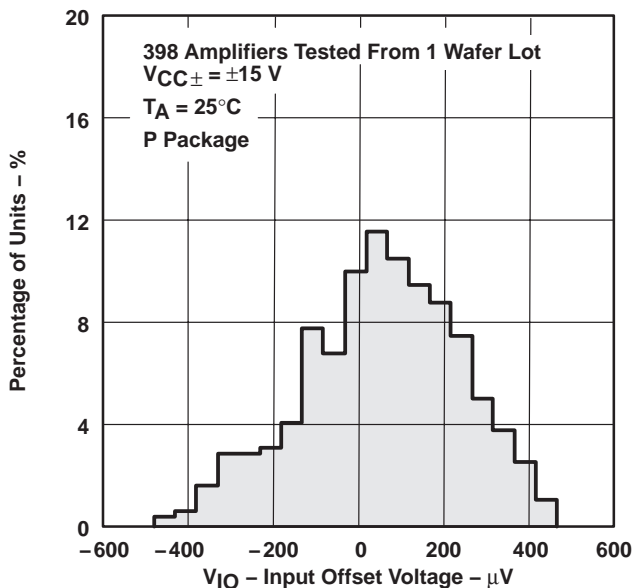

Figure 6

**DISTRIBUTION OF TLE2024
INPUT OFFSET VOLTAGE**

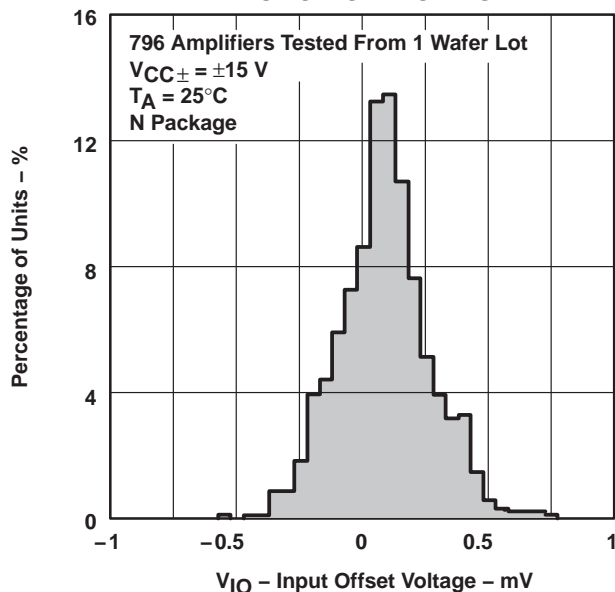

Figure 7

**TLE2021
INPUT BIAS CURRENT
vs**

COMMON-MODE INPUT VOLTAGE

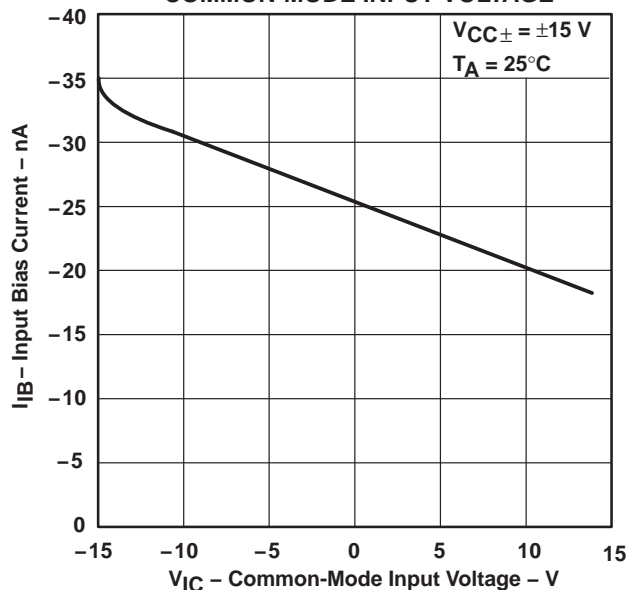
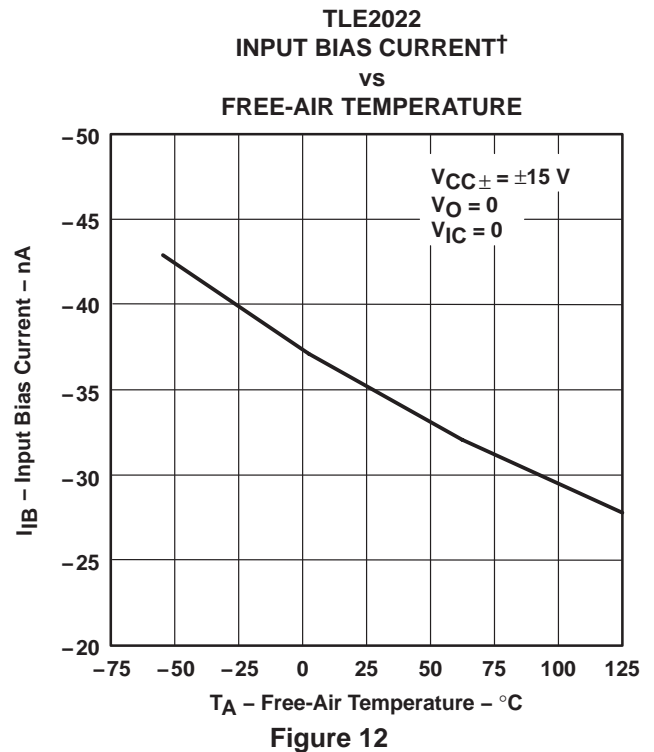
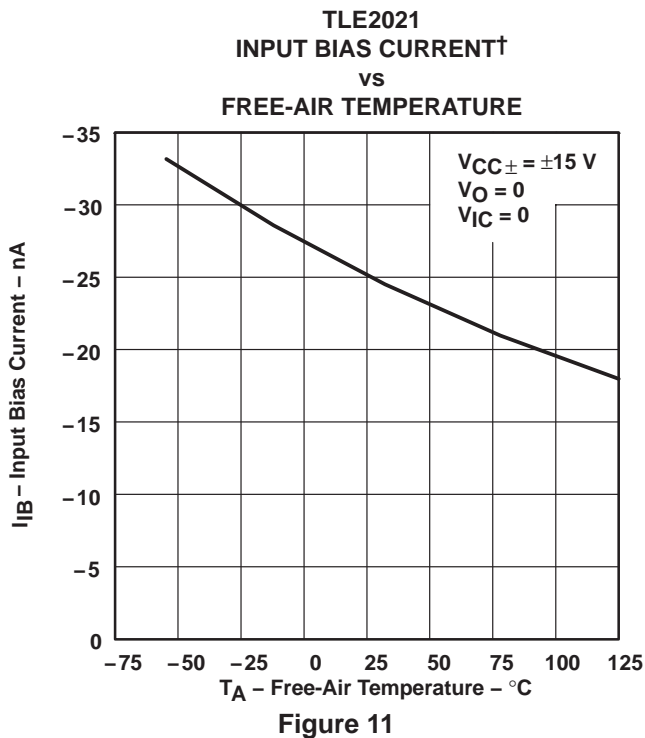
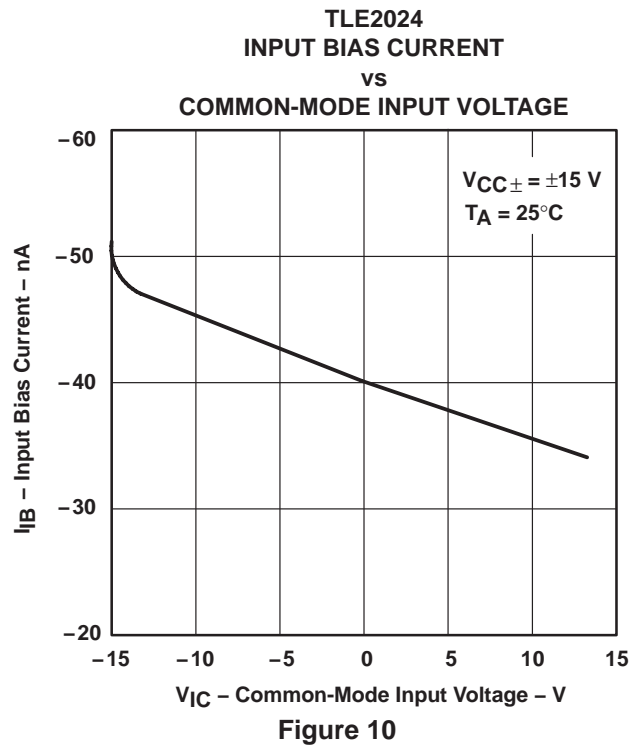
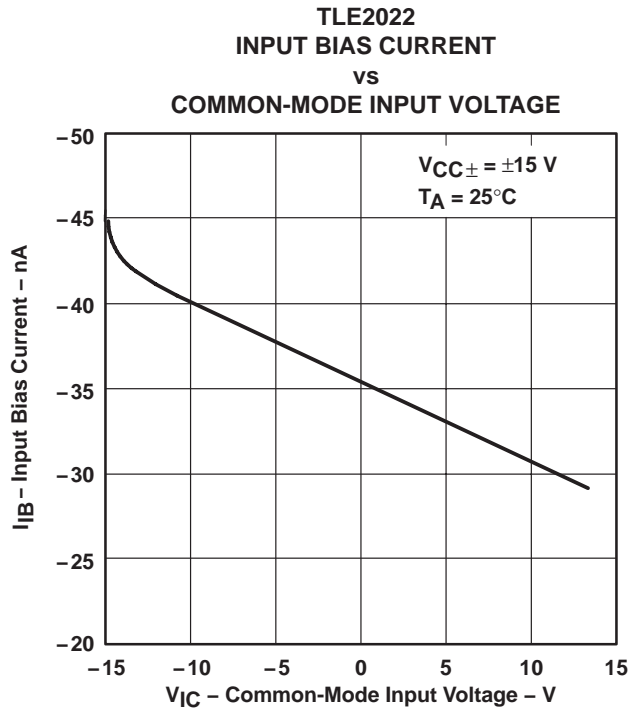

Figure 8

TYPICAL CHARACTERISTICS



† Data at high and low temperatures are applicable only within the rated operating free-air temperature ranges of the various devices.

TLE202x-EP, TLE202xA-EP EXCALIBUR HIGH-SPEED LOW-POWER PRECISION OPERATIONAL AMPLIFIERS

SGLS235B– FEBRUARY 2004 – REVISED JUNE 2007

TYPICAL CHARACTERISTICS

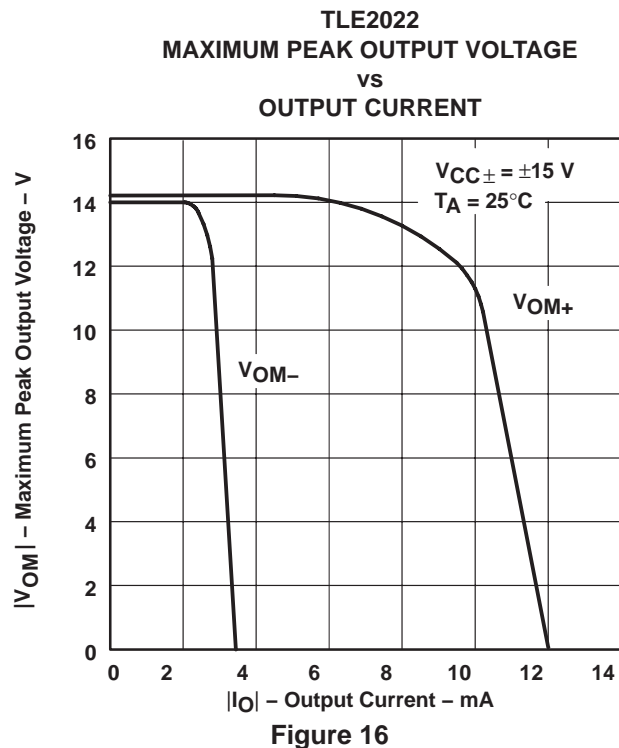
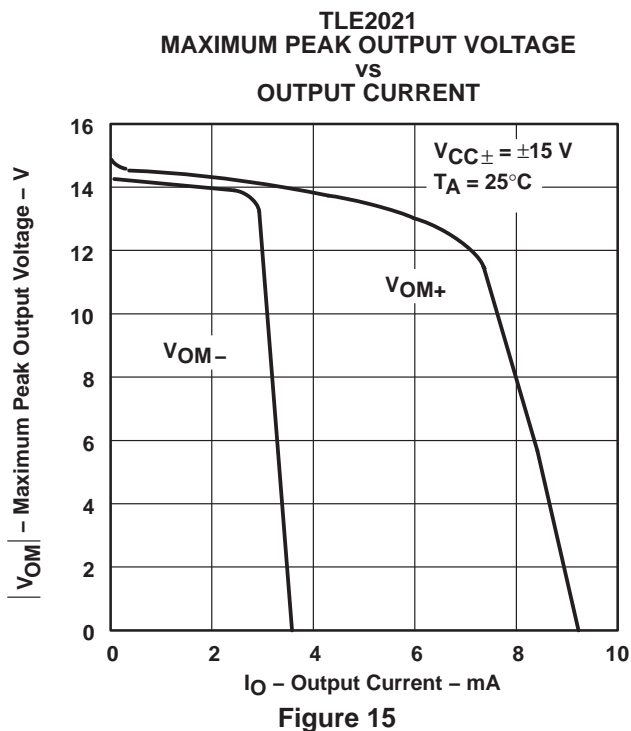
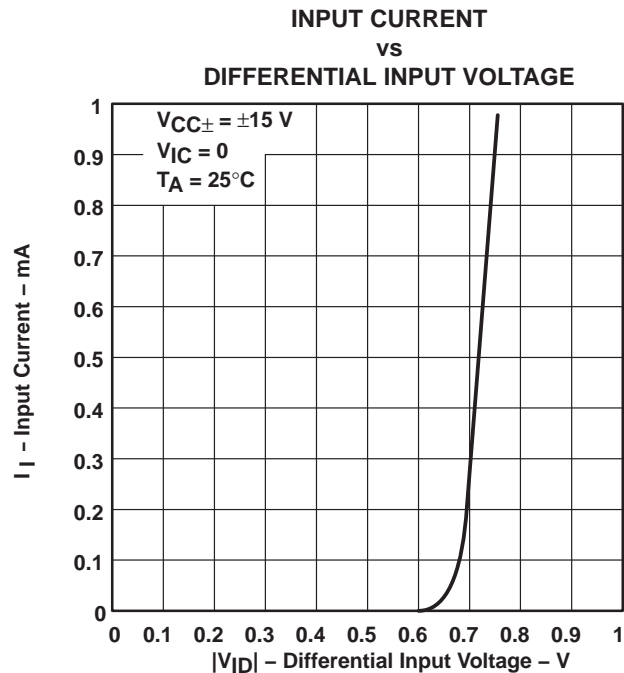
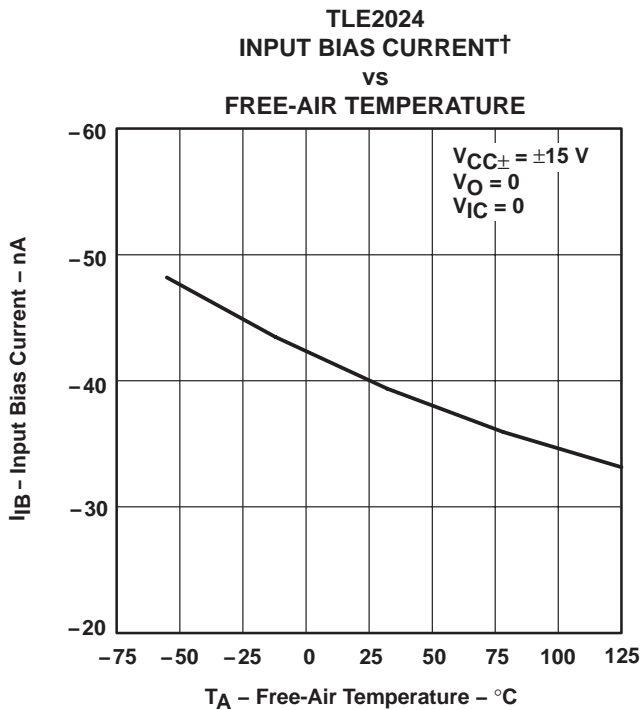

† Data at high and low temperatures are applicable only within the rated operating free-air temperature ranges of the various devices.

TYPICAL CHARACTERISTICS

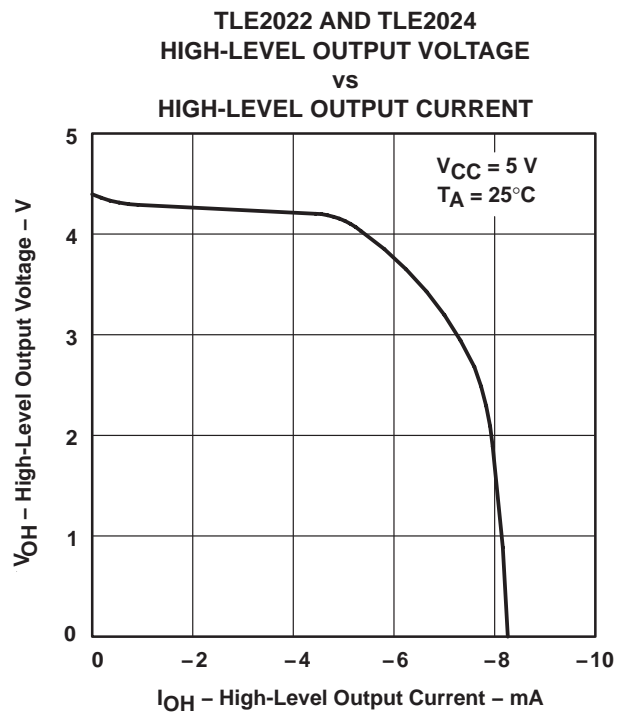
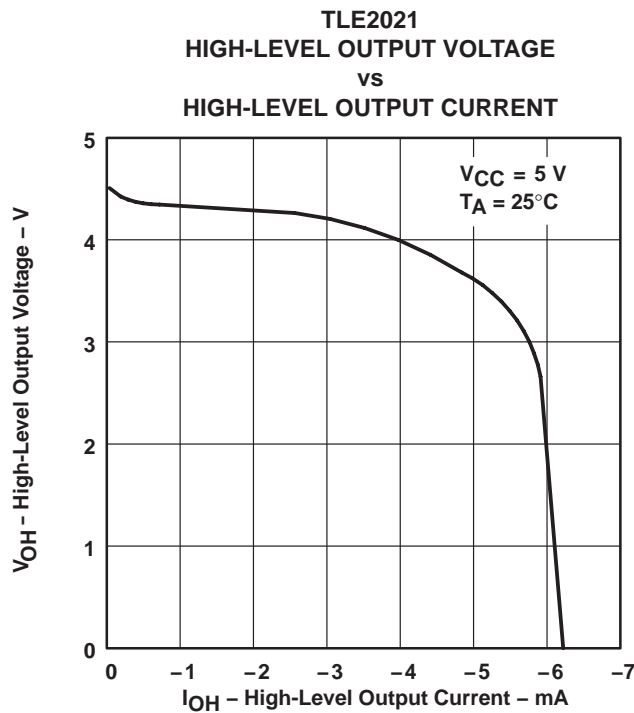
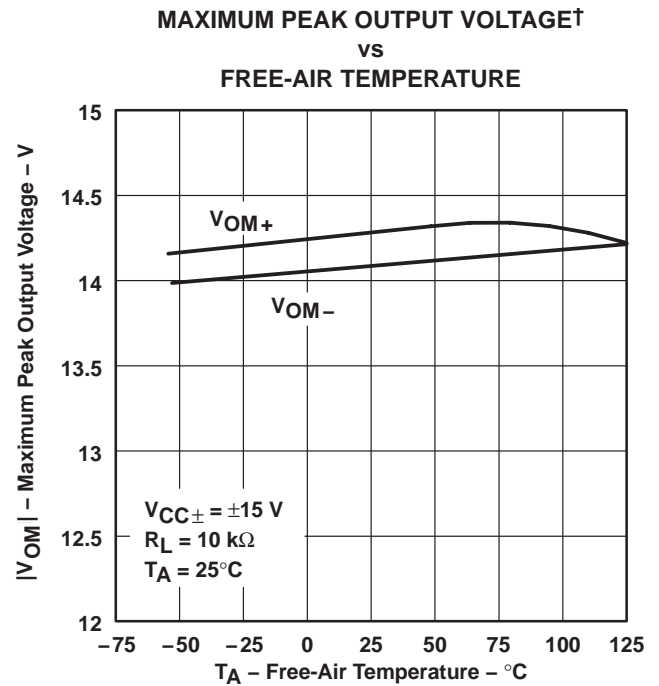
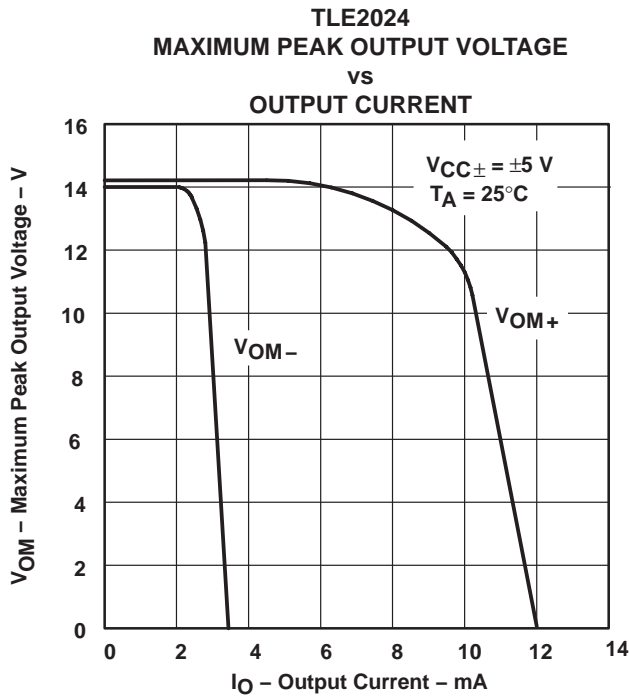

† Data at high and low temperatures are applicable only within the rated operating free-air temperature ranges of the various devices.

TLE202x-EP, TLE202xA-EP
EXCALIBUR HIGH-SPEED LOW-POWER PRECISION
OPERATIONAL AMPLIFIERS

SGLS235B– FEBRUARY 2004 – REVISED JUNE 2007

TYPICAL CHARACTERISTICS

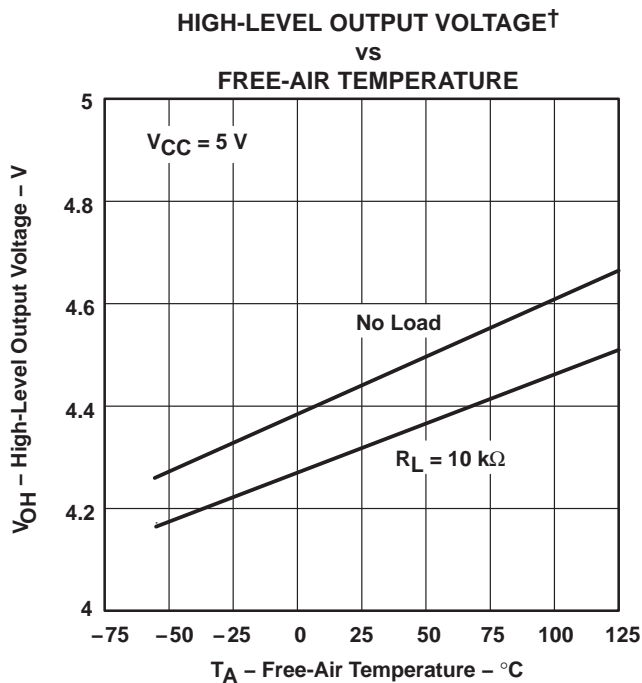

Figure 21

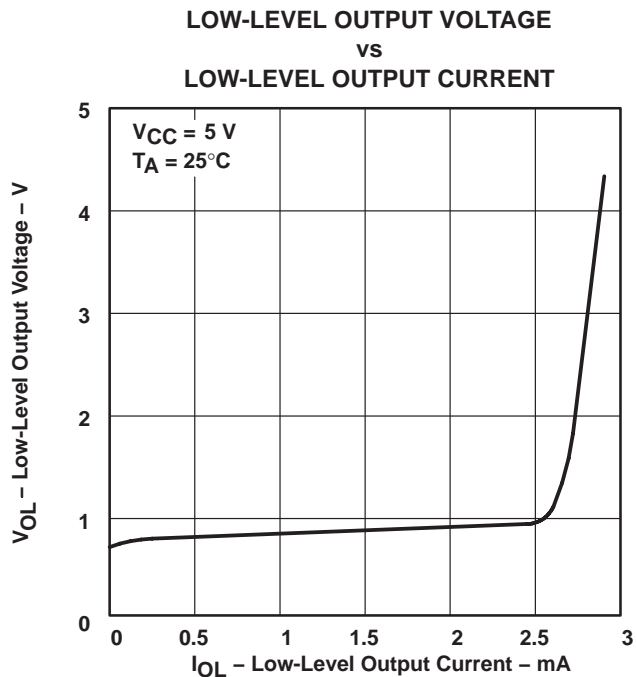

Figure 22

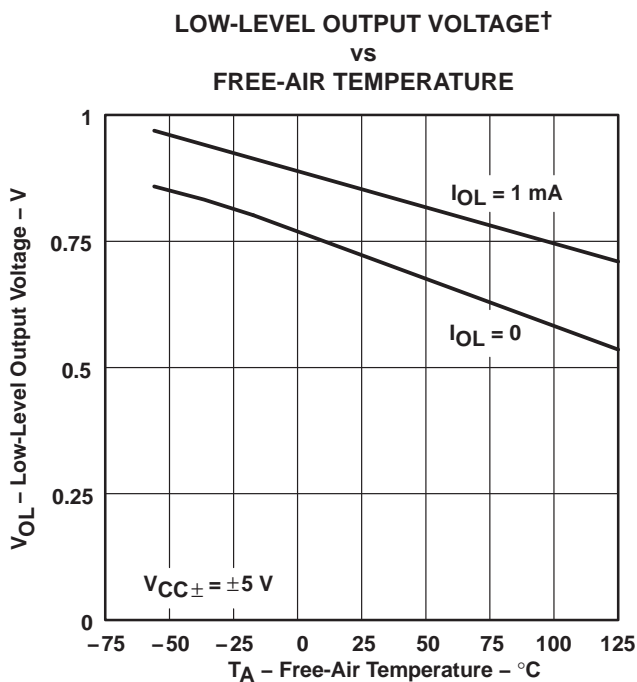

Figure 23

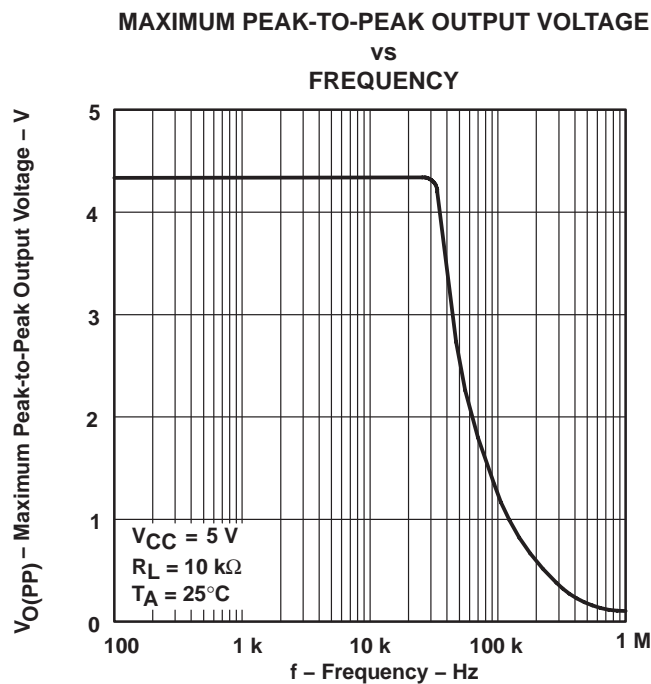

Figure 24

† Data at high and low temperatures are applicable only within the rated operating free-air temperature ranges of the various devices.

TYPICAL CHARACTERISTICS

MAXIMUM PEAK-TO-PEAK OUTPUT VOLTAGE
 vs
 FREQUENCY

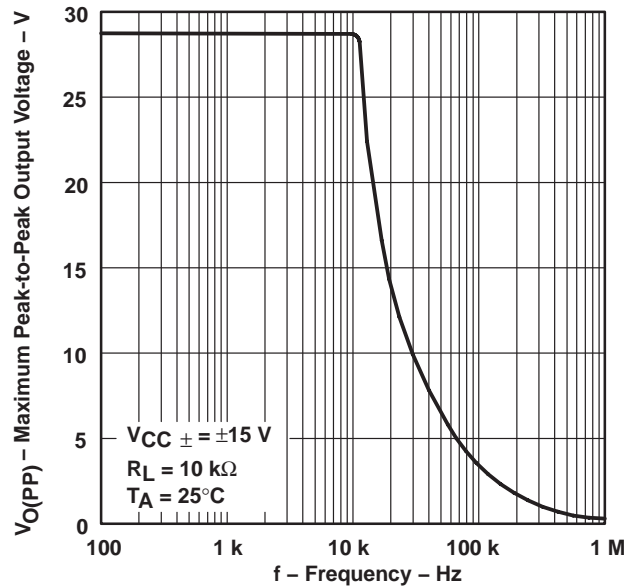

Figure 25

LARGE-SIGNAL DIFFERENTIAL VOLTAGE
 AMPLIFICATION AND PHASE SHIFT
 vs
 FREQUENCY

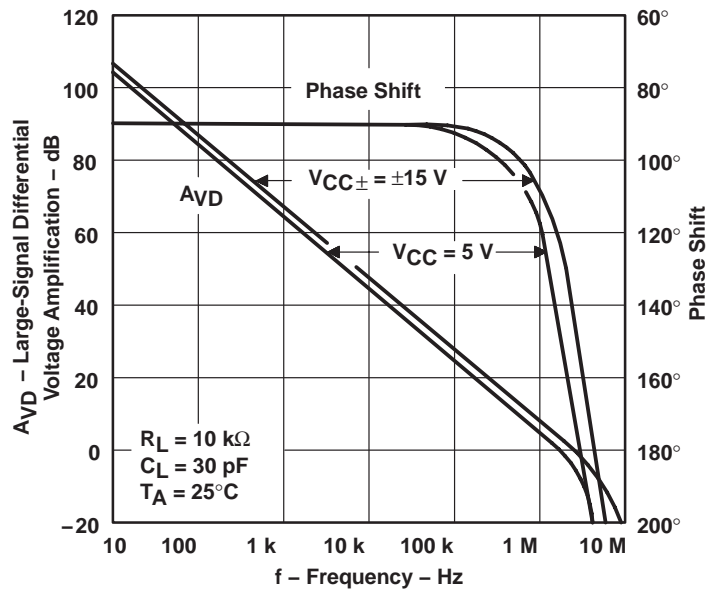
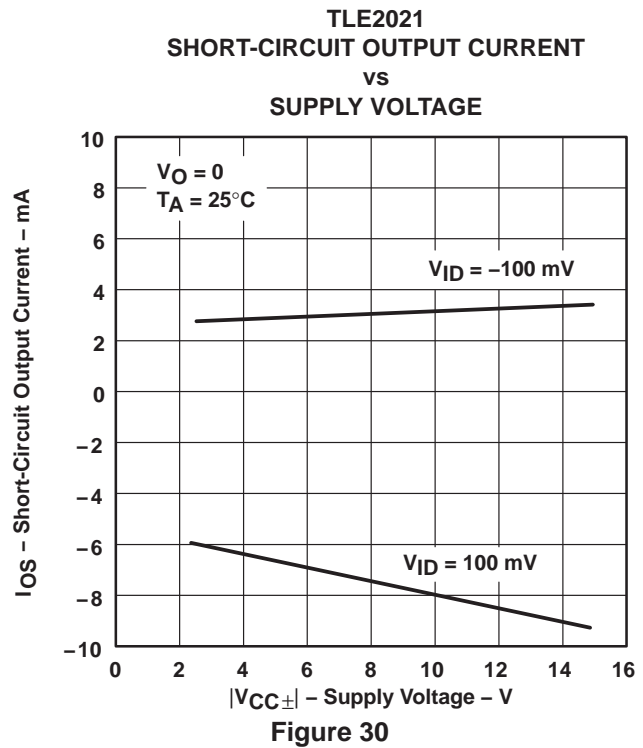
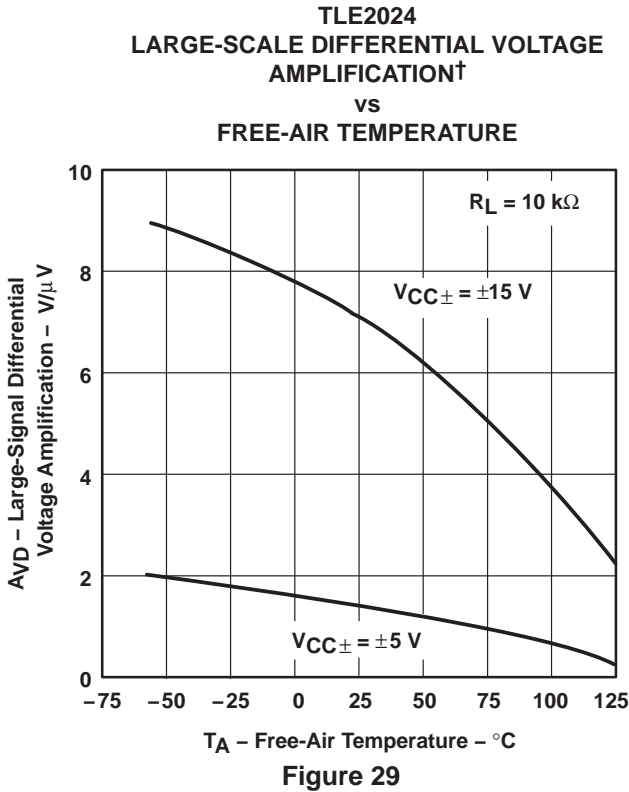
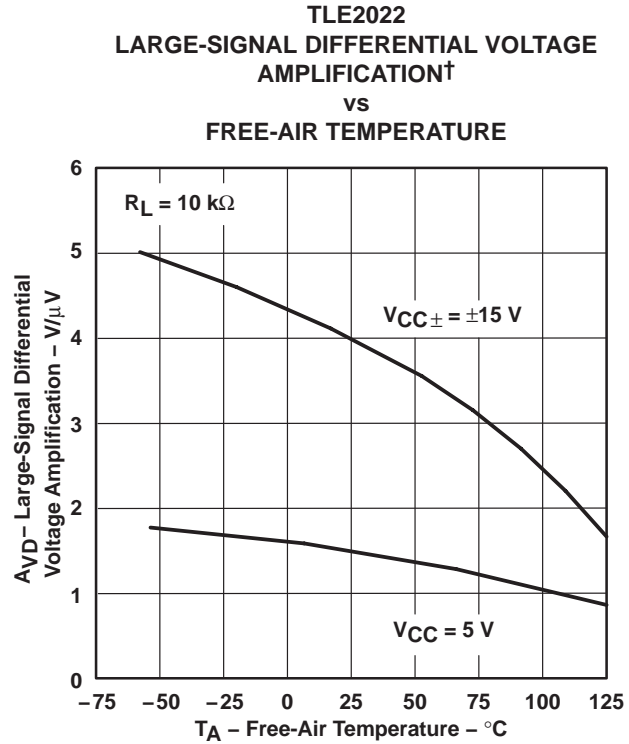
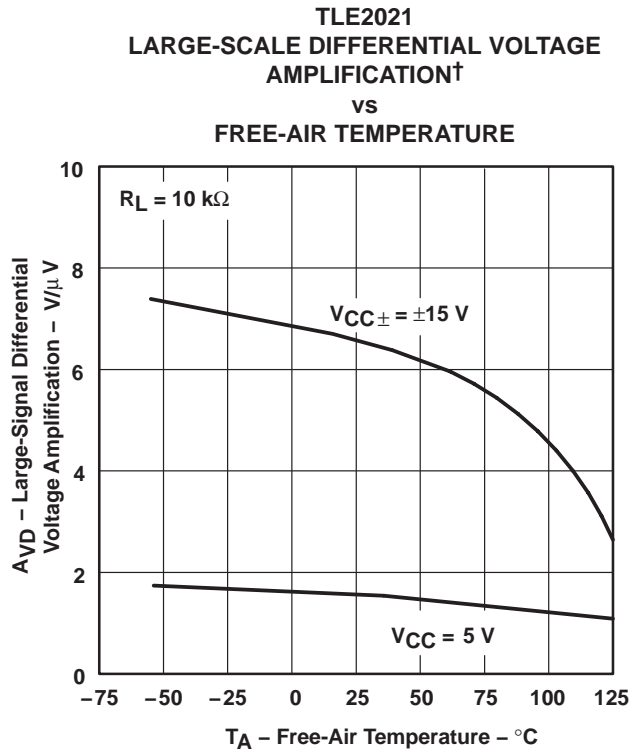

Figure 26

TLE202x-EP, TLE202xA-EP EXCALIBUR HIGH-SPEED LOW-POWER PRECISION OPERATIONAL AMPLIFIERS

SGLS235B– FEBRUARY 2004 – REVISED JUNE 2007

TYPICAL CHARACTERISTICS



† Data at high and low temperatures are applicable only within the rated operating free-air temperature ranges of the various devices.

TYPICAL CHARACTERISTICS

TLE2022 AND TLE2024
SHORT-CIRCUIT OUTPUT CURRENT
vs
SUPPLY VOLTAGE

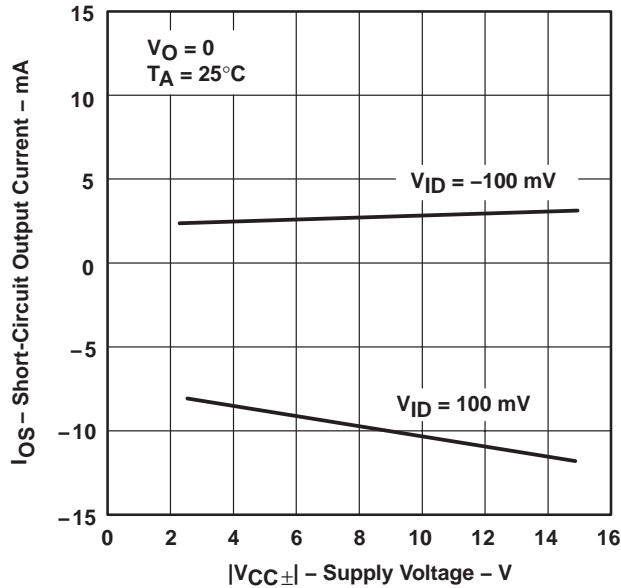

Figure 31

TLE2021
SHORT-CIRCUIT OUTPUT CURRENT
vs
SUPPLY VOLTAGE

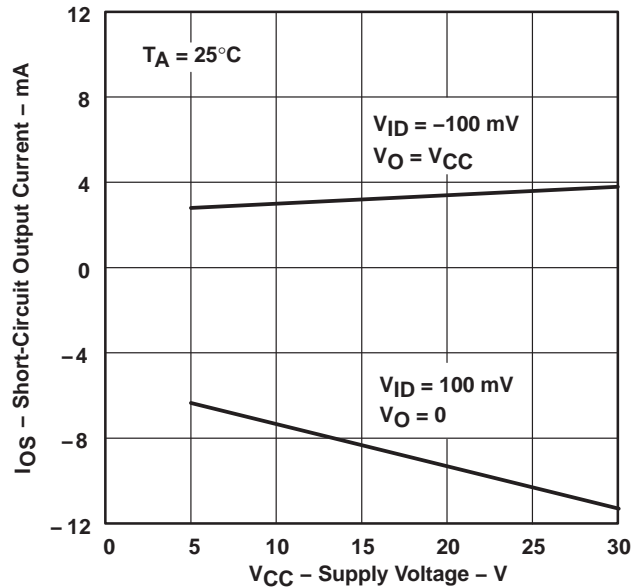

Figure 32

TLE2022 AND TLE2024
SHORT-CIRCUIT OUTPUT CURRENT
vs
SUPPLY VOLTAGE

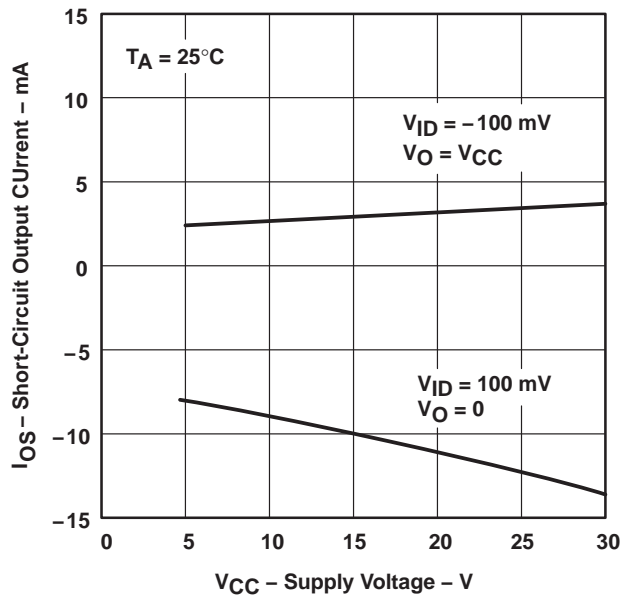

Figure 33

TLE2021
SHORT-CIRCUIT OUTPUT CURRENT†
vs
FREE-AIR TEMPERATURE

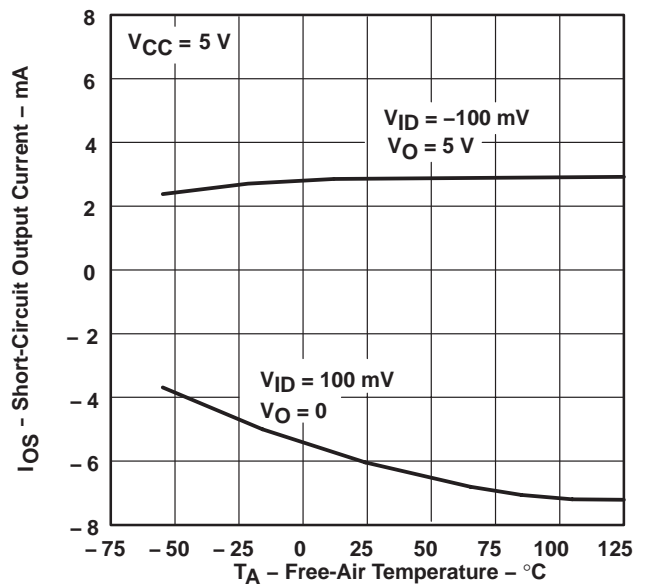

Figure 34

† Data at high and low temperatures are applicable only within the rated operating free-air temperature ranges of the various devices.

**TLE202x-EP, TLE202xA-EP
EXCALIBUR HIGH-SPEED LOW-POWER PRECISION
OPERATIONAL AMPLIFIERS**

SGLS235B– FEBRUARY 2004 – REVISED JUNE 2007

TYPICAL CHARACTERISTICS

**TLE2022 AND TLE2024
SHORT-CIRCUIT OUTPUT CURRENT†
vs
FREE-AIR TEMPERATURE**

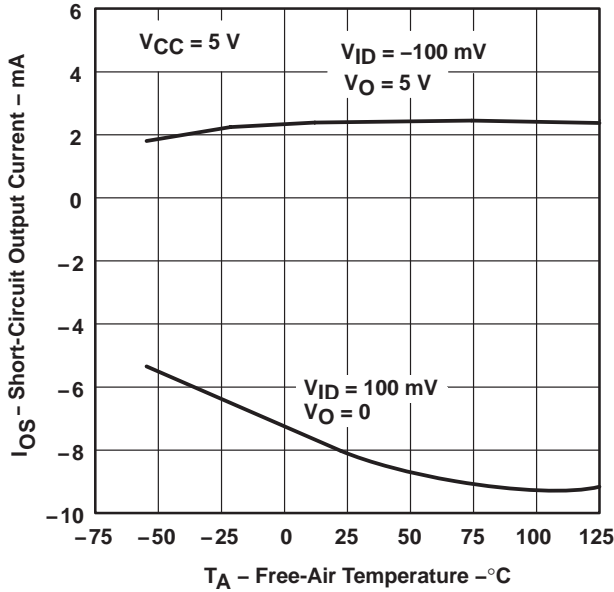

Figure 35

**TLE2021
SHORT-CIRCUIT OUTPUT CURRENT†
vs
FREE-AIR TEMPERATURE**

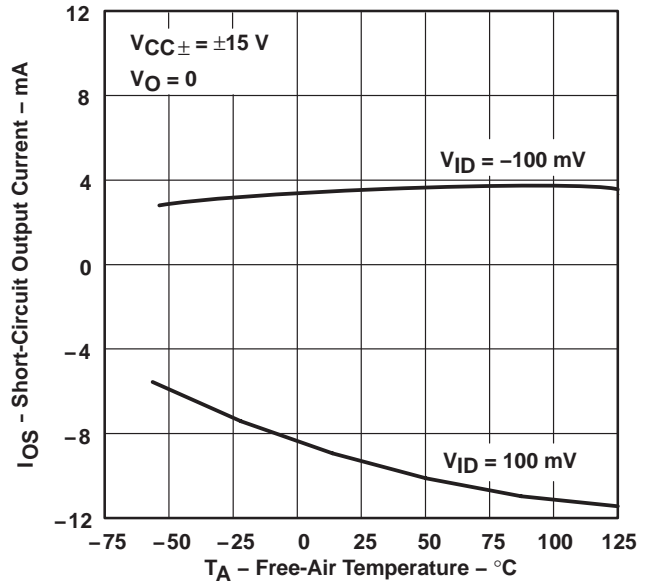

Figure 36

**TLE2022 AND TLE2024
SHORT-CIRCUIT OUTPUT CURRENT†
vs
FREE-AIR TEMPERATURE**

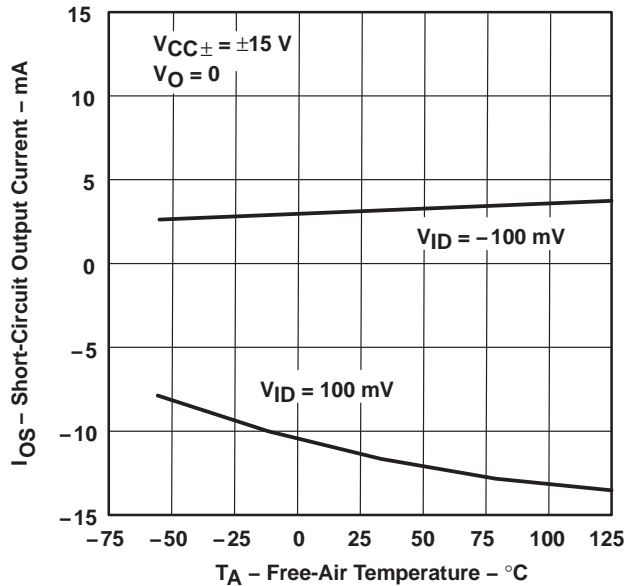

Figure 37

**TLE2021
SUPPLY CURRENT
vs
SUPPLY VOLTAGE**

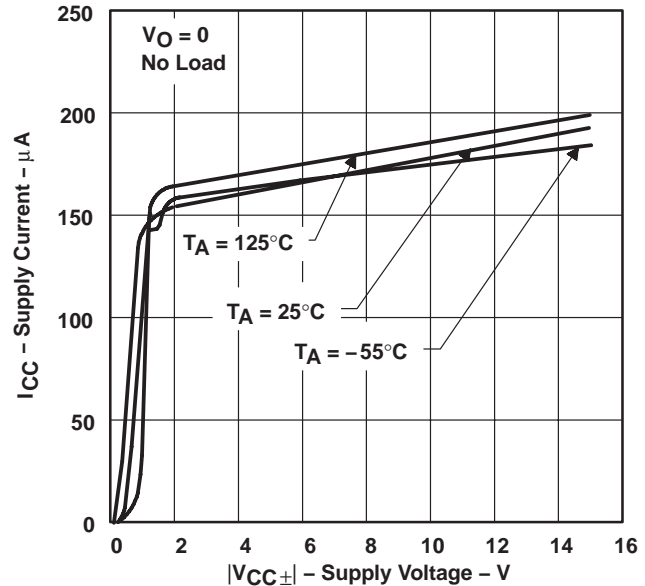

Figure 38

† Data at high and low temperatures are applicable only within the rated operating free-air temperature ranges of the various devices.

TYPICAL CHARACTERISTICS

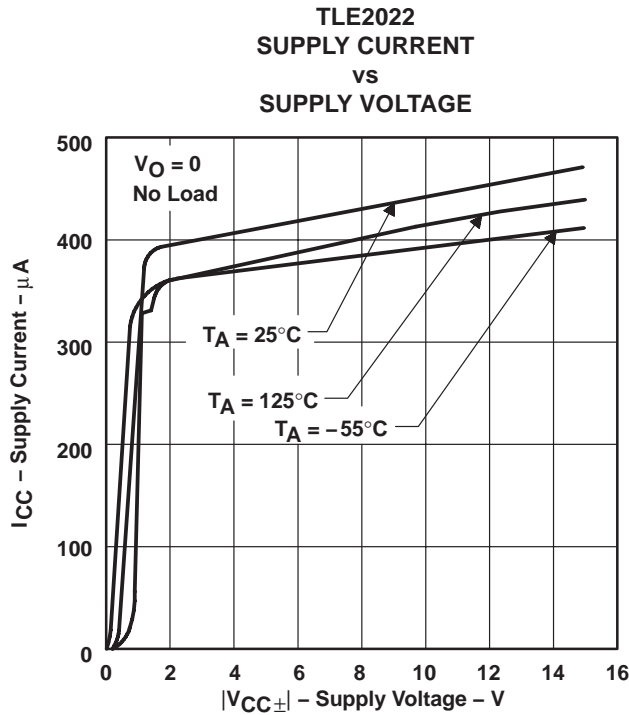

Figure 39

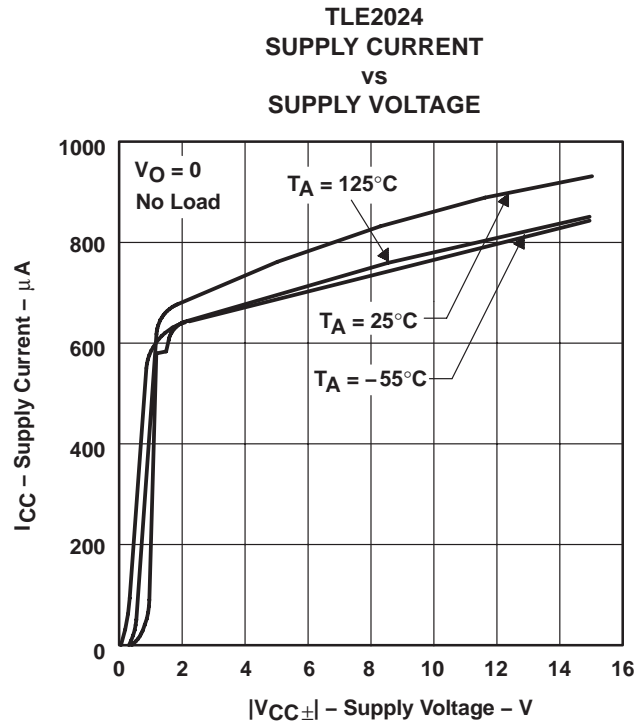

Figure 40

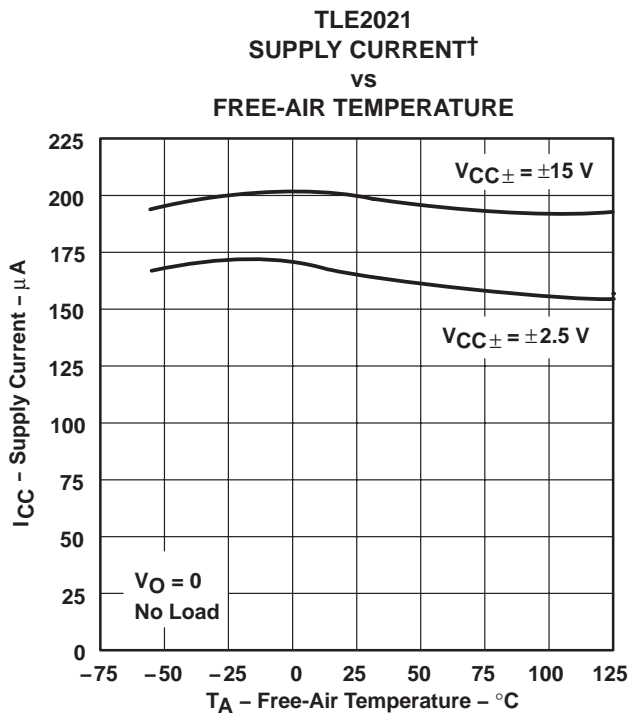

Figure 41

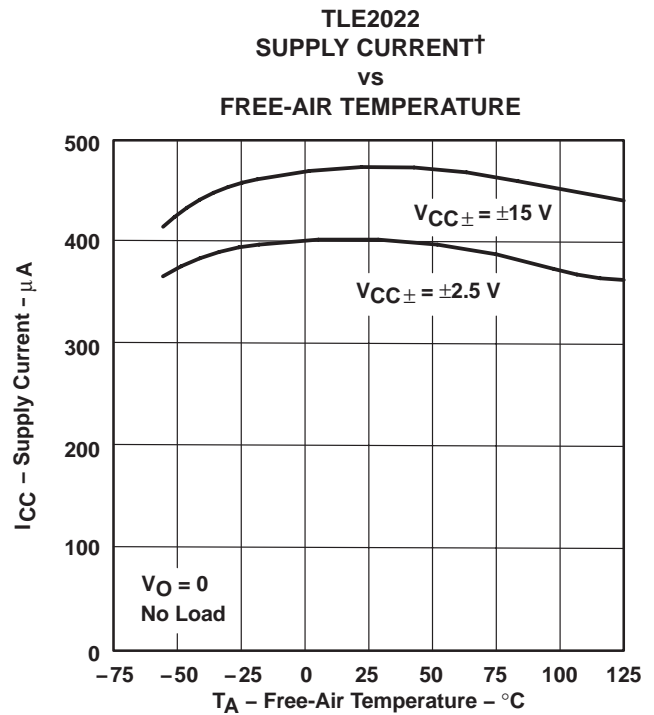

Figure 42

† Data at high and low temperatures are applicable only within the rated operating free-air temperature ranges of the various devices.

TLE202x-EP, TLE202xA-EP EXCALIBUR HIGH-SPEED LOW-POWER PRECISION OPERATIONAL AMPLIFIERS

SGLS235B – FEBRUARY 2004 – REVISED JUNE 2007

TYPICAL CHARACTERISTICS

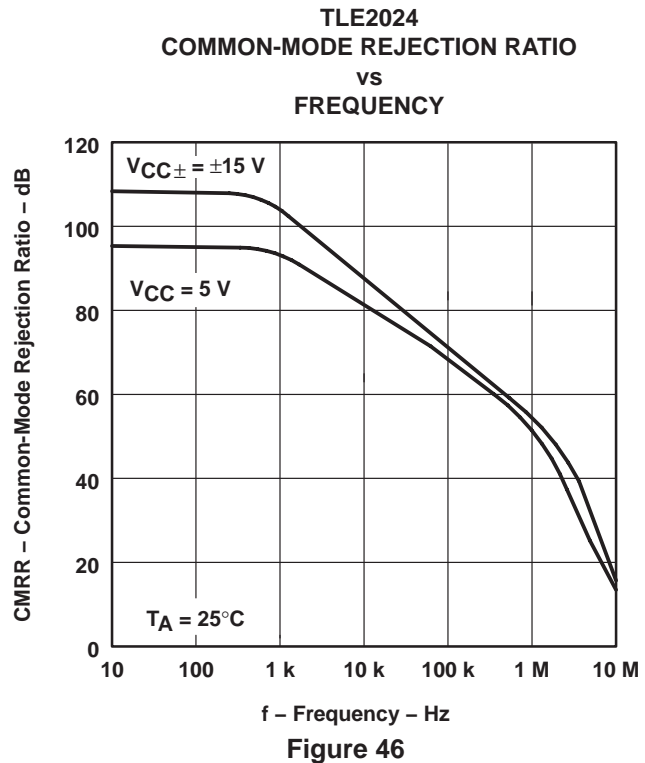
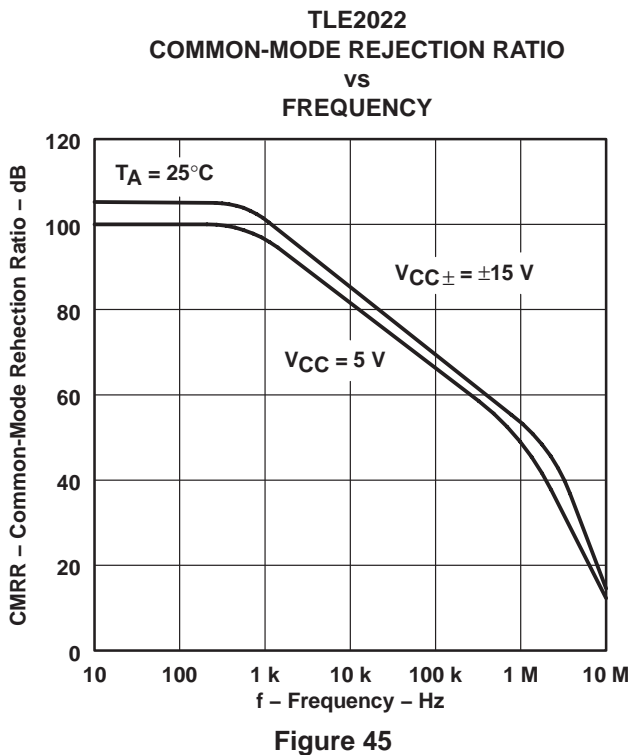
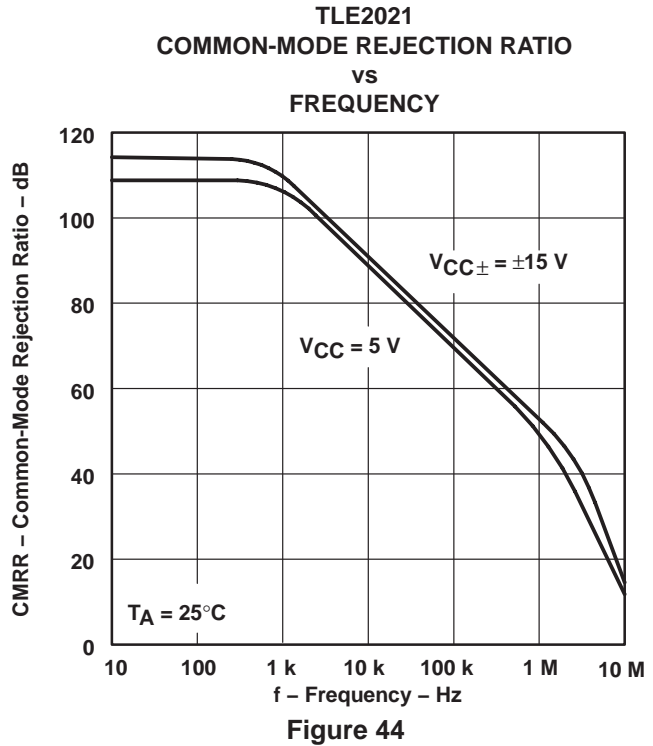
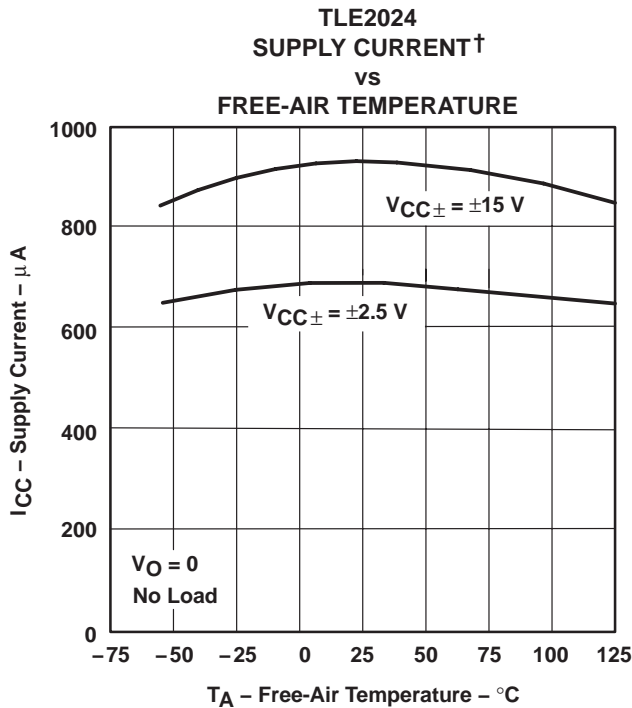

† Data at high and low temperatures are applicable only within the rated operating free-air temperature ranges of the various devices.

TYPICAL CHARACTERISTICS

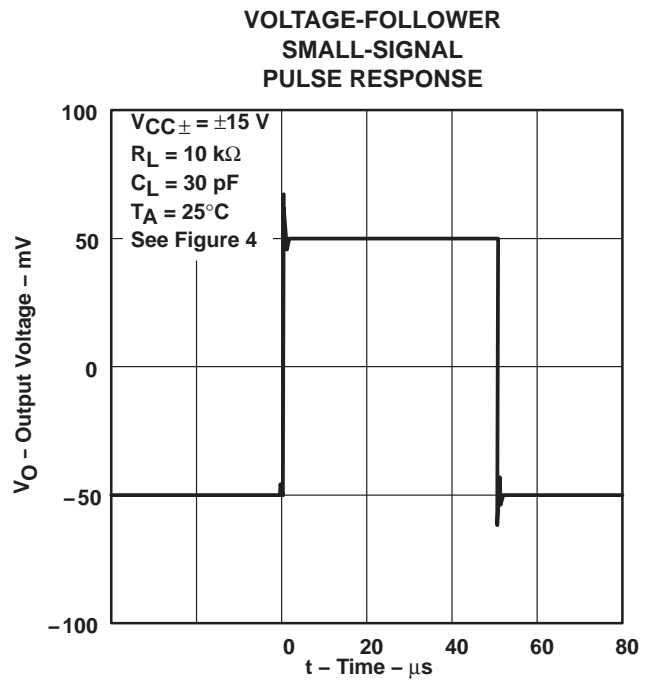
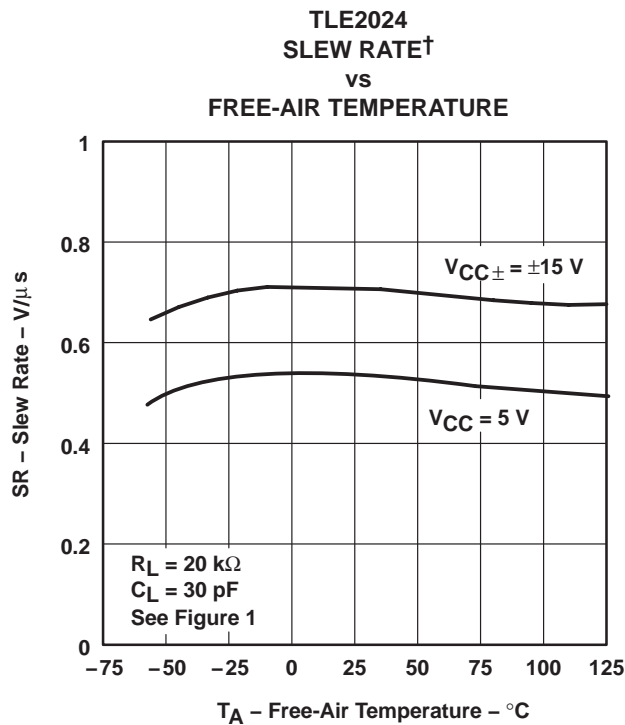
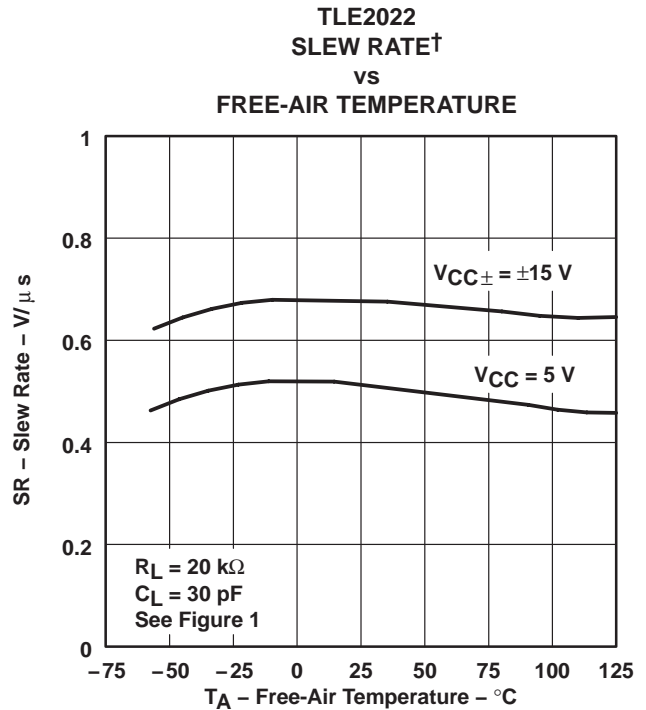
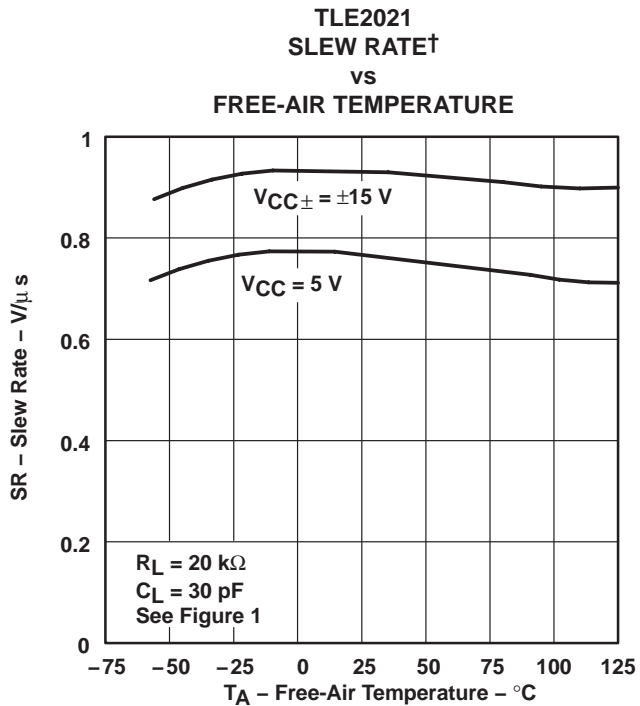

† Data at high and low temperatures are applicable only within the rated operating free-air temperature ranges of the various devices.

TLE202x-EP, TLE202xA-EP
EXCALIBUR HIGH-SPEED LOW-POWER PRECISION
OPERATIONAL AMPLIFIERS

SGLS235B– FEBRUARY 2004 – REVISED JUNE 2007

TYPICAL CHARACTERISTICS

**VOLTAGE-FOLLOWER
 SMALL-SIGNAL
 PULSE RESPONSE**

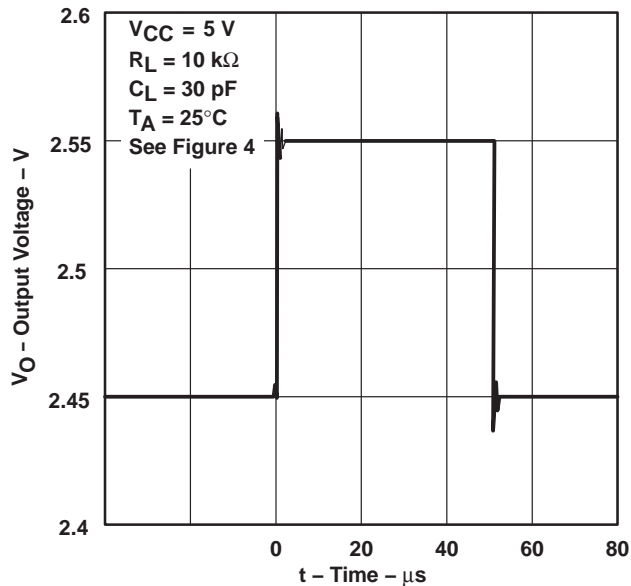

Figure 51

**TLE2021
 VOLTAGE-FOLLOWER LARGE-SIGNAL
 PULSE RESPONSE**

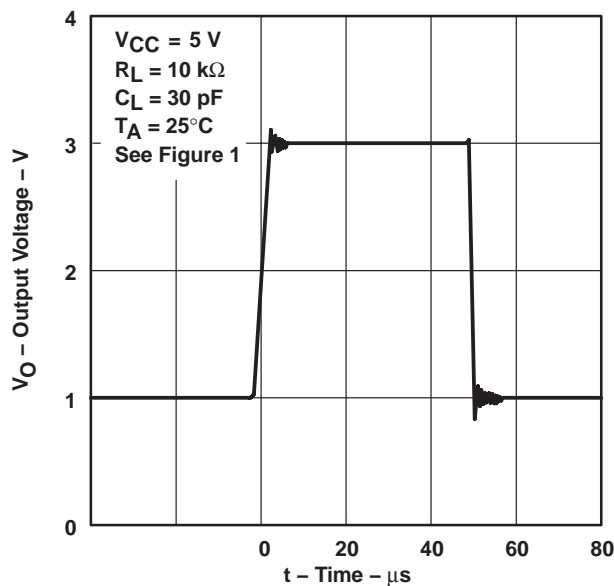

Figure 52

**TLE2022
 VOLTAGE-FOLLOWER LARGE-SIGNAL
 PULSE RESPONSE**

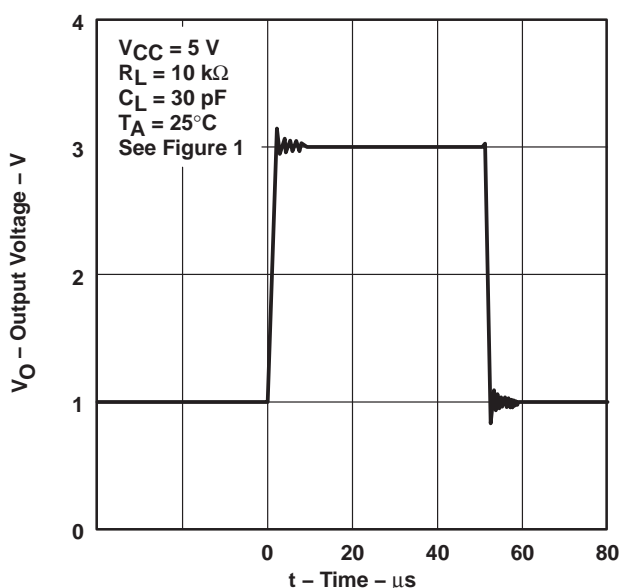

Figure 53

**TLE2024
 VOLTAGE-FOLLOWER LARGE-SCALE
 PULSE RESPONSE**

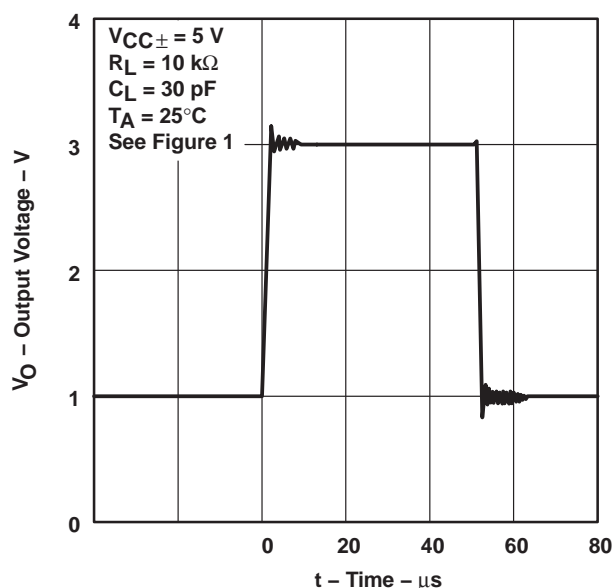

Figure 54



TYPICAL CHARACTERISTICS

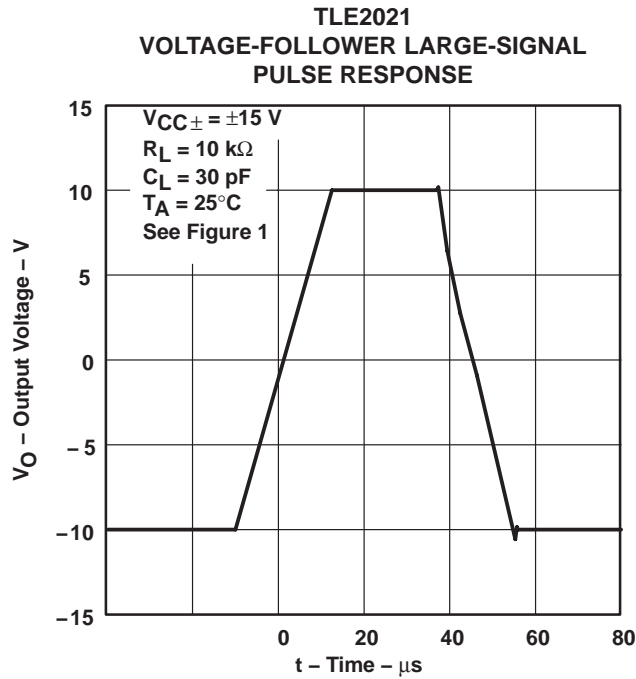

Figure 55

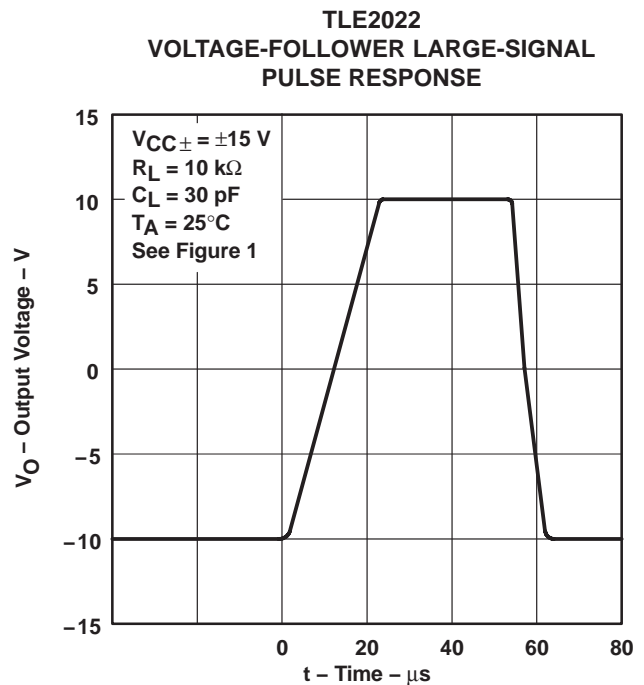

Figure 56

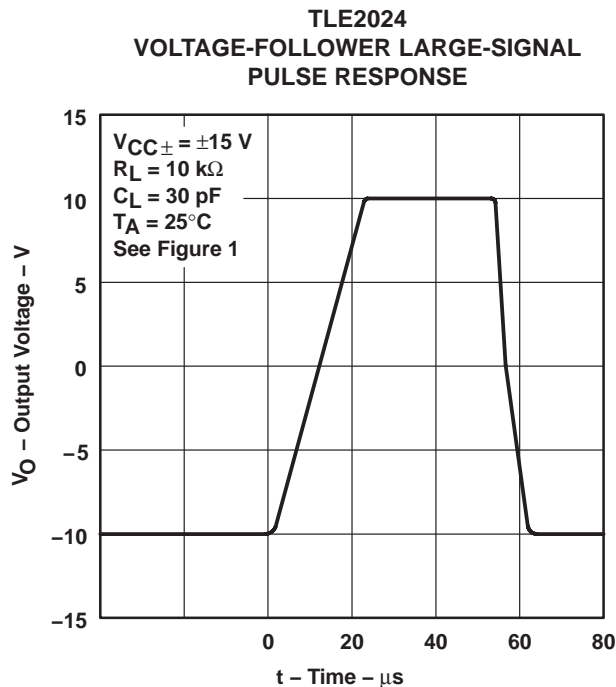

Figure 57

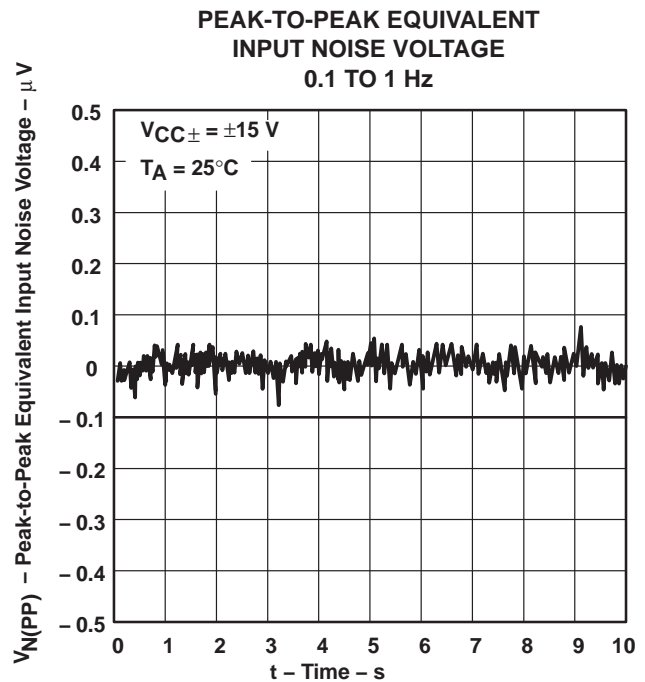

Figure 58

TLE202x-EP, TLE202xA-EP
EXCALIBUR HIGH-SPEED LOW-POWER PRECISION
OPERATIONAL AMPLIFIERS

SGLS235B– FEBRUARY 2004 – REVISED JUNE 2007

TYPICAL CHARACTERISTICS

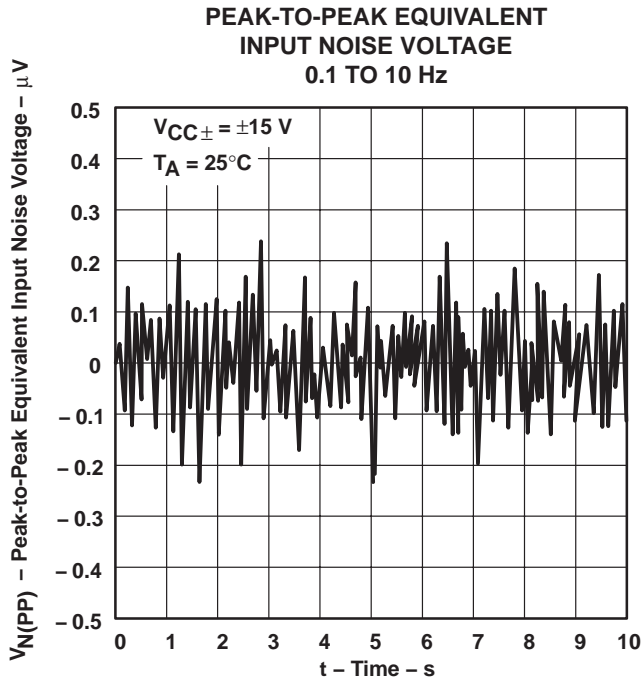

Figure 59

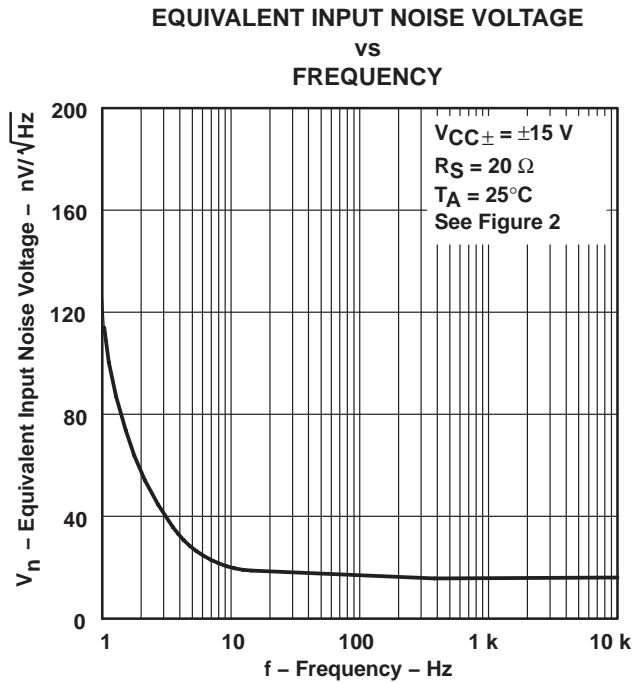

Figure 60

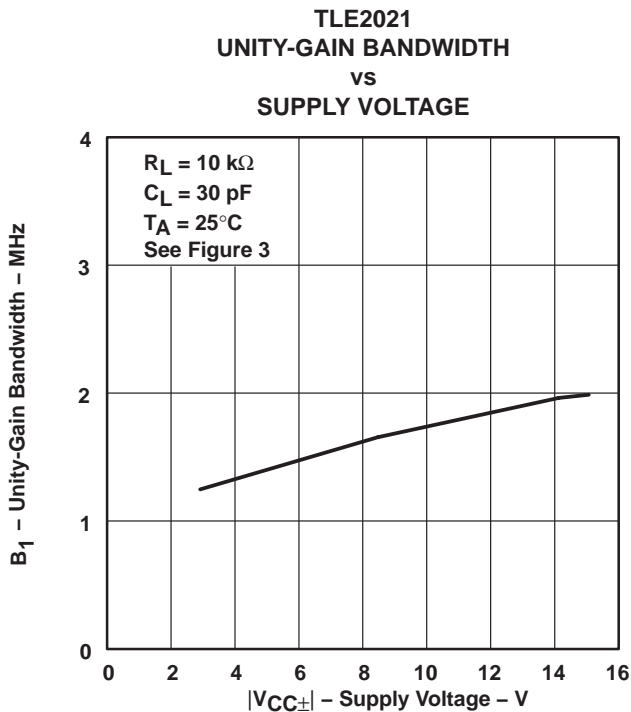

Figure 61

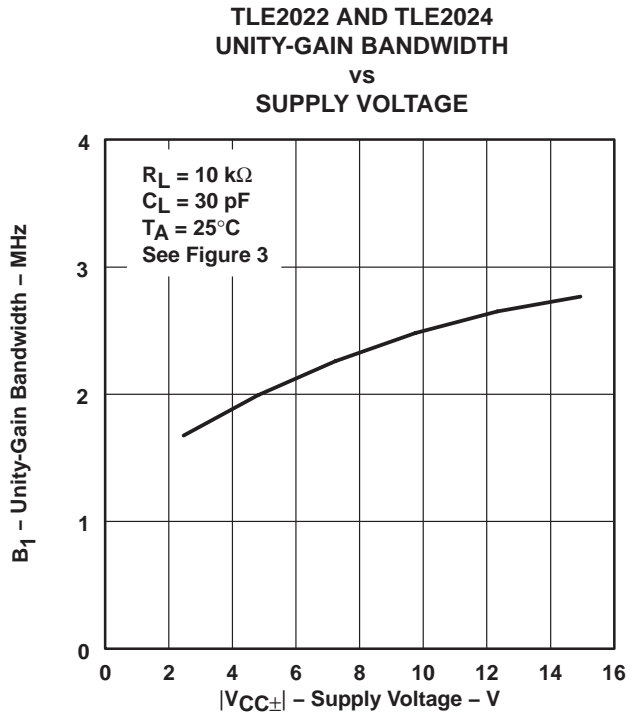

Figure 62



TYPICAL CHARACTERISTICS

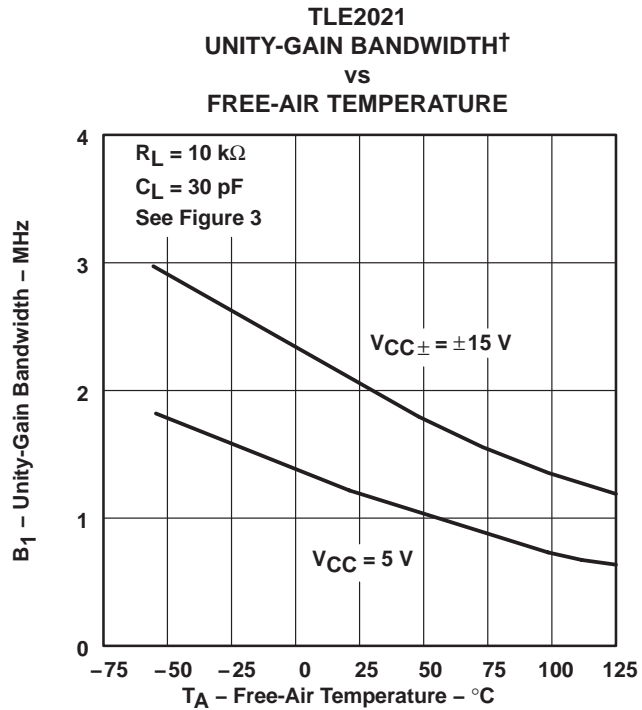

Figure 63

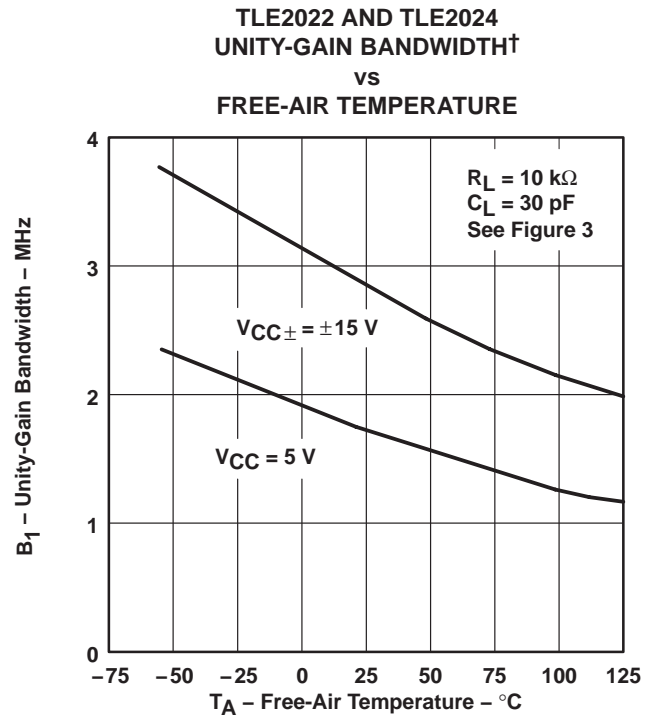

Figure 64

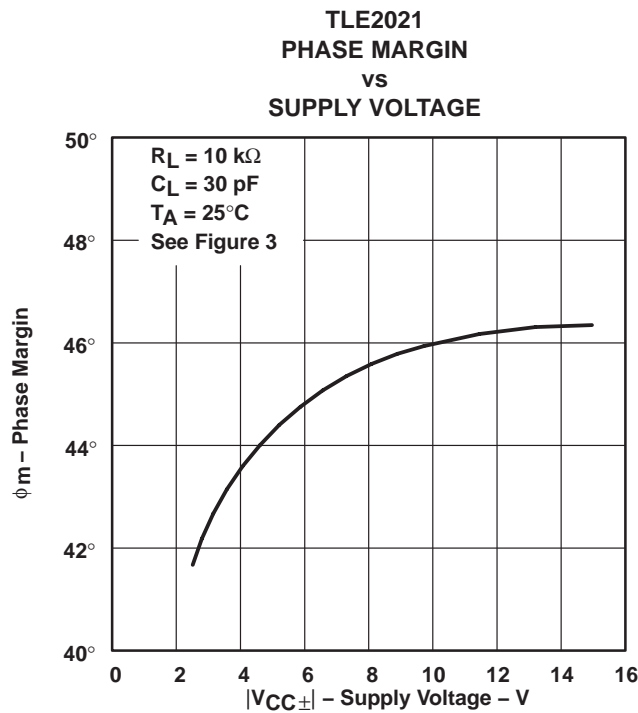

Figure 65

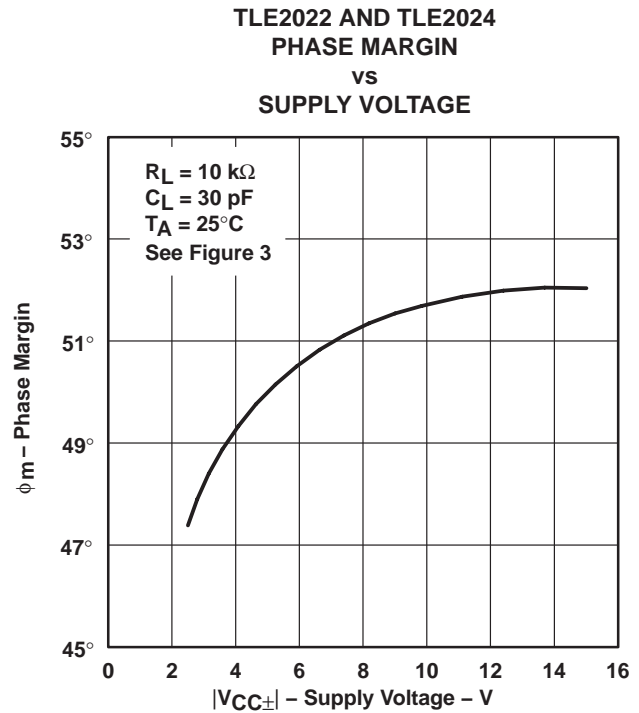

Figure 66

† Data at high and low temperatures are applicable only within the rated operating free-air temperature ranges of the various devices.

TLE202x-EP, TLE202xA-EP EXCALIBUR HIGH-SPEED LOW-POWER PRECISION OPERATIONAL AMPLIFIERS

SGLS235B– FEBRUARY 2004 – REVISED JUNE 2007

TYPICAL CHARACTERISTICS

**TLE2021
PHASE MARGIN
VS
LOAD CAPACITANCE**

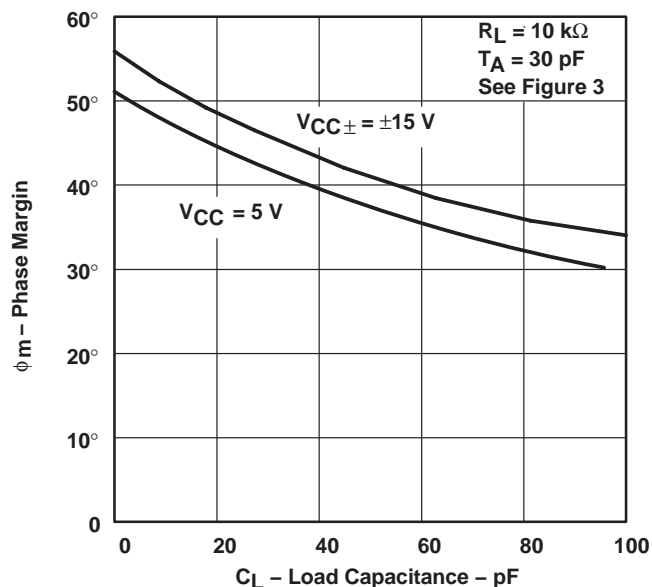

Figure 67

**TLE2022 AND TLE2024
PHASE MARGIN
VS
LOAD CAPACITANCE**

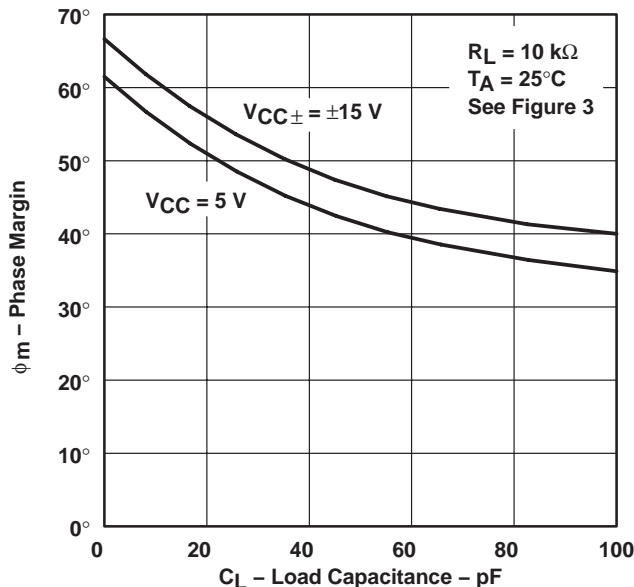

Figure 68

**TLE2021
PHASE MARGIN†
VS
FREE-AIR TEMPERATURE**

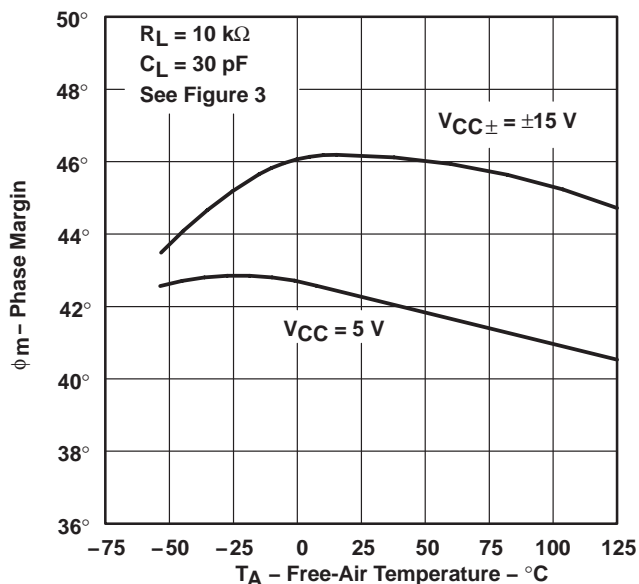

Figure 69

**TLE2022 AND TLE2024
PHASE MARGIN†
VS
FREE-AIR TEMPERATURE**

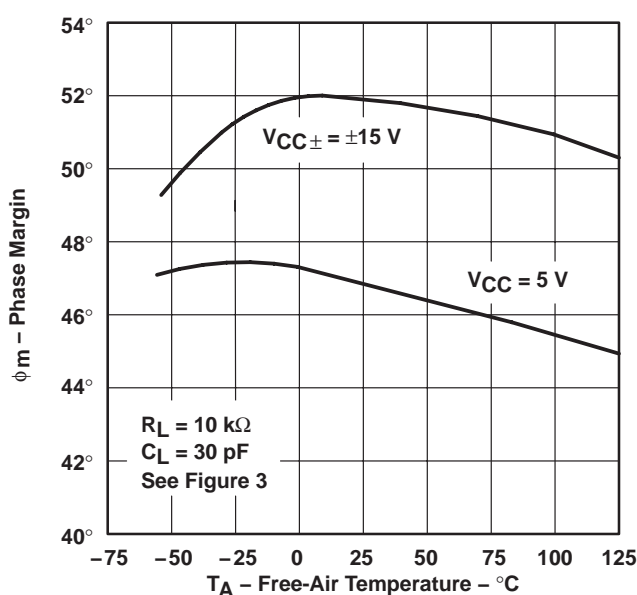

Figure 70

† Data at high and low temperatures are applicable only within the rated operating free-air temperature ranges of the various devices.

APPLICATION INFORMATION

voltage-follower applications

The TLE202x circuitry includes input-protection diodes to limit the voltage across the input transistors; however, no provision is made in the circuit to limit the current if these diodes are forward biased. This condition can occur when the device is operated in the voltage-follower configuration and driven with a fast, large-signal pulse. It is recommended that a feedback resistor be used to limit the current to a maximum of 1 mA to prevent degradation of the device. This feedback resistor forms a pole with the input capacitance of the device. For feedback resistor values greater than 10 k Ω , this pole degrades the amplifier phase margin. This problem can be alleviated by adding a capacitor (20 pF to 50 pF) in parallel with the feedback resistor (see Figure 71).

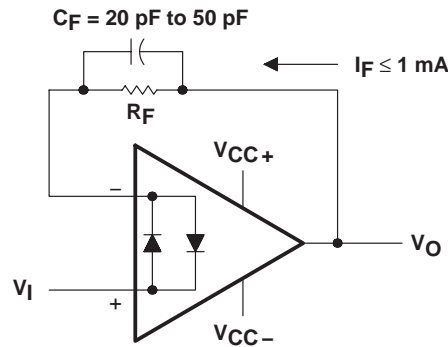

Figure 71. Voltage Follower

Input offset voltage nulling

The TLE202x series offers external null pins that further reduce the input offset voltage. The circuit in Figure 72 can be connected as shown if this feature is desired. When external nulling is not needed, the null pins may be left disconnected.

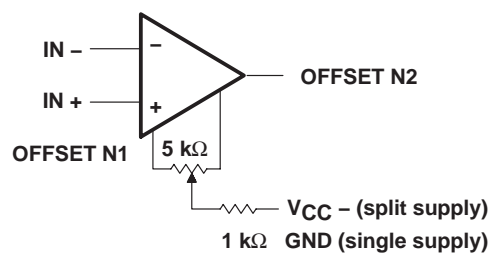

Figure 72. Input Offset Voltage Null Circuit

TLE202x-EP, TLE202xA-EP EXCALIBUR HIGH-SPEED LOW-POWER PRECISION OPERATIONAL AMPLIFIERS

SGLS235B– FEBRUARY 2004 – REVISED JUNE 2007

APPLICATION INFORMATION

macromodel information

Macromodel information provided was derived using Microsim *Parts*[™], the model generation software used with Microsim *PSpice*[™]. The Boyle macromodel (see Note 5) and subcircuit in Figure 73, Figure 74, and Figure 75 were generated using the TLE202x typical electrical and operating characteristics at 25°C. Using this information, output simulations of the following key parameters can be generated to a tolerance of 20% (in most cases):

- Maximum positive output voltage swing
- Maximum negative output voltage swing
- Slew rate
- Quiescent power dissipation
- Input bias current
- Open-loop voltage amplification
- Unity-gain frequency
- Common-mode rejection ratio
- Phase margin
- DC output resistance
- AC output resistance
- Short-circuit output current limit

NOTE 5: G. R. Boyle, B. M. Cohn, D. O. Pederson, and J. E. Solomon, "Macromodeling of Integrated Circuit Operational Amplifiers", *IEEE Journal of Solid-State Circuits*, SC-9, 353 (1974).

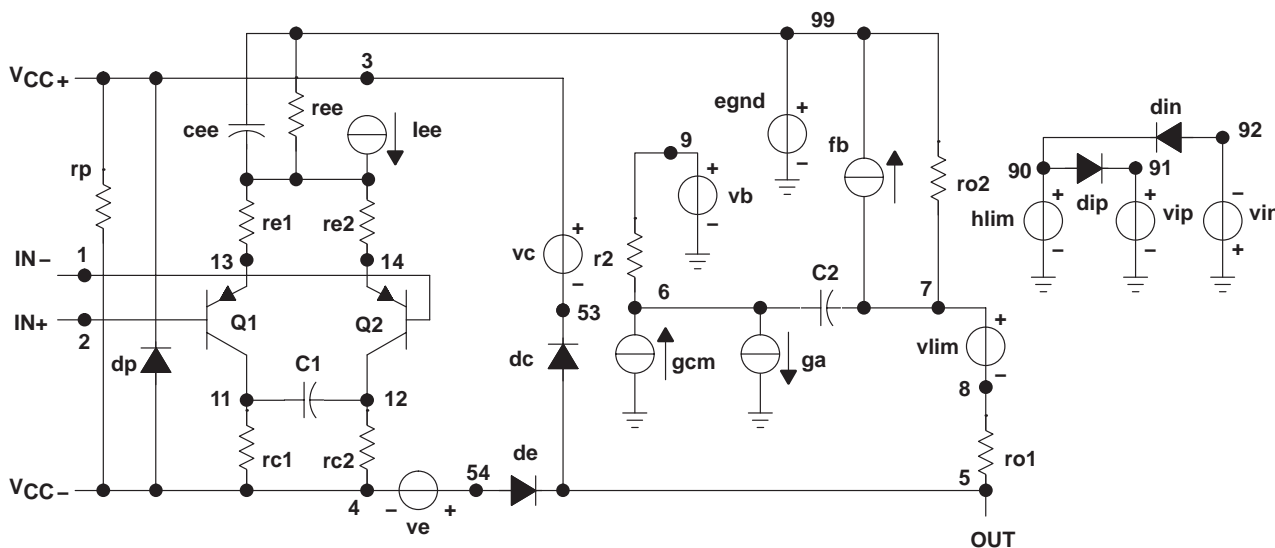

Figure 73. Boyle Subcircuit

PSpice and *Parts* are trademarks of MicroSim Corporation.

TLE202x-EP, TLE202xA-EP
EXCALIBUR HIGH-SPEED LOW-POWER PRECISION
OPERATIONAL AMPLIFIERS

SGLS235B– FEBRUARY 2004 – REVISED JUNE 2007

```
.SUBCKT TLE2021 1 2 3 4 5
*
c1 11 12 6.244E-12
c2 6 7 13.4E-12
c3 87 0 10.64E-9
cpsr 85 86 15.9E-9
dcm+ 81 82 dx
dcm- 83 81 dx
dc 5 53 dx
de 54 5 dx
dlp 90 91 dx
dln 92 90 dx
dp 4 3 dx
ecmr 84 99 (2 99) 1
egnd 99 0 poly(2) (3,0) (4,0) 0 .5 .5
epsr 85 0 poly(1) (3,4) -60E-6 2.0E-6
ense 89 2 poly(1) (88,0) 120E-6 1
fb 7 99 poly(6) vb vc ve vlp vln vpsr 0 547.3E6
+ -50E7 50E7 50E7 -50E7 547E6
ga 6 0 11 12 188.5E-6
gcm 0 6 10 99 335.2E-12
gpsr 85 86 (85,86) 100E-6
grc1 4 11 (4,11) 1.885E-4
grc2 4 12 (4,12) 1.885E-4
gre1 13 10 (13,10) 6.82E-4
gre2 14 10 (14,10) 6.82E-4
hlim 90 0 vlim 1k

hcmr 80 1 poly(2) vcm+ vcm- 0 1E2 1E2
irp 3 4 185E-6
iee 3 10 dc 15.67E-6
iio 2 0 2E-9
i1 88 0 1E-21
q1 11 89 13 qx
q2 12 80 14 qx
R2 6 9 100.0E3
rcm 84 81 1K
ree 10 99 14.76E6
rn1 87 0 2.55E8
rn2 87 88 11.67E3
ro1 8 5 62
ro2 7 99 63
vcm+ 82 99 13.3
vcm- 83 99 -14.6
vb 9 0 dc 0
vc 3 53 dc 1.300
ve 54 4 dc 1.500
vlim 7 8 dc 0
vlp 91 0 dc 3.600
vln 0 92 dc 3.600
vpsr 0 86 dc 0
.model dx d(is=800.0E-18)
.model qx pnp(is=800.0E-18 bf=270)
.ends
```

Figure 74. Boyle Macromodel for the TLE2021

```
.SUBCKT TLE2022 1 2 3 4 5
*
c1 11 12 6.814E-12
c2 6 7 20.00E-12
dc 5 53 dx
de 54 5 dx
dlp 90 91 dx
dln 92 90 dx
dp 4 3 dx
egnd 99 0 poly(2) (3,0) (4,0) 0 .5 .5
fb 7 99 poly(5) vb vc ve vlp vln 0
+ 45.47E6 -50E6 50E6 50E6 -50E6
ga 6 0 11 12 377.9E-6
gcm 0 6 10 99 7.84E-10
iee 3 10 DC 18.07E-6
hlim 90 0 vlim 1k
q1 11 2 13 qx
q2 12 1 14 qx
r2 6 9 100.0E3

rc1 4 11 2.842E3
rc2 4 12 2.842E3
ge1 13 10 (10,13) 31.299E-3
ge2 14 10 (10,14) 31.299E-3
ree 10 99 11.07E6
ro1 8 5 250
ro2 7 99 250
rp 3 4 137.2E3
vb 9 0 dc 0
vc 3 53 dc 1.300
ve 54 4 dc 1.500
vlim 7 8 dc 0
vlp 91 0 dc 3
vln 0 92 dc 3
.model dx d(is=800.0E-18)
.model qx pnp(is=800.0E-18 bf=257.1)
.ends
```

Figure 75. Boyle Macromodel for the TLE2022



PACKAGING INFORMATION

Orderable Device	Status ⁽¹⁾	Package Type	Package Drawing	Pins	Package Qty	Eco Plan ⁽²⁾	Lead/Ball Finish	MSL Peak Temp ⁽³⁾
TLE2021AQDREP	ACTIVE	SOIC	D	8	2500	Green (RoHS & no Sb/Br)	CU NIPDAU	Level-1-260C-UNLIM
TLE2021QDREP	ACTIVE	SOIC	D	8	2500	Green (RoHS & no Sb/Br)	CU NIPDAU	Level-1-260C-UNLIM
TLE2022AQDREP	ACTIVE	SOIC	D	8	2500	Green (RoHS & no Sb/Br)	CU NIPDAU	Level-1-260C-UNLIM
TLE2022QDREP	ACTIVE	SOIC	D	8	2500	Green (RoHS & no Sb/Br)	CU NIPDAU	Level-1-260C-UNLIM
TLE2024AQDWREP	ACTIVE	SOIC	DW	16	2000	Green (RoHS & no Sb/Br)	CU NIPDAU	Level-1-260C-UNLIM
TLE2024QDWREP	ACTIVE	SOIC	DW	16	2000	Green (RoHS & no Sb/Br)	CU NIPDAU	Level-1-260C-UNLIM
V62/04755-01XE	ACTIVE	SOIC	D	8	2500	Green (RoHS & no Sb/Br)	CU NIPDAU	Level-1-260C-UNLIM
V62/04755-02XE	ACTIVE	SOIC	D	8	2500	Green (RoHS & no Sb/Br)	CU NIPDAU	Level-1-260C-UNLIM
V62/04755-03XE	ACTIVE	SOIC	D	8	2500	Green (RoHS & no Sb/Br)	CU NIPDAU	Level-1-260C-UNLIM
V62/04755-04XE	ACTIVE	SOIC	D	8	2500	Green (RoHS & no Sb/Br)	CU NIPDAU	Level-1-260C-UNLIM
V62/04755-05YE	ACTIVE	SOIC	DW	16	2000	Green (RoHS & no Sb/Br)	CU NIPDAU	Level-1-260C-UNLIM
V62/04755-06YE	ACTIVE	SOIC	DW	16	2000	Green (RoHS & no Sb/Br)	CU NIPDAU	Level-1-260C-UNLIM

⁽¹⁾ The marketing status values are defined as follows:

ACTIVE: Product device recommended for new designs.

LIFEBUY: TI has announced that the device will be discontinued, and a lifetime-buy period is in effect.

NRND: Not recommended for new designs. Device is in production to support existing customers, but TI does not recommend using this part in a new design.

PREVIEW: Device has been announced but is not in production. Samples may or may not be available.

OBSOLETE: TI has discontinued the production of the device.

⁽²⁾ Eco Plan - The planned eco-friendly classification: Pb-Free (RoHS), Pb-Free (RoHS Exempt), or Green (RoHS & no Sb/Br) - please check <http://www.ti.com/productcontent> for the latest availability information and additional product content details.

TBD: The Pb-Free/Green conversion plan has not been defined.

Pb-Free (RoHS): TI's terms "Lead-Free" or "Pb-Free" mean semiconductor products that are compatible with the current RoHS requirements for all 6 substances, including the requirement that lead not exceed 0.1% by weight in homogeneous materials. Where designed to be soldered at high temperatures, TI Pb-Free products are suitable for use in specified lead-free processes.

Pb-Free (RoHS Exempt): This component has a RoHS exemption for either 1) lead-based flip-chip solder bumps used between the die and package, or 2) lead-based die adhesive used between the die and leadframe. The component is otherwise considered Pb-Free (RoHS compatible) as defined above.

Green (RoHS & no Sb/Br): TI defines "Green" to mean Pb-Free (RoHS compatible), and free of Bromine (Br) and Antimony (Sb) based flame retardants (Br or Sb do not exceed 0.1% by weight in homogeneous material)

⁽³⁾ MSL, Peak Temp. -- The Moisture Sensitivity Level rating according to the JEDEC industry standard classifications, and peak solder temperature.

Important Information and Disclaimer: The information provided on this page represents TI's knowledge and belief as of the date that it is provided. TI bases its knowledge and belief on information provided by third parties, and makes no representation or warranty as to the accuracy of such information. Efforts are underway to better integrate information from third parties. TI has taken and continues to take reasonable steps to provide representative and accurate information but may not have conducted destructive testing or chemical analysis on incoming materials and chemicals. TI and TI suppliers consider certain information to be proprietary, and thus CAS numbers and other limited information may not be available for release.

In no event shall TI's liability arising out of such information exceed the total purchase price of the TI part(s) at issue in this document sold by TI to Customer on an annual basis.

OTHER QUALIFIED VERSIONS OF TLE2021-EP, TLE2021A-EP, TLE2022-EP, TLE2022A-EP, TLE2024-EP, TLE2024A-EP :

- Catalog: [TLE2021](#), [TLE2021A](#), [TLE2022](#), [TLE2022A](#), [TLE2024](#), [TLE2024A](#)
- Automotive: [TLE2021-Q1](#), [TLE2021A-Q1](#), [TLE2022-Q1](#), [TLE2022A-Q1](#), [TLE2024-Q1](#), [TLE2024A-Q1](#)
- Military: [TLE2021M](#), [TLE2021AM](#), [TLE2022M](#), [TLE2022AM](#), [TLE2024M](#), [TLE2024AM](#)

NOTE: Qualified Version Definitions:

- Catalog - TI's standard catalog product
- Automotive - Q100 devices qualified for high-reliability automotive applications targeting zero defects
- Military - QML certified for Military and Defense Applications

TAPE AND REEL INFORMATION



QUADRANT ASSIGNMENTS FOR PIN 1 ORIENTATION IN TAPE



*All dimensions are nominal

Device	Package Type	Package Drawing	Pins	SPQ	Reel Diameter (mm)	Reel Width W1 (mm)	A0 (mm)	B0 (mm)	K0 (mm)	P1 (mm)	W (mm)	Pin1 Quadrant
TLE2021AQDREP	SOIC	D	8	2500	330.0	12.4	6.4	5.2	2.1	8.0	12.0	Q1
TLE2021QDREP	SOIC	D	8	2500	330.0	12.4	6.4	5.2	2.1	8.0	12.0	Q1
TLE2022AQDREP	SOIC	D	8	2500	330.0	12.4	6.4	5.2	2.1	8.0	12.0	Q1
TLE2022QDREP	SOIC	D	8	2500	330.0	12.4	6.4	5.2	2.1	8.0	12.0	Q1
TLE2024AQDWREP	SOIC	DW	16	2000	330.0	16.4	10.75	10.7	2.7	12.0	16.0	Q1
TLE2024QDWREP	SOIC	DW	16	2000	330.0	16.4	10.75	10.7	2.7	12.0	16.0	Q1

TAPE AND REEL BOX DIMENSIONS



*All dimensions are nominal

Device	Package Type	Package Drawing	Pins	SPQ	Length (mm)	Width (mm)	Height (mm)
TLE2021AQDREP	SOIC	D	8	2500	346.0	346.0	29.0
TLE2021QDREP	SOIC	D	8	2500	346.0	346.0	29.0
TLE2022AQDREP	SOIC	D	8	2500	346.0	346.0	29.0
TLE2022QDREP	SOIC	D	8	2500	346.0	346.0	29.0
TLE2024AQDWREP	SOIC	DW	16	2000	346.0	346.0	33.0
TLE2024QDWREP	SOIC	DW	16	2000	346.0	346.0	33.0

D (R-PDSO-G8)

PLASTIC SMALL-OUTLINE PACKAGE

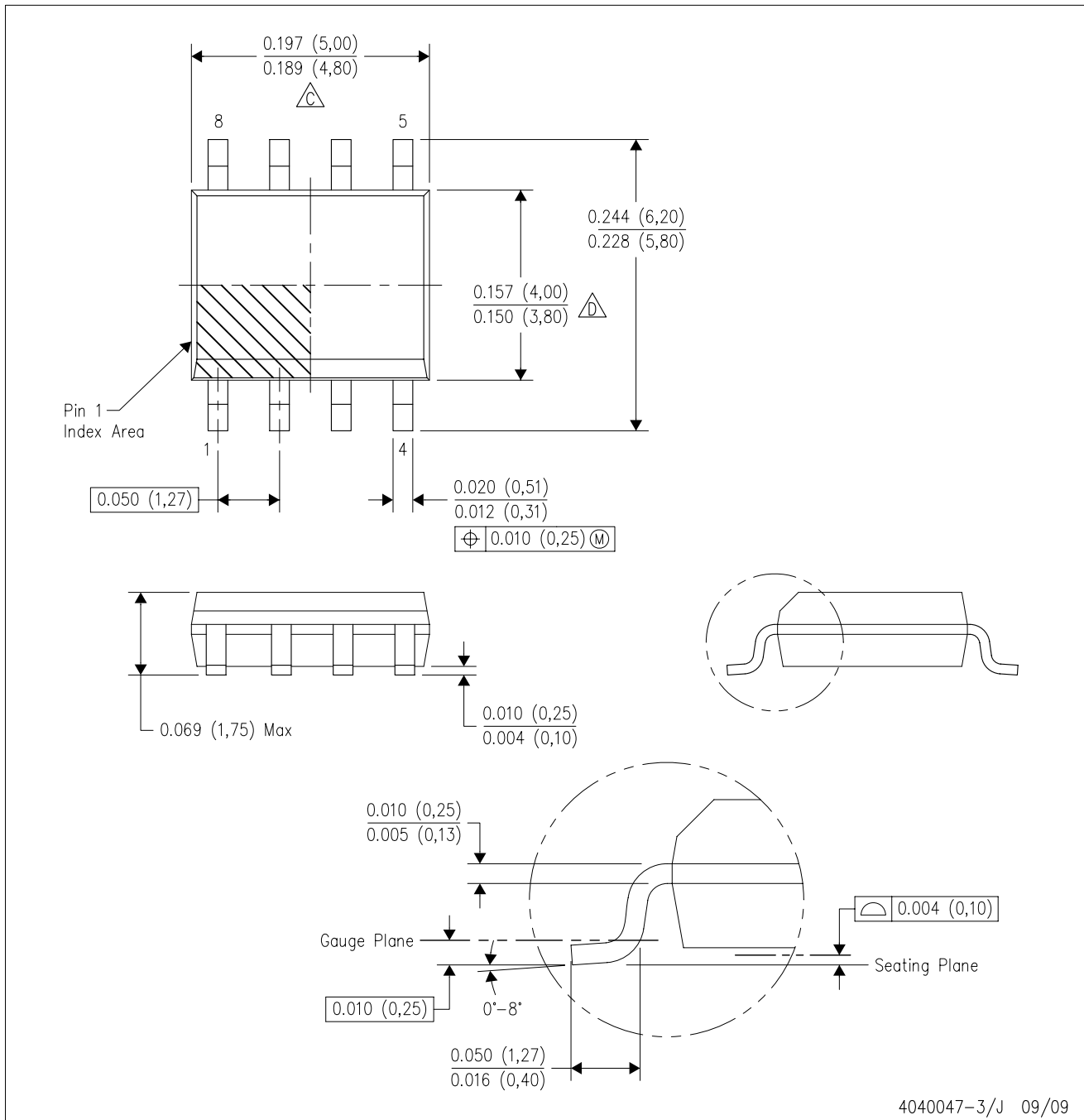

- NOTES:
- A. All linear dimensions are in inches (millimeters).
 - B. This drawing is subject to change without notice.
 - C. Body length does not include mold flash, protrusions, or gate burrs. Mold flash, protrusions, or gate burrs shall not exceed .006 (0,15) per end.
 - D. Body width does not include interlead flash. Interlead flash shall not exceed .017 (0,43) per side.
 - E. Reference JEDEC MS-012 variation AA.

DW (R-PDSO-G16)

PLASTIC SMALL-OUTLINE PACKAGE

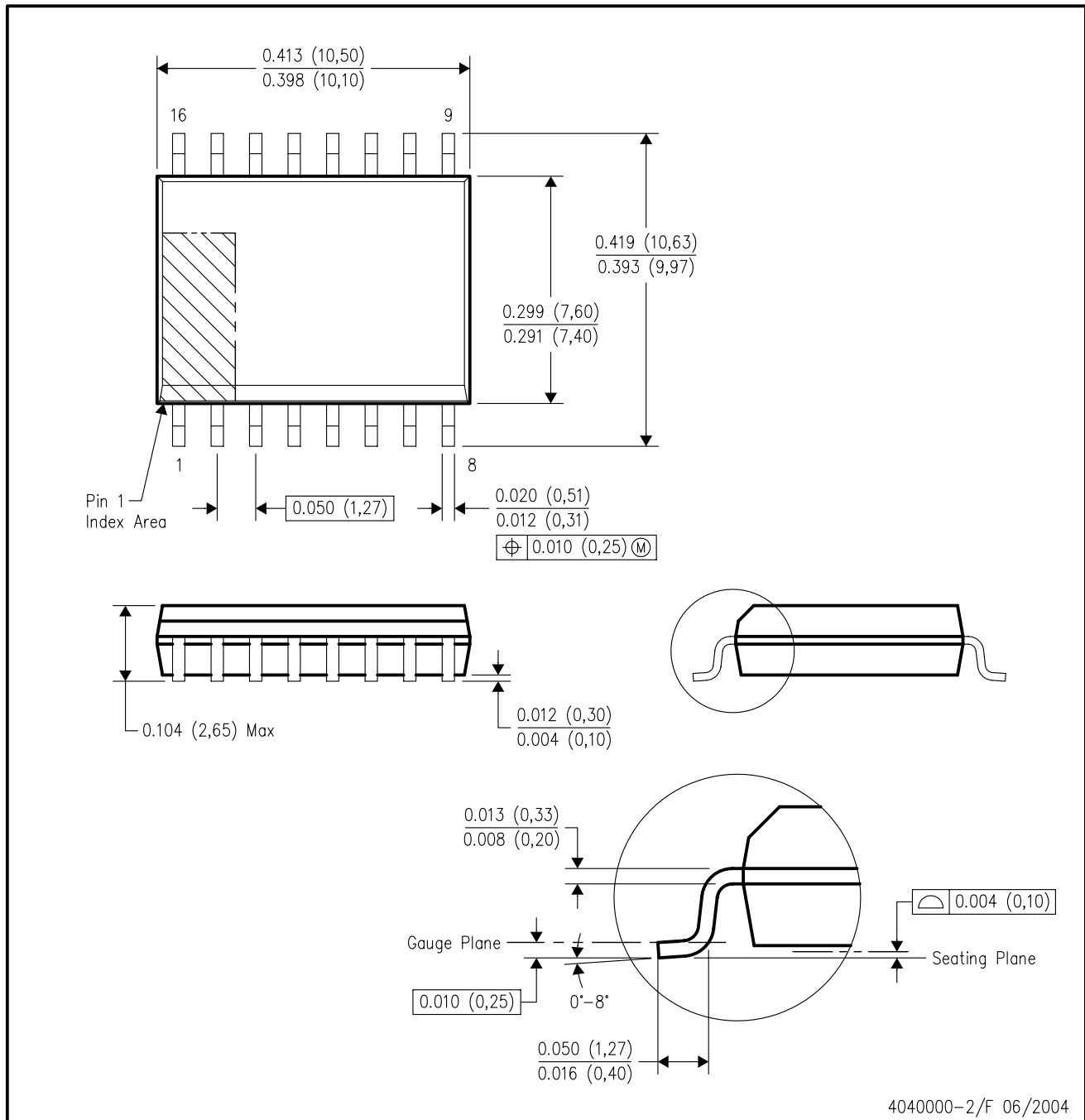

4040000-2/F 06/2004

- NOTES:
- A. All linear dimensions are in inches (millimeters).
 - B. This drawing is subject to change without notice.
 - C. Body dimensions do not include mold flash or protrusion not to exceed 0.006 (0,15).
 - D. Falls within JEDEC MS-013 variation AA.

IMPORTANT NOTICE

Texas Instruments Incorporated and its subsidiaries (TI) reserve the right to make corrections, modifications, enhancements, improvements, and other changes to its products and services at any time and to discontinue any product or service without notice. Customers should obtain the latest relevant information before placing orders and should verify that such information is current and complete. All products are sold subject to TI's terms and conditions of sale supplied at the time of order acknowledgment.

TI warrants performance of its hardware products to the specifications applicable at the time of sale in accordance with TI's standard warranty. Testing and other quality control techniques are used to the extent TI deems necessary to support this warranty. Except where mandated by government requirements, testing of all parameters of each product is not necessarily performed.

TI assumes no liability for applications assistance or customer product design. Customers are responsible for their products and applications using TI components. To minimize the risks associated with customer products and applications, customers should provide adequate design and operating safeguards.

TI does not warrant or represent that any license, either express or implied, is granted under any TI patent right, copyright, mask work right, or other TI intellectual property right relating to any combination, machine, or process in which TI products or services are used. Information published by TI regarding third-party products or services does not constitute a license from TI to use such products or services or a warranty or endorsement thereof. Use of such information may require a license from a third party under the patents or other intellectual property of the third party, or a license from TI under the patents or other intellectual property of TI.

Reproduction of TI information in TI data books or data sheets is permissible only if reproduction is without alteration and is accompanied by all associated warranties, conditions, limitations, and notices. Reproduction of this information with alteration is an unfair and deceptive business practice. TI is not responsible or liable for such altered documentation. Information of third parties may be subject to additional restrictions.

Resale of TI products or services with statements different from or beyond the parameters stated by TI for that product or service voids all express and any implied warranties for the associated TI product or service and is an unfair and deceptive business practice. TI is not responsible or liable for any such statements.

TI products are not authorized for use in safety-critical applications (such as life support) where a failure of the TI product would reasonably be expected to cause severe personal injury or death, unless officers of the parties have executed an agreement specifically governing such use. Buyers represent that they have all necessary expertise in the safety and regulatory ramifications of their applications, and acknowledge and agree that they are solely responsible for all legal, regulatory and safety-related requirements concerning their products and any use of TI products in such safety-critical applications, notwithstanding any applications-related information or support that may be provided by TI. Further, Buyers must fully indemnify TI and its representatives against any damages arising out of the use of TI products in such safety-critical applications.

TI products are neither designed nor intended for use in military/aerospace applications or environments unless the TI products are specifically designated by TI as military-grade or "enhanced plastic." Only products designated by TI as military-grade meet military specifications. Buyers acknowledge and agree that any such use of TI products which TI has not designated as military-grade is solely at the Buyer's risk, and that they are solely responsible for compliance with all legal and regulatory requirements in connection with such use.

TI products are neither designed nor intended for use in automotive applications or environments unless the specific TI products are designated by TI as compliant with ISO/TS 16949 requirements. Buyers acknowledge and agree that, if they use any non-designated products in automotive applications, TI will not be responsible for any failure to meet such requirements.

Following are URLs where you can obtain information on other Texas Instruments products and application solutions:

Products

Amplifiers	amplifier.ti.com
Data Converters	dataconverter.ti.com
DLP® Products	www.dlp.com
DSP	dsp.ti.com
Clocks and Timers	www.ti.com/clocks
Interface	interface.ti.com
Logic	logic.ti.com
Power Mgmt	power.ti.com
Microcontrollers	microcontroller.ti.com
RFID	www.ti-rfid.com
RF/IF and ZigBee® Solutions	www.ti.com/lprf

Applications

Audio	www.ti.com/audio
Automotive	www.ti.com/automotive
Broadband	www.ti.com/broadband
Digital Control	www.ti.com/digitalcontrol
Medical	www.ti.com/medical
Military	www.ti.com/military
Optical Networking	www.ti.com/opticalnetwork
Security	www.ti.com/security
Telephony	www.ti.com/telephony
Video & Imaging	www.ti.com/video
Wireless	www.ti.com/wireless

Mailing Address: Texas Instruments, Post Office Box 655303, Dallas, Texas 75265
Copyright © 2009, Texas Instruments Incorporated