

General Description of Light Emitting Diodes

■ Handling Precautions

This product is sensitive to static electricity and demands a lot of attention. Please take all possible measures for static electricity and surge solution.

■ Lead Forming Method

Avoid forming a lead pin with the lead pin base as a fulcrum: be sure to hold a lead pin firmly when forming. Lead pins should be formed before soldering.

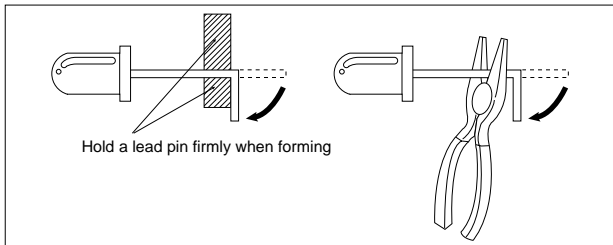

■ Installation

(1) Installation on a PWB

When mounting an LED lamp on a PWB, do not apply physical stress to the lead pins.

- (Notes)
- The lead pin pitch should match the PWB pin-hole pitch: do not broaden out or narrow down the lead pins.
 - When positioning an LED lamp, basically employ an LED with tie-bar cut or use a spacer.

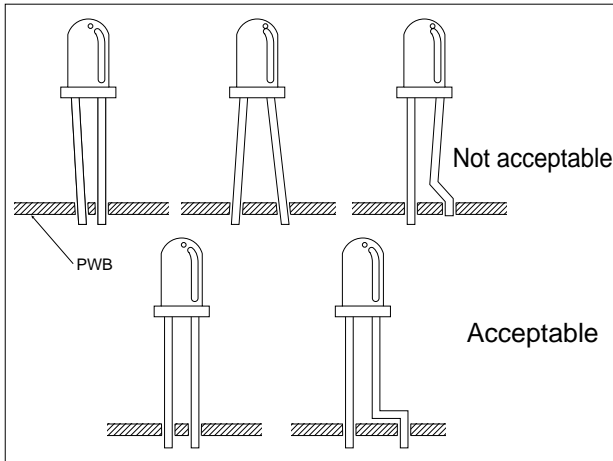

(2) When an LED lamp is mounted directly on a PWB

If the bottom face of an LED lamp is mounted directly on single-sided PWB (1.6mm t or more), the base of the lead pins may be subjected to have physical stress due to PWB warp, cutting or clinching of lead pins. Prior to use, be sure to check that no disconnection inside of the resin or damage to resin etc., is found.

When an LED lamp is mounted on a double-sided PWB, the heat during soldering affects the resin; therefore, keep the LED lamp more than 1.6mm afloat above the soldering position.

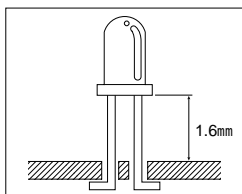

(3) Installation using a holder

During an LED lamp positioning, in case of using a holder, holder A should be designed to be smaller than the inside dimension of lead pins. Holder B should be designed to be larger than the outside dimension of lead pins.

- (Notes)
- Pay attention to the thermal expansion coefficient of the material used for the holder. Since the holder expands and contracts due to preheat and soldering heat, mechanical stress may be applied to the lead pins, resulting in disconnection.

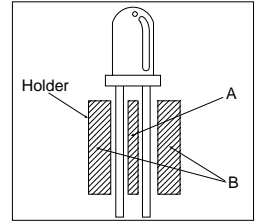

(4) Installation to the case

Do not fix part A with adhesives when fixed to the case as shown in the figure.

A hole of the case should be designed not to be smaller than the outside diameter of LED lamp resin.

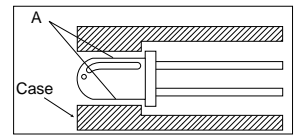

■ Soldering Conditions

Solder the lead pins under the following conditions. (1.6mm or more from the resin package)

Type of Soldering	Conditions
1. Manual soldering	295°C ± 5°C, within 3 seconds
2. Wave soldering	260°C ± 5°C, within 5 seconds
3. Reflow soldering	Preheating 70°C to 80°C, within 30 seconds Soldering 245°C ± 5°C, within 5 seconds

- (Notes)
- Avoid dipping resin into soldering bath.
 - Avoid applying stress to lead pins while they are heated. For example, when the LED lamp is moved with the heat applied to the lead pins during manual soldering or solder repair, disconnection may occur.

■ Cleaning

Conditions described below shall be observed in cleaning.

- (1) Solvent cleaning : Solvent temperature 45°C or less, for 3 min.
- (2) Ultrasonic cleaning : The affect on the device is different depending on the size of the cleaning bath, ultrasonic output, board size, and device mounting method. Test the cleaning method under actual conditions and check the abnormalities before actual use.
- (3) Recommended solvents are shown below.
Methyl alcohol, Ethyl alcohol, Isopropyl alcohol.
When other solvents are used, package resin may be penetrated by solvents. Please confirm under actual conditions before use.

General Description of Light Emitting Diodes

General LED Characteristics

(1) Absolute maximum ratings

Conditions which should never be exceeded to prevent destruction of the LED and which correlate with the operating temperature.

(2) Continuous forward current (I_F), peak forward current (I_{FM})

Current which causes the LED to emit light. Since the LED generates a certain amount of heat as current flows which affects the operating life, the current is limited by a forward current derating curve.

(3) Reverse voltage (V_R)

An LED is a diode designed for its light emitting characteristics. Unlike ordinary diodes, the reverse voltage cannot be controlled by changing the concentration of the PN junction. Therefore, if a 3 V or higher reverse bias is applied, the addition of a protective circuit is recommended.

(4) Power dissipation (P)

The internal power dissipation of the LED. The life of the LED lengthens if it is used at a dissipation (junction temperature) below a certain level (temperature).

(5) Operating temperature (T_{opr})

Refers to the temperature range including the heat generated by the device during operation of the LED. Operation under conditions where damage to the package material does not occur is recommended.

(6) Storage temperature (T_{stg})

Refers to the temperature range during non-operation of the LED. Since it is important for the LED package to pass light, it is not possible to change the content of the filler material to improve the temperature characteristics like for IC packages.

(7) Forward voltage (V_F)

The voltage between electrodes when forward current is applied to the LED. It differs according to the added impurities in the crystal material.

(8) Reverse current (I_R)

The current when reverse voltage is applied. It is sufficiently small compared to the forward current. It is recommended that a circuit which applies a reverse bias should be avoided.

(9) Luminous intensity (I_v)

Refers to the brightness measured at a distance of one foot from the light source. Common units are the μ cd and mcd. The magnitude of the numeric value and the apparent brightness do not necessarily correspond. In actuality, it is necessary to take into account the contrast, luminance and quantity of light.

(10) Peak emission wavelength (λ), spectrum radiation bandwidth ($\Delta\lambda$)

These characteristics differ according to the crystal material and added impurities.

(11) Directive characteristics, Half value of viewing angle

Represents the directivity dependency of the LED luminous intensity as a relative luminous intensity value. Generally, the luminous intensity is highest along the normal optical axis and decreases as the angle with respect to the optical axis increases. The angle at which the luminous intensity drops to 50% of the peak value is called the halfpower angle. It can be used as a guide showing the sharpness of the directivity.

Numbering System

New numbering system

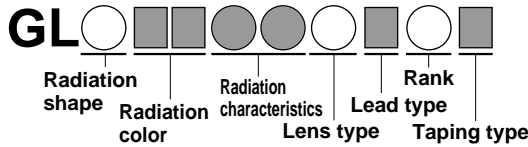
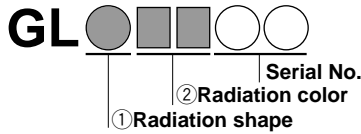

LED Large Lamp



① Radiation shape

- 2 — $\phi 2$
- 3 — $\phi 3$
- 4 — $\phi 4$
- 5/6 — $\phi 5$
- 7 — $\phi 7.5$
- 8 — Specific appearance
(Arch, Rectangle,
Square, Triangle)
- 0 — $\phi 10$

② Radiation color

■ Single color type

Series	Emitting color
B	Blue
KG, K	Green
EG, E, C*	Yellow-green
HY, H	Yellow
HS, S	Sunset orange
HD, D	Red
TR, T	Red(High-luminosity)
UR, U	Red(Super-luminosity)
PR, P	Red
ZG	Green(Super-luminosity)
ZE	Yellow-green(Super-luminosity)
ZV	Amber(Super-luminosity)
ZS	Sunset orange(Super-luminosity)
XS	Sunset orange(Super-luminosity)
ZJ	Orange(Super-luminosity)
ZR	Red(Super-luminosity)
JV	Amber(High-luminosity)
JS	Sunset orange(High-luminosity)
JJ	Orange(High-luminosity)
JR	Red(High-luminosity)
GT, GC	Green(Super-luminosity)
BT, BC	Blue(Super-luminosity)

*C: Inversion type of EG

■ Dichromatic type

Series	Emitting color
KS	GreenK+Sunset orangeS
EH	Yellow-greenE+YellowH
ED	Yellow-greenE+RedD
ET	Yellow-greenE+Red(High-luminosity)T
CU ^{*1}	Yellow-greenC+Red(Super-luminosity)U
EP	Yellow-greenE+RedP
HP	YellowH+RedP

*1 CU series : Anode common

*1 It is able to simplify the operation circuit due to Anode common connection.

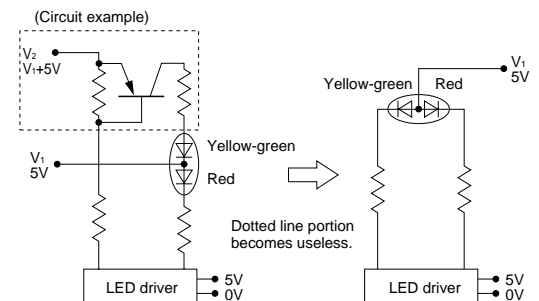

Note)Sharp can supply LED lamps with tie-bar. If necessary, please make contact to Sharp.

Ratings, electro-optical characteristics are shown on the page 96 to 104.

* LED is represented by the symbol below(JISC0301).

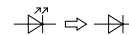

GL3□□44 series

ø3mm(T-1), Cylinder Type, Colorless Transparency, High-luminosity LED Lamps for Backlight/Indicator

Outline Dimensions

(Unit : mm)

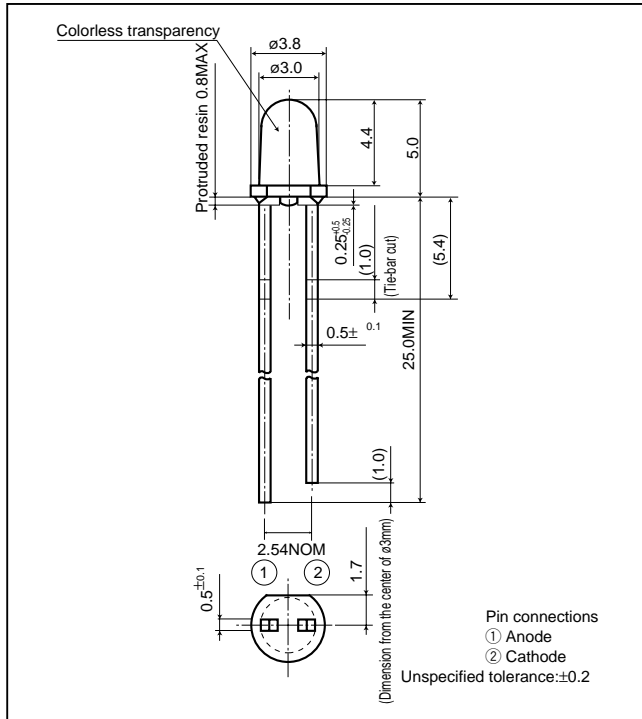

Directive Characteristics

(Ta=25°C)

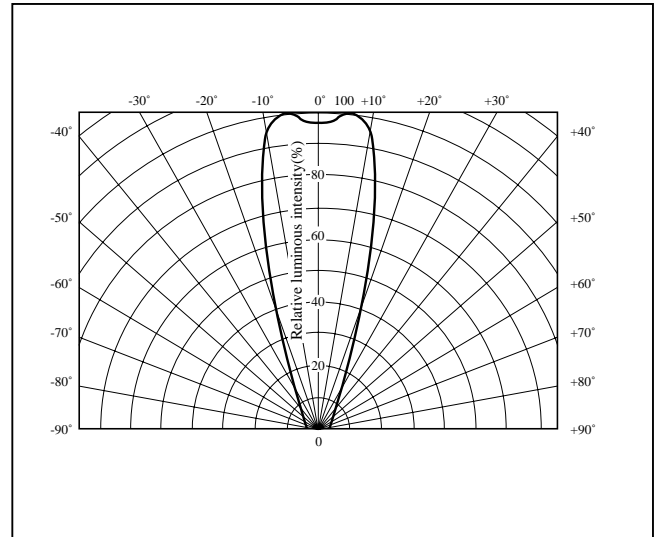

Absolute Maximum Ratings

(Ta=25°C)

Model No.	Emitting color	Material	Power dissipation P (mW)	Forward current IF (mA)	Peak forward current IFM (mA)	Derating factor (mA/°C)		Reverse voltage VR (V)	Operating temperature Topr (°C)	Storage temperature Tstg (°C)	Soldering temperature Tsol ^{*3} (°C)
						DC	Pulse				
GL3UR44	Red(Super-luminosity)	GaAlAs on GaAlAs	75	30	50*1	0.40	0.67	4	-25 to +85	-25 to +100	260
GL3TR44	Red(High-luminosity)	GaAlAs on GaAs	110	50	300*2	0.67	4.00	5	-25 to +85	-25 to +100	260

*1 Duty ratio=1/10, Pulse width=0.1ms

*2 Duty ratio=1/16, Pulse width<=1ms

*3 5s or less(At the position of 1.6mm or more from the bottom face of resin package)

Electro-optical Characteristics

(Ta=25°C)

Lens type	Model No.	Forward voltage VF(V)		Peak emission wavelength		Luminous intensity		Spectrum radiation bandwidth		Reverse current		Terminal capacitance		Page for characteristics diagrams
		TYP	MAX	λp(nm) TYP	IF (mA)	Iv(mcd) TYP	IF (mA)	Δλ(nm) TYP	IF (mA)	IR(μA) MAX	VR (V)	Ct(pF) TYP	(MHz)	
Colorless transparency	GL3UR44	1.85	2.5	660	20	250	20	20	20	100	3	25	1	99
	GL3TR44	1.75	2.2	660	20	110	20	20	20	10	4	30	1	100

Characteristics Diagrams

ZR series

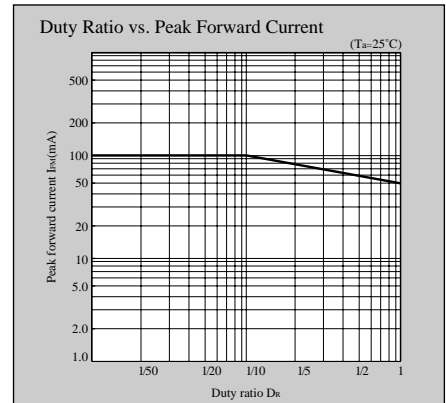
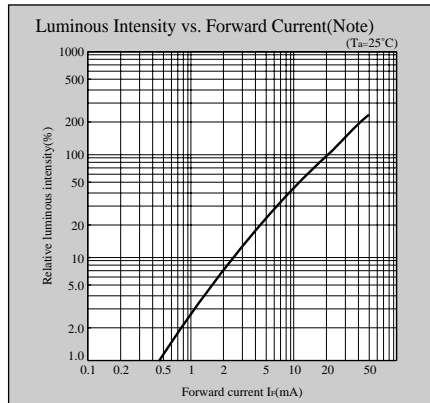
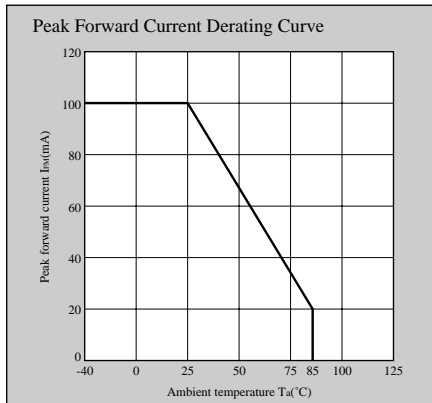
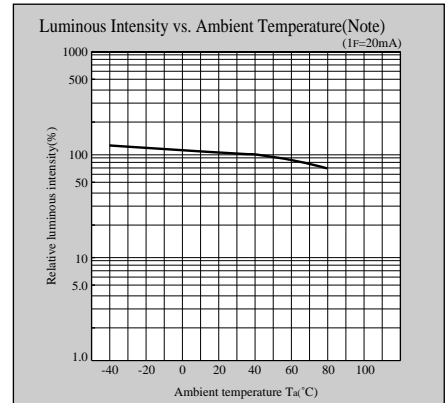
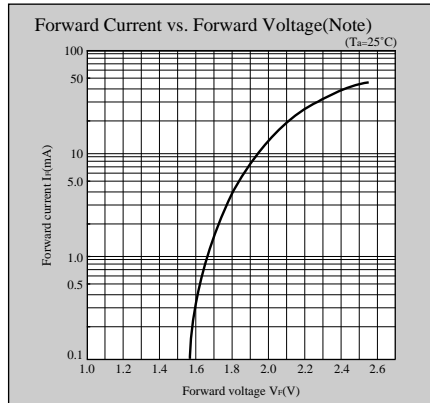
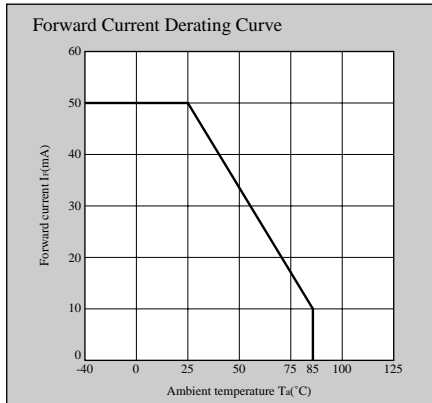

ZJ series

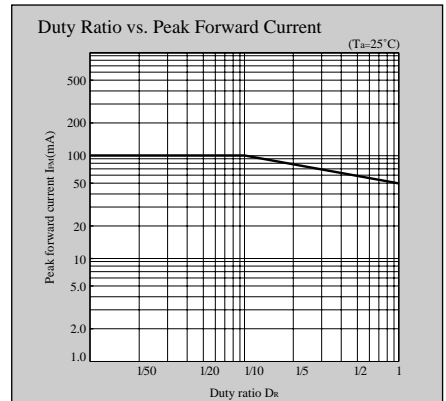
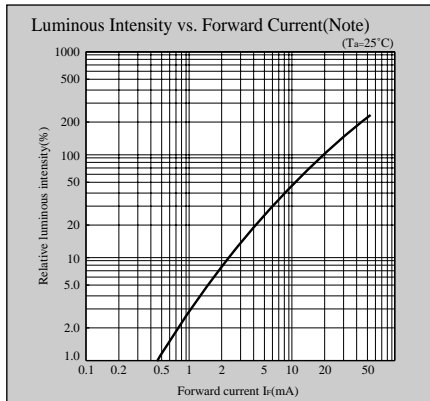
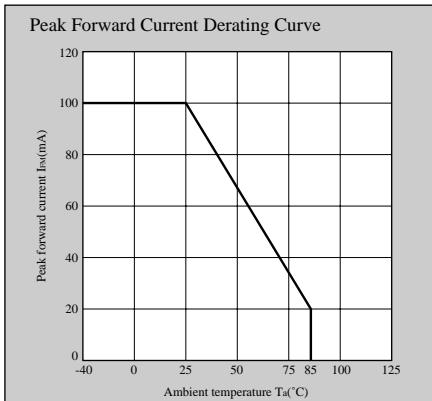
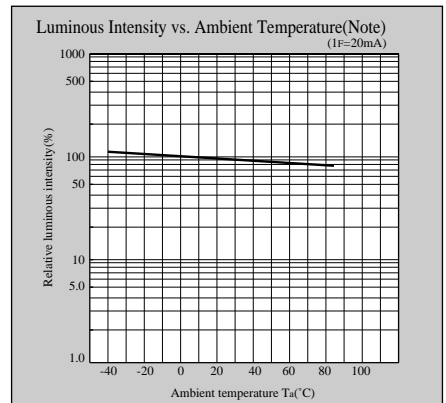
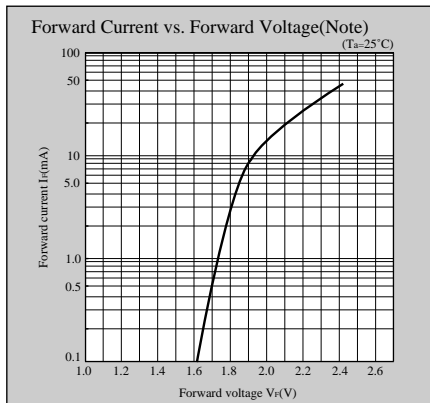
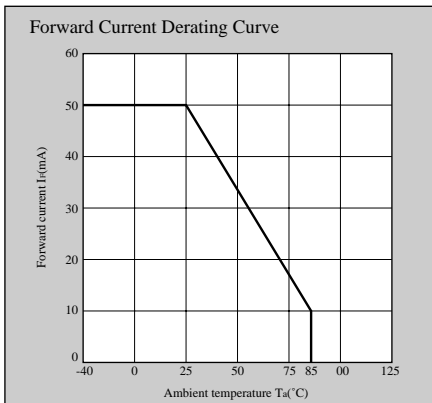

Note) Characteristics shown in diagrams are typical values. (not assurance value)

Characteristics Diagrams

ZS series

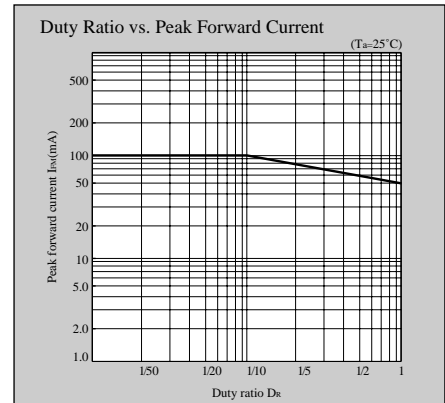
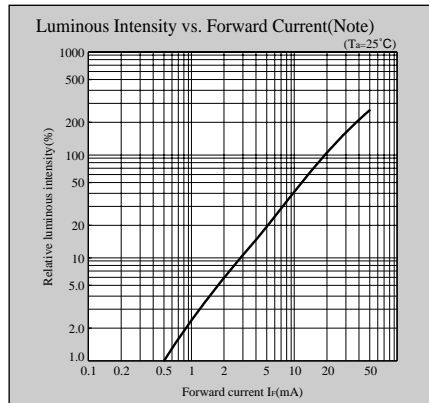
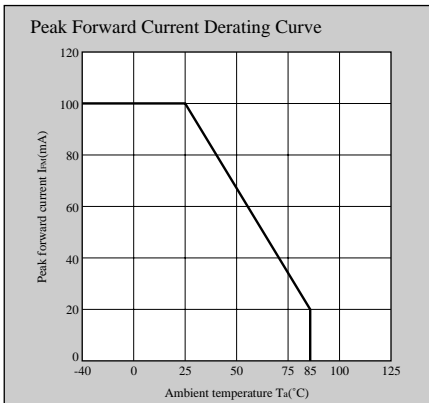
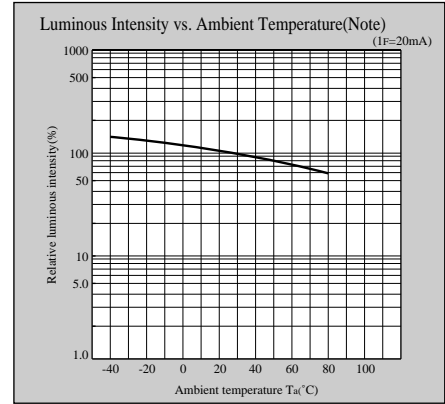
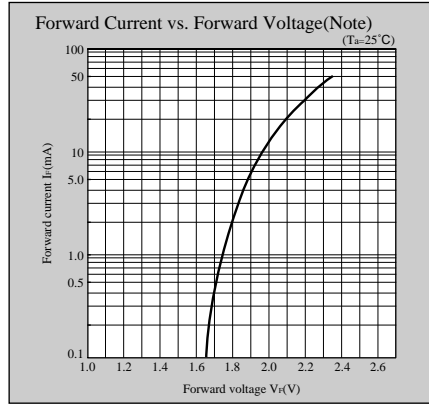
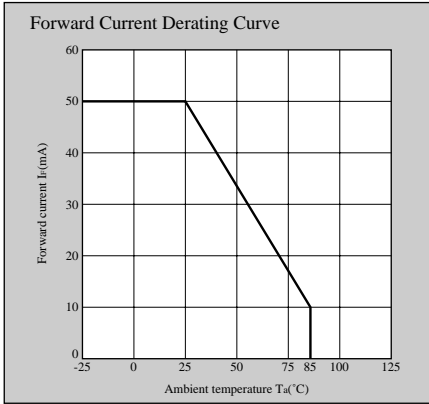

GL5XS022BOS

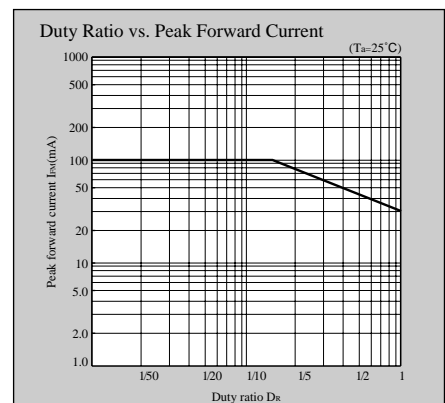
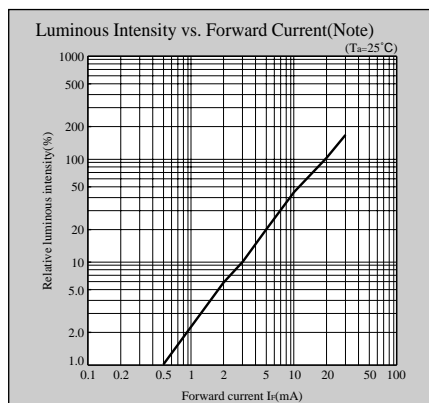
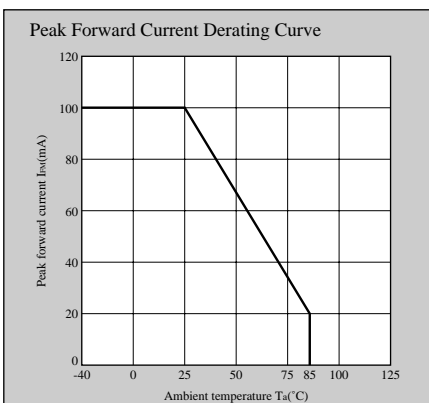
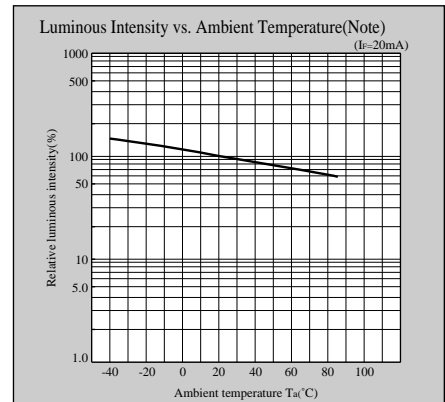
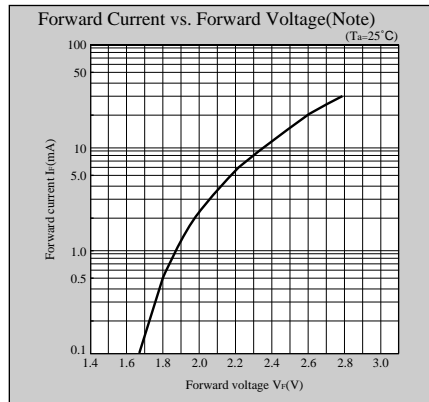
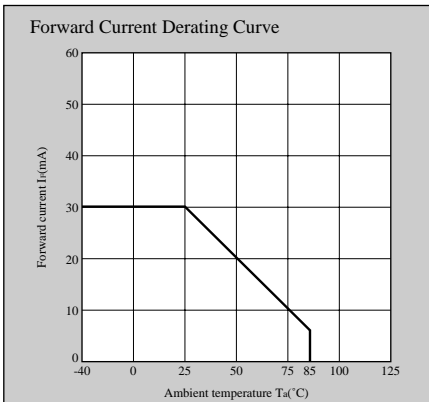

Note) Characteristics shown in diagrams are typical values. (not assurance value)

Notice In the absence of confirmation by device specification sheets, SHARP takes no responsibility for any defects that may occur in equipment using any SHARP devices shown in catalogs, data books, etc. Contact SHARP in order to obtain the latest device specification sheets before using any SHARP device.
Internet Internet address for Electronic Components Group <http://sharp-world.com/ecg>

Characteristics Diagrams

ZV series

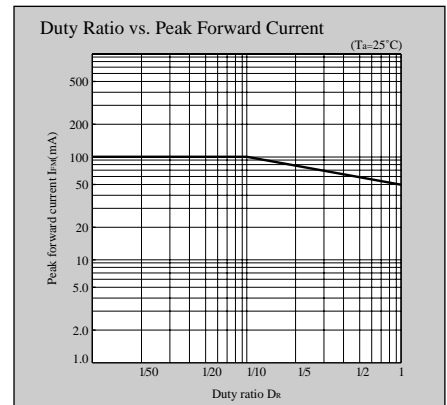
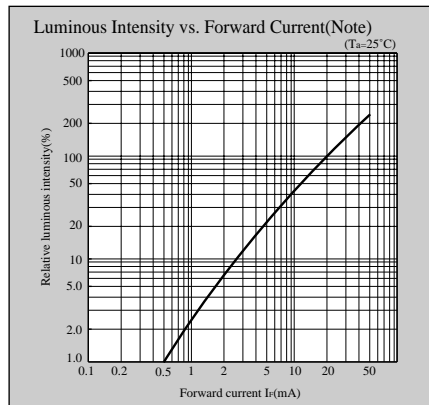
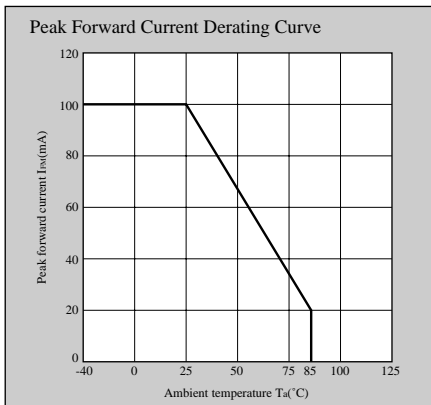
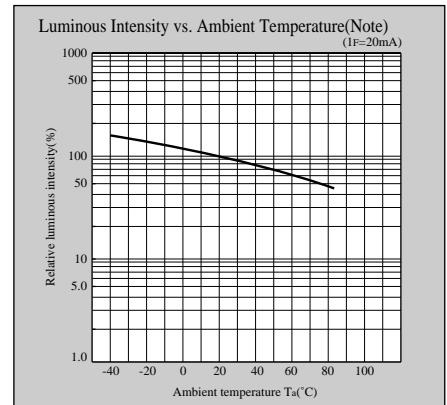
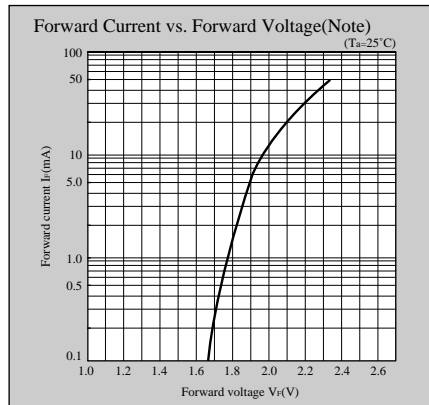
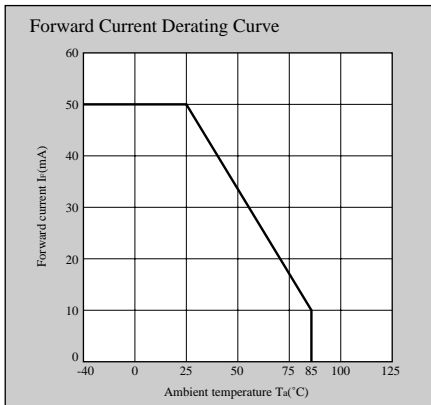

ZE series

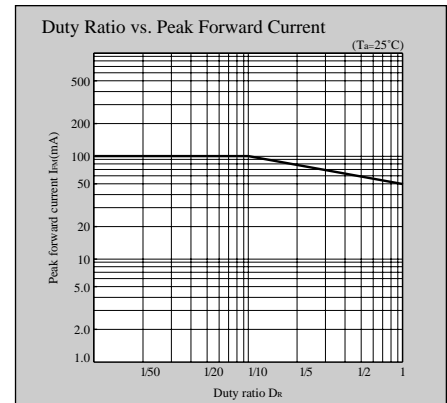
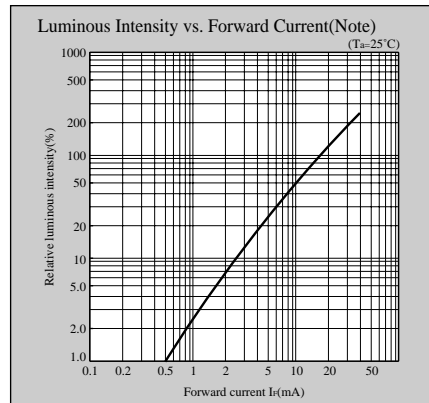
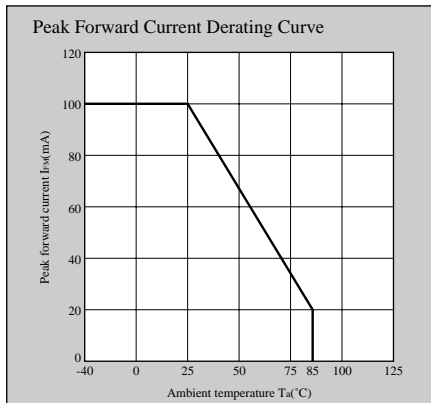
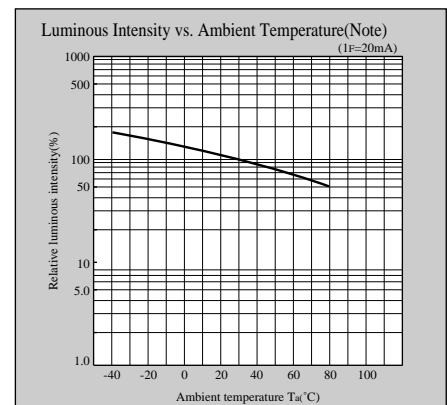
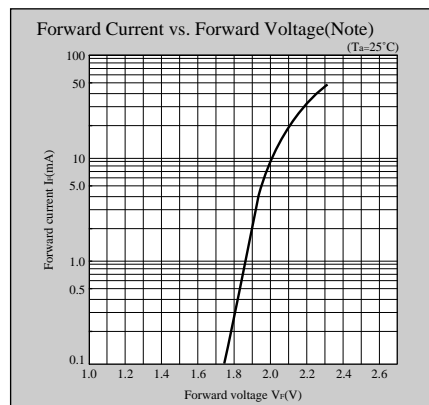
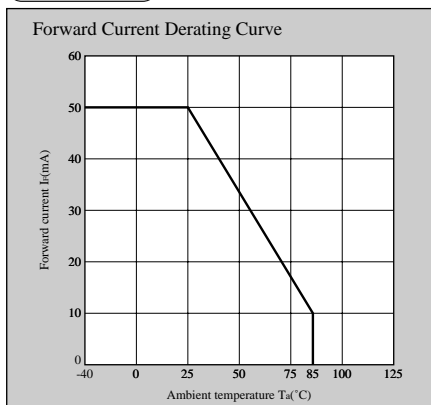

Note) Characteristics shown in diagrams are typical values. (not assurance value)

Characteristics Diagrams

ZG series

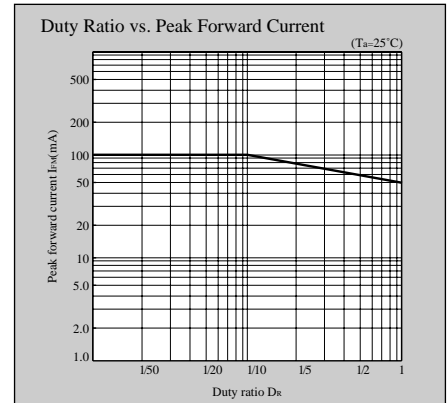
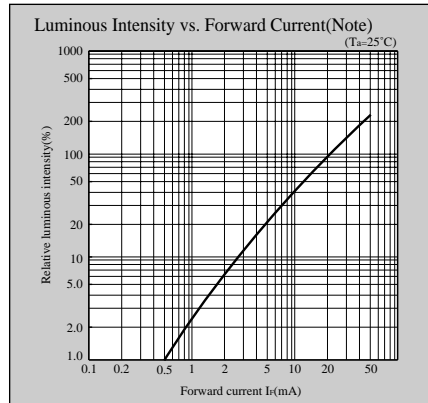
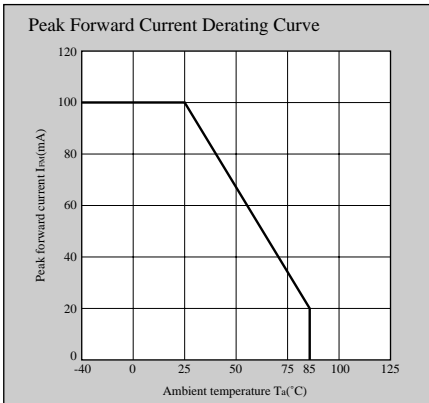
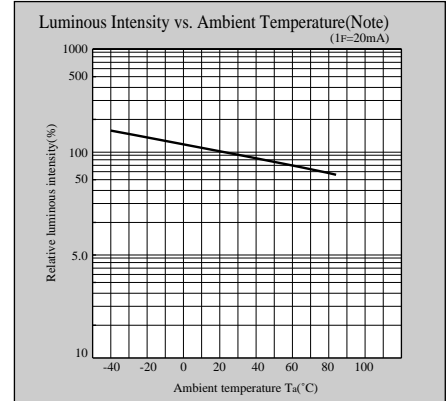
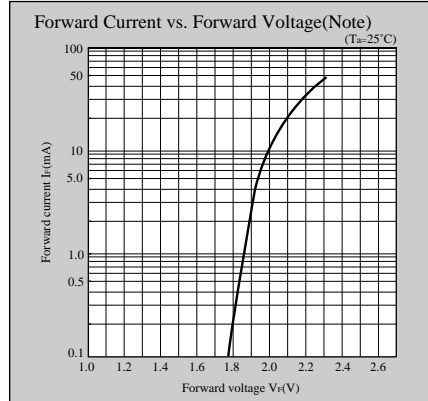
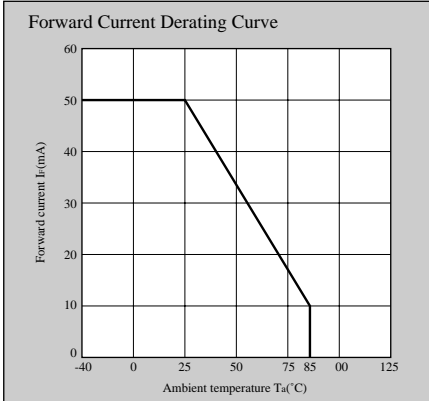

UR,U series

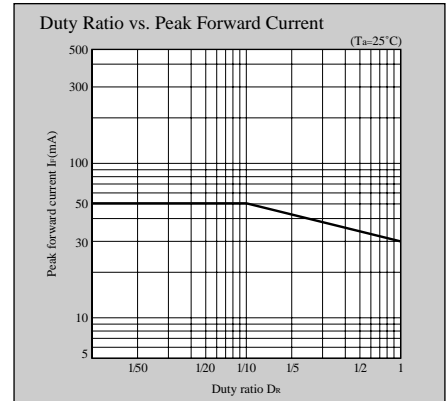
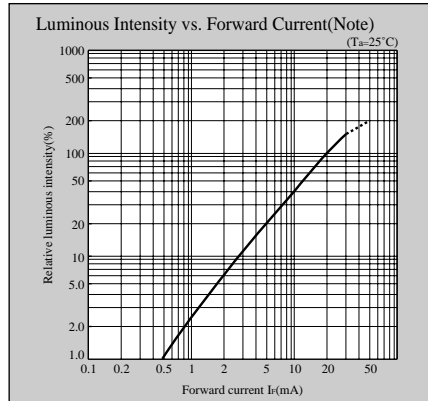
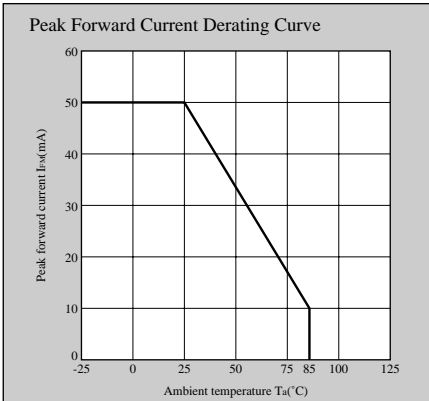
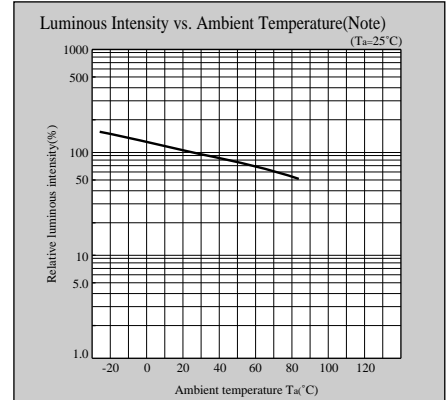
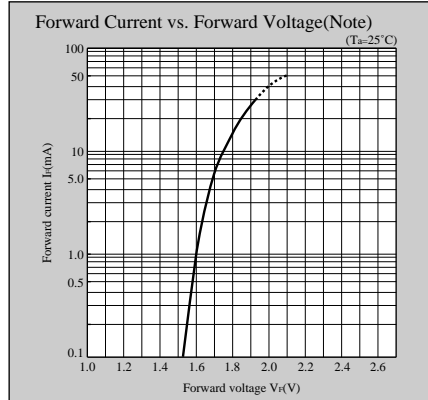
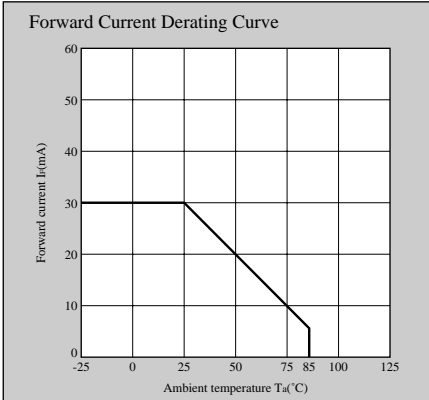

Note) Characteristics shown in diagrams are typical values. (not assurance value)

Notice In the absence of confirmation by device specification sheets, SHARP takes no responsibility for any defects that may occur in equipment using any SHARP devices shown in catalogs, data books, etc. Contact SHARP in order to obtain the latest device specification sheets before using any SHARP device.
Internet Internet address for Electronic Components Group <http://sharp-world.com/ecg/>

Characteristics Diagrams

TR,T series

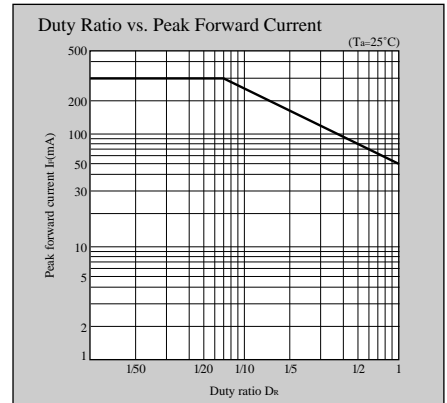
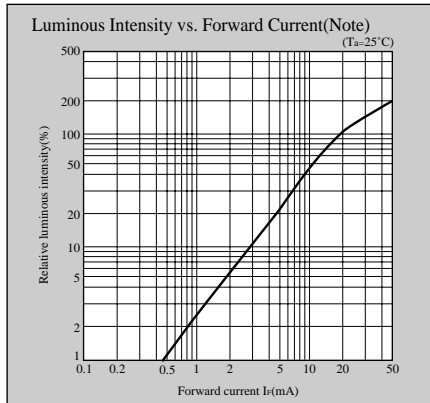
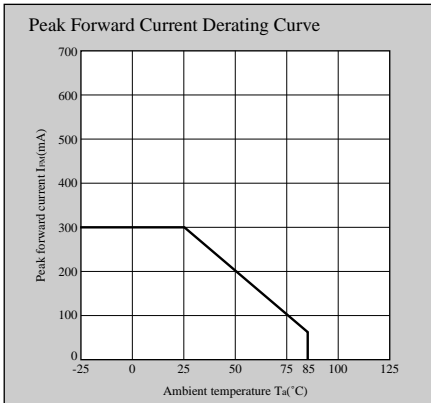
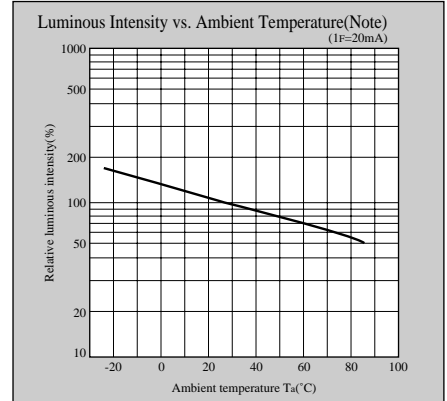
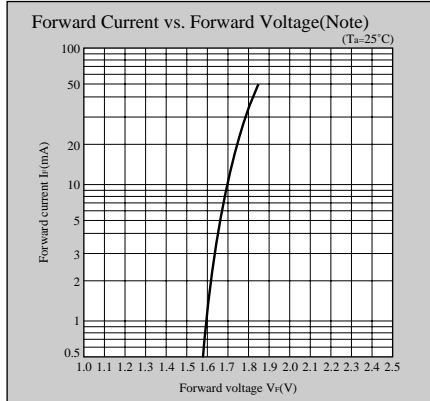
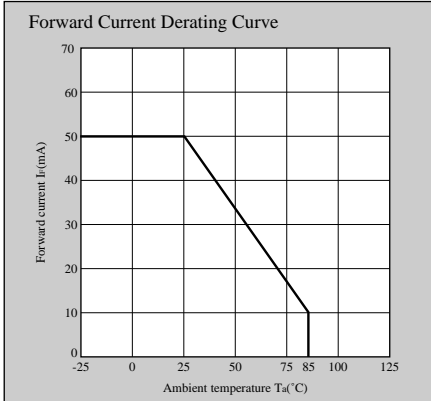

PR,P series

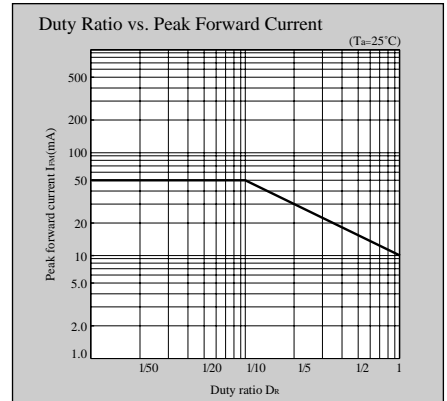
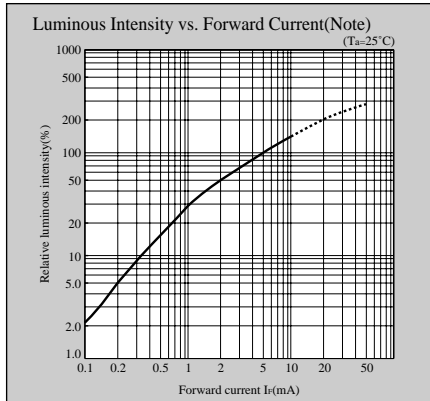
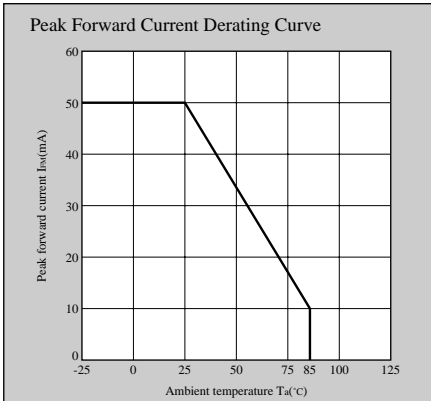
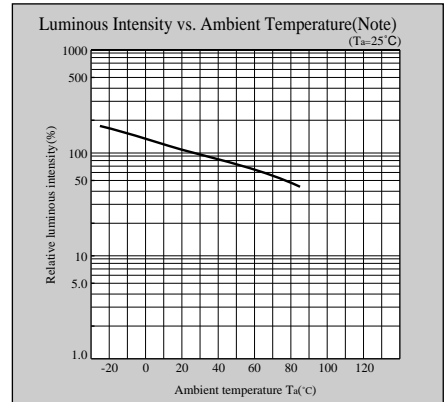
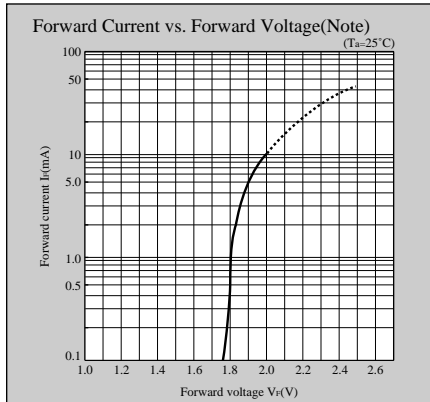
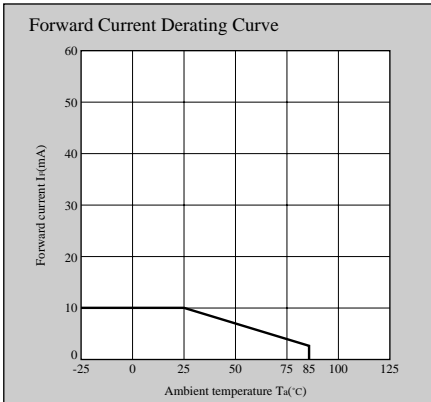

Note) Characteristics shown in diagrams are typical values. (not assurance value)

Characteristics Diagrams

HD,D series

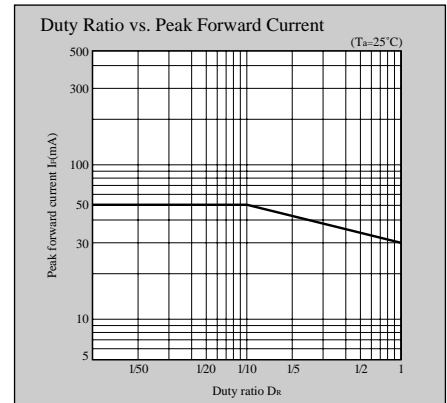
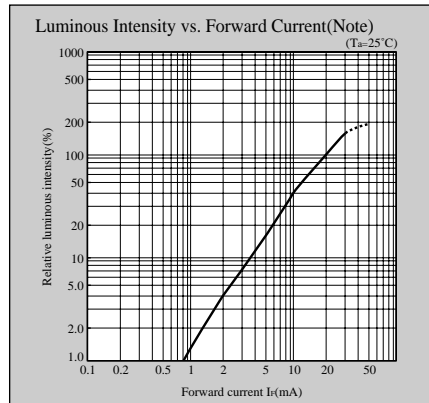
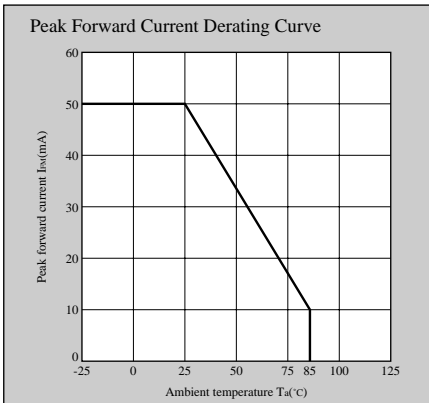
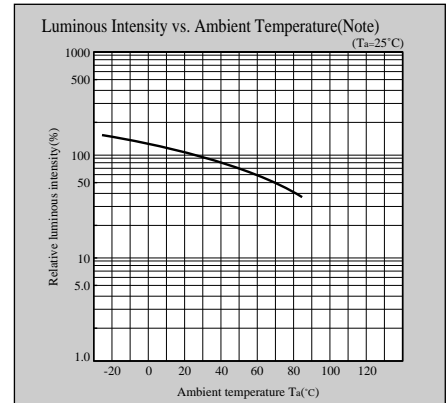
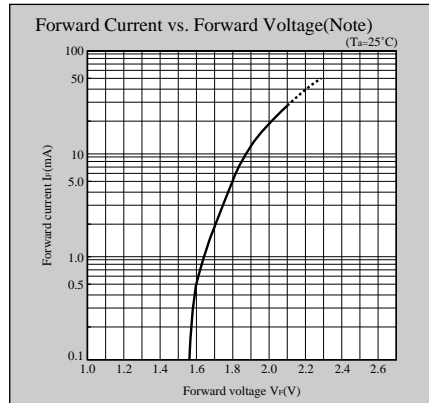
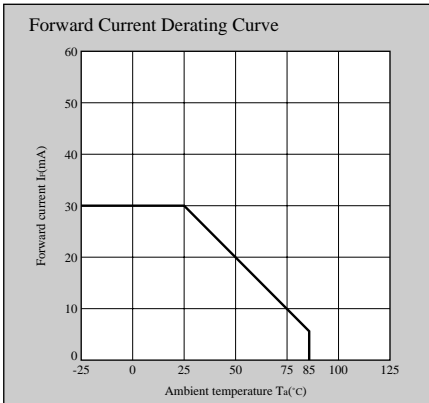

HS,S series

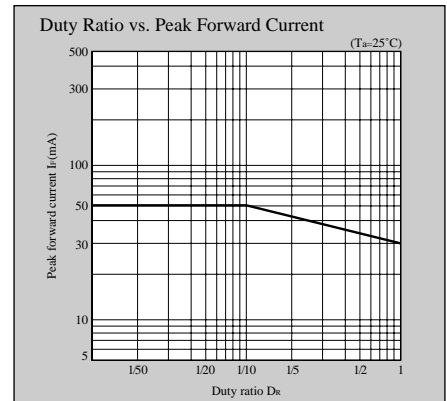
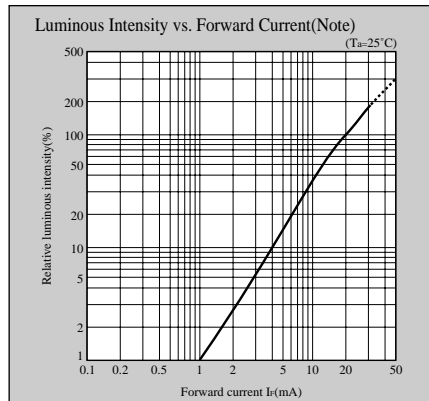
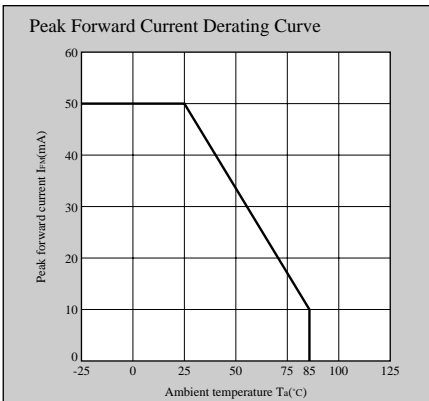
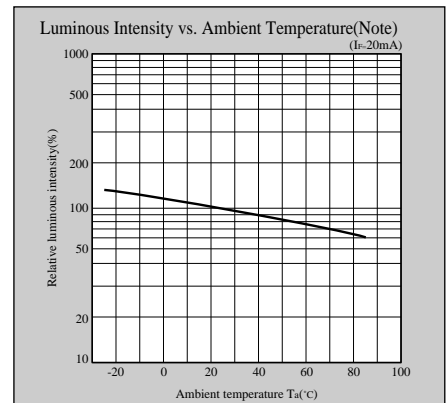
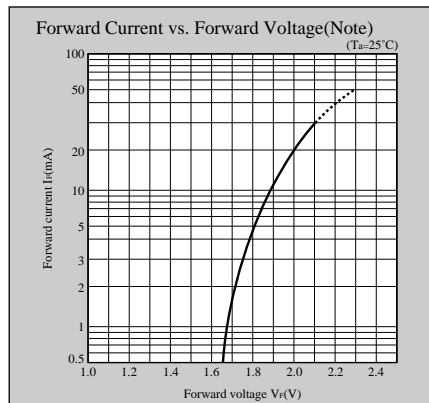
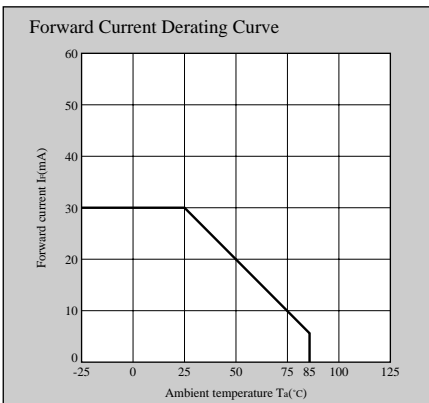

Note) Characteristics shown in diagrams are typical values. (not assurance value)

Notice In the absence of confirmation by device specification sheets, SHARP takes no responsibility for any defects that may occur in equipment using any SHARP devices shown in catalogs, data books, etc. Contact SHARP in order to obtain the latest device specification sheets before using any SHARP device.

Internet Internet address for Electronic Components Group <http://sharp-world.com/ecg/>

Characteristics Diagrams

HY,H series

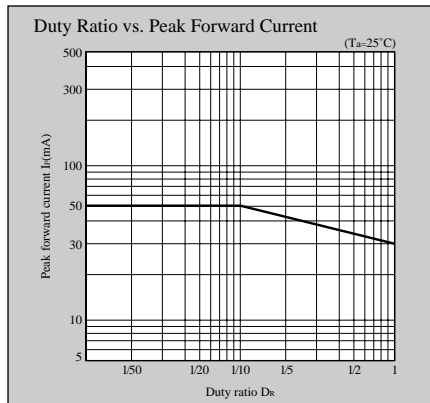
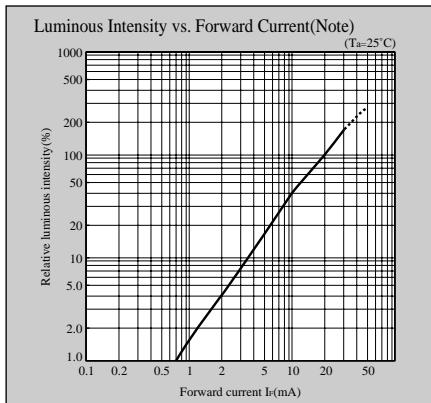
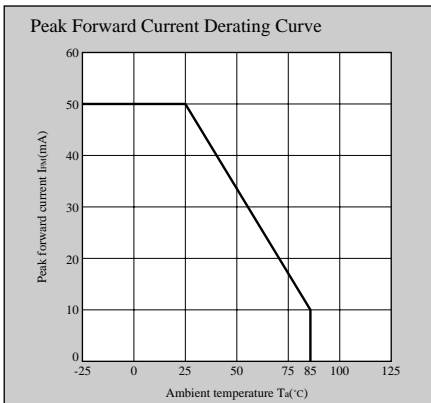
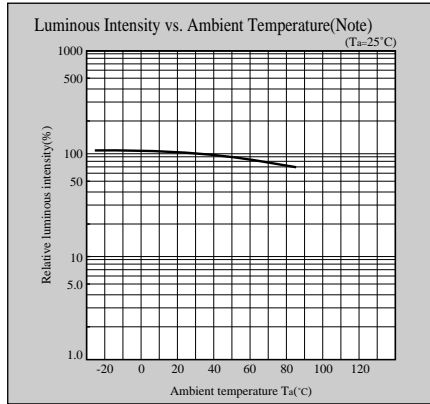
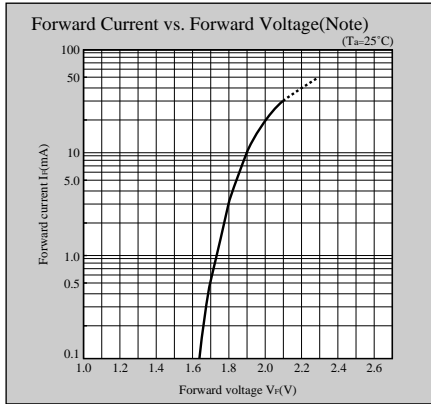
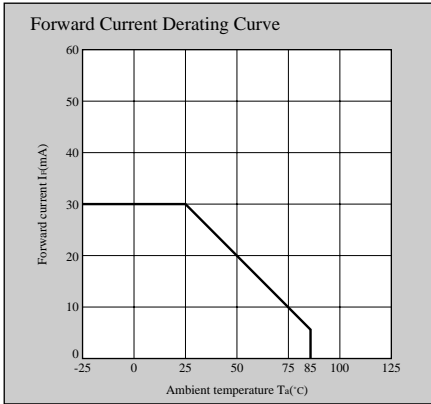

EG,E series

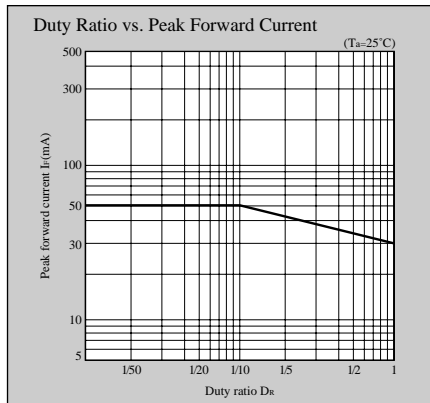
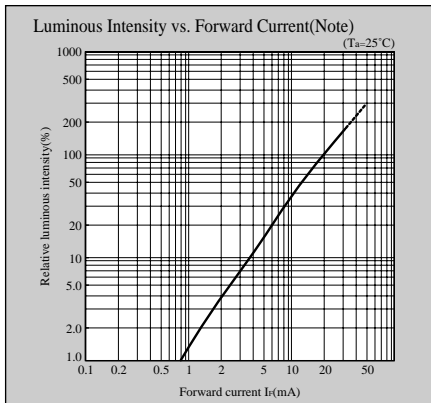
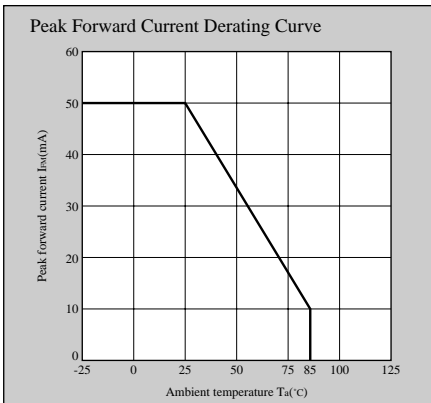
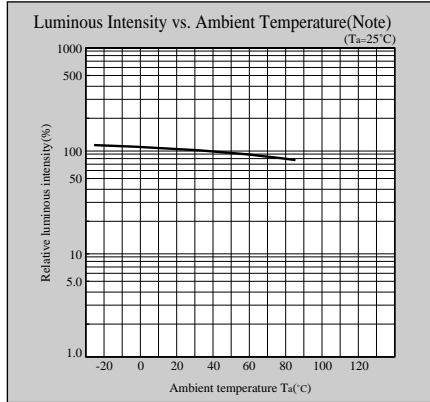
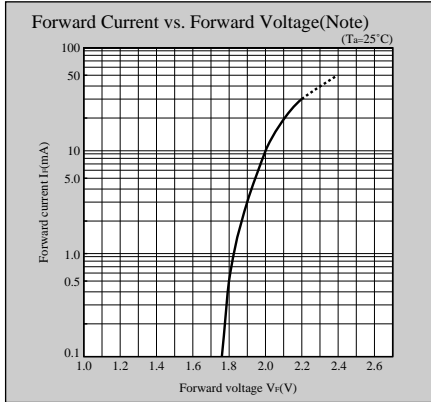
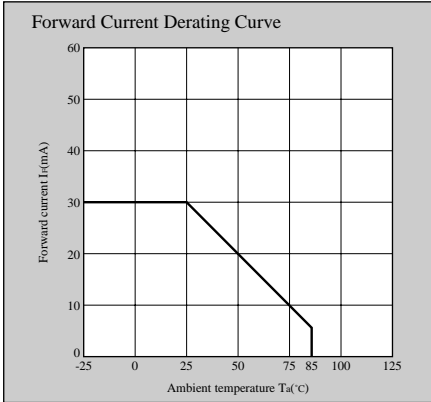

Note) Characteristics shown in diagrams are typical values. (not assurance value)

Characteristics Diagrams

KG,K series

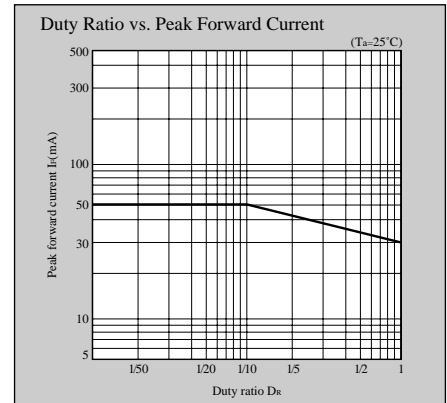
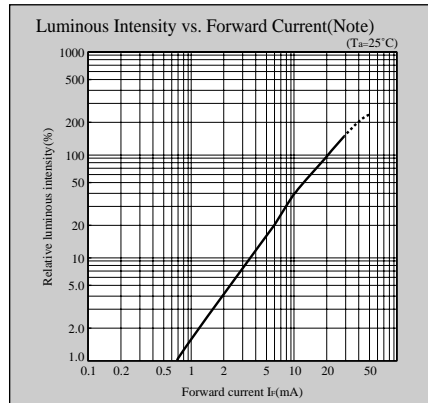
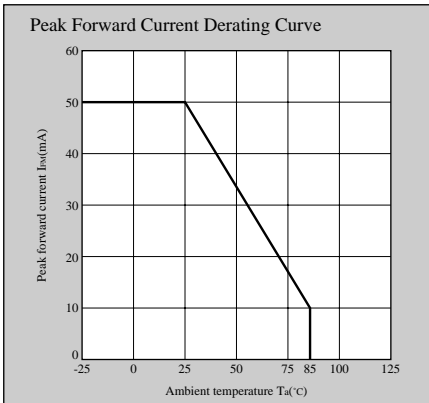
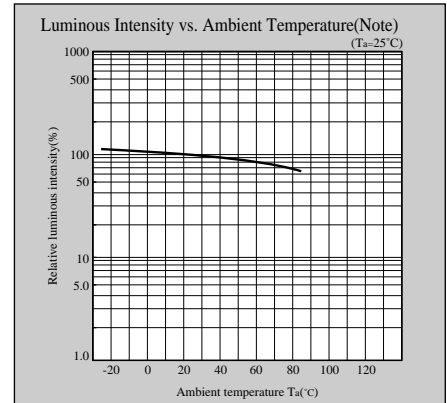
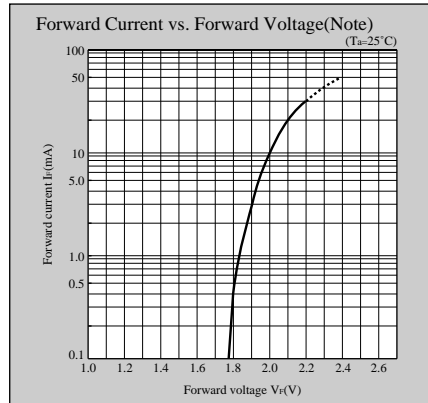
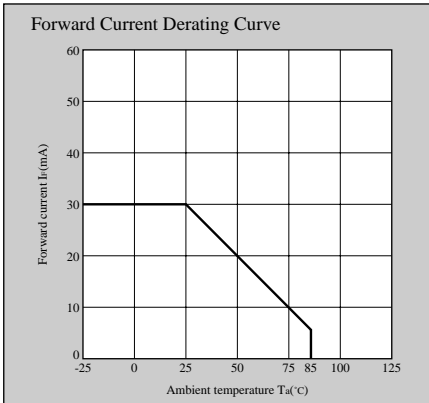

B series

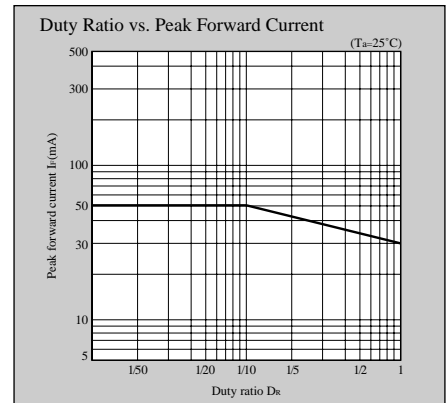
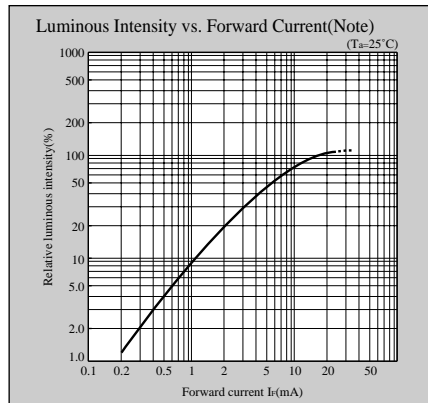
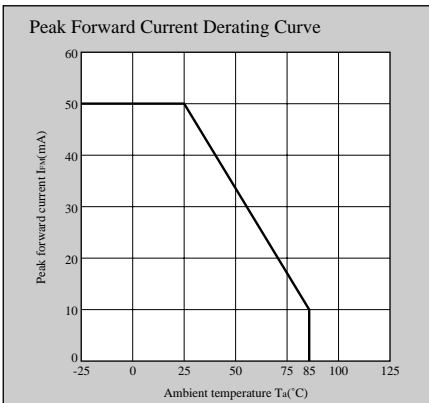
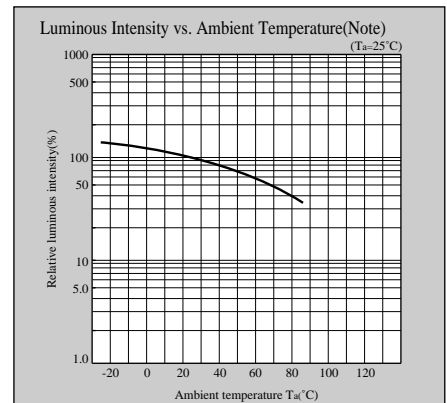
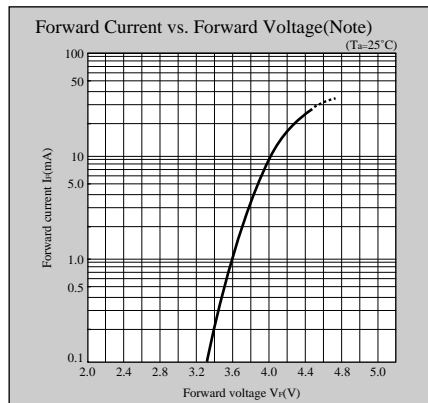
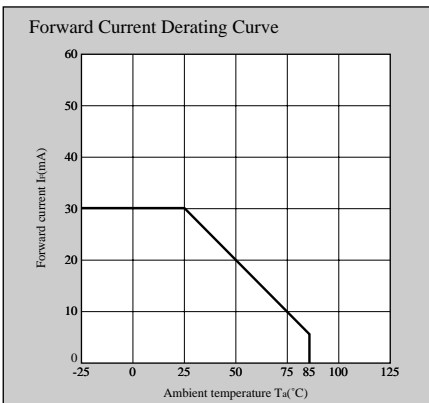

Note) Characteristics shown in diagrams are typical values. (not assurance value)

Notice In the absence of confirmation by device specification sheets, SHARP takes no responsibility for any defects that may occur in equipment using any SHARP devices shown in catalogs, data books, etc. Contact SHARP in order to obtain the latest device specification sheets before using any SHARP device.

Internet Internet address for Electronic Components Group <http://sharp-world.com/ecg/>

Characteristics Diagrams

GL3BC402B0SC/GL3GC402B0SC

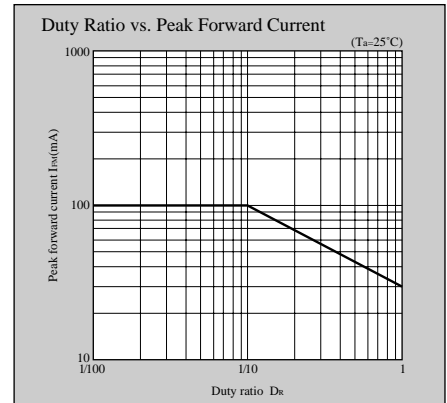
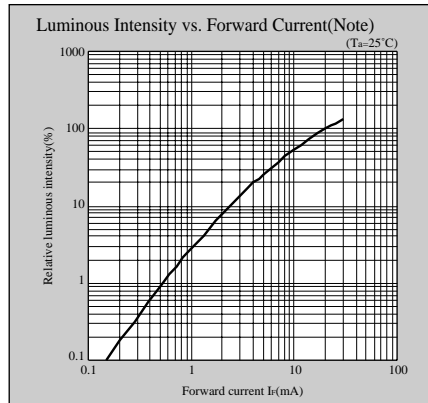
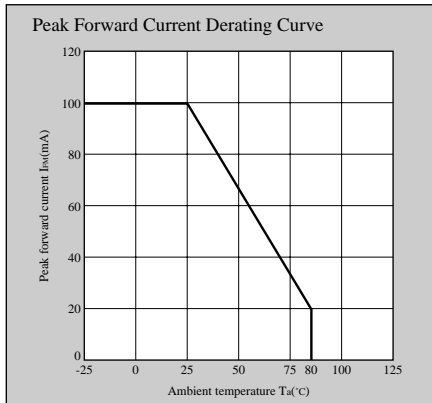
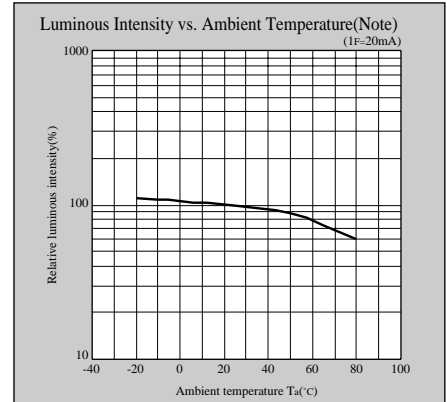
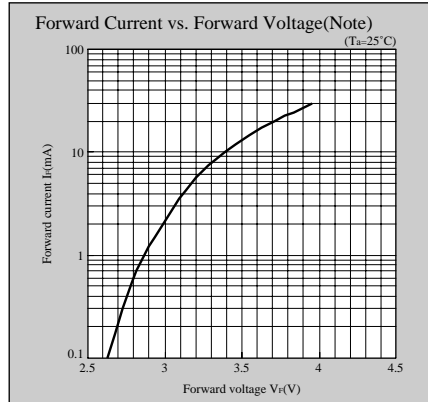
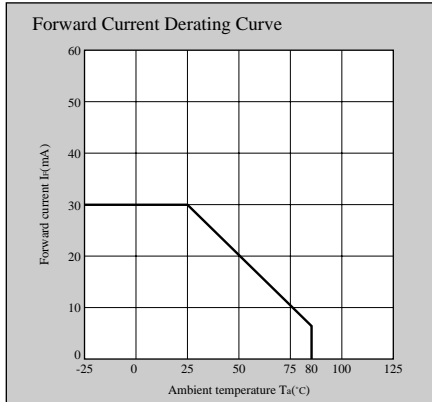

Note) Characteristics shown in diagrams are typical values. (not assurance value)

Taping Specifications

■ General Description

Sharp can supply tape-packaged LED lamps for automatic mounting. They will contribute to the high-efficiency mounting, high-precision, power saving. Please confirm before use because some products are not available in taping package.

■ Taping specification(Unit : mm, TYP. value)

