

# UTCKSC945

# NPNEPITAXIAL SILICON TRANSISTOR

## AUDIO FREQUENCY AMPLIFIER HIGH FREQUENCY OSC NPN TRANSISTOR

### DESCRIPTION

The UTC KSC945 is an audio frequency amplifier high frequency OSC NPN transistor.

### FEATURES

- \*Collector-Base voltage:  
BV<sub>CBO</sub>=60V
- \*Collector current up to 150mA
- \*High hFE linearity
- \*Complimentary to KSA733

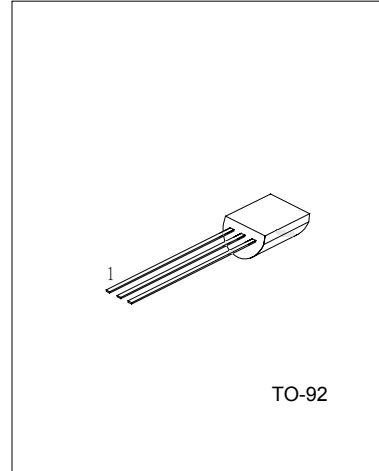

1:EMITTER 2: BASE 3: COLLECTOR

### ABSOLUTE MAXIMUM RATINGS (Ta=25°C, unless otherwise specified )

PARAMETER	SYMBOL	VALUE	UNIT
Collector-Base Voltage	V <sub>CBO</sub>	60	V
Collector-Emitter Voltage	V <sub>CEO</sub>	50	V
Emitter-Base Voltage	V <sub>EBO</sub>	5	V
Collector Dissipation(Ta=25°C)	P <sub>c</sub>	250	mW
Collector Current	I <sub>c</sub>	150	mA
Base Current	I <sub>B</sub>	50	mA
Junction Temperature	T <sub>j</sub>	150	°C
Storage Temperature	T <sub>STG</sub>	-55 ~ +150	°C

### ELECTRICAL CHARACTERISTICS (Ta=25°C, unless otherwise specified)

PARAMETER	SYMBOL	TEST CONDITIONS	MIN	TYP	MAX	UNIT
Collector-Base Breakdown Voltage	BV <sub>CBO</sub>	I <sub>c</sub> =100μA, I <sub>E</sub> =0	60			V
Collector-Emitter Breakdown Voltage	BV <sub>CEO</sub>	I <sub>c</sub> =10mA, I <sub>B</sub> =0	50			V
Collector Cut-Off Current	I <sub>cBO</sub>	V <sub>CB</sub> =40V, I <sub>E</sub> =0			100	nA
Emitter Cut-Off Current	I <sub>EBO</sub>	V <sub>EB</sub> =3V, I <sub>c</sub> =0			100	nA
DC Current Gain(note)	h <sub>FE</sub>	V <sub>CE</sub> =6V, I <sub>c</sub> =1mA	40		700	
Collector-Emitter Saturation Voltage	V <sub>CE(sat)</sub>	I <sub>c</sub> =100mA, I <sub>B</sub> =10mA		0.1	0.3	V
Current Gain Bandwidth Product	f <sub>T</sub>	V <sub>CE</sub> =10V, I <sub>c</sub> =50mA	100	190		MHz
Output Capacitance	C <sub>ob</sub>	V <sub>CB</sub> =10V, I <sub>E</sub> =0, f=1MHz		2.0	3.0	pF
Noise Figure	NF	I <sub>c</sub> =0.1mA, V <sub>CE</sub> =6V R <sub>G</sub> =10kΩ, f=100Hz		4.0	6.0	dB

CLASSIFICATION OF hFE

RANK	R	O	Y	G	L
RANGE	40-80	70-140	120-240	200-400	350-700

TYPICAL PERFORMANCE CHARACTERISTICS

Fig.1 Static characteristics

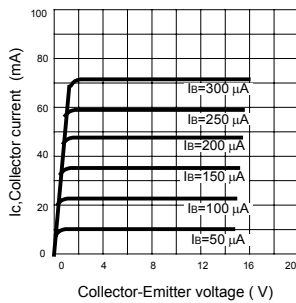

Fig.2 DC current Gain

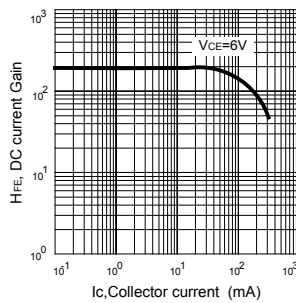

Fig.3 Base-Emitter on Voltage

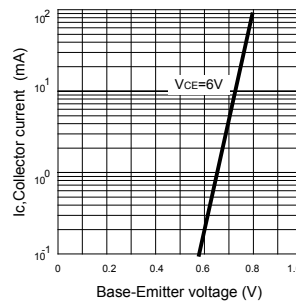

Fig.4 Saturation voltage

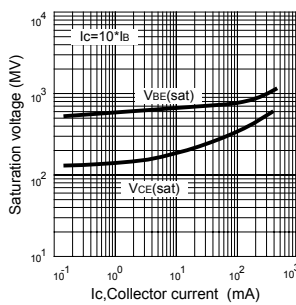

Fig.5 Current gain-bandwidth product

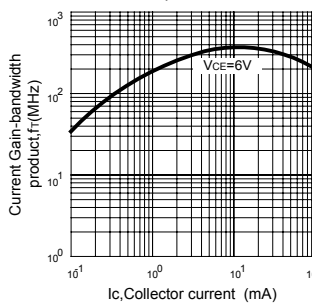
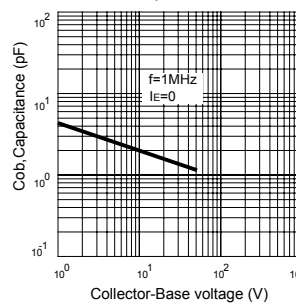

Fig.6 Collector output Capacitance



UTC assumes no responsibility for equipment failures that result from using products at values that exceed, even momentarily, rated values (such as maximum ratings, operating condition ranges, or other parameters) listed in products specifications of any and all UTC products described or contained herein. UTC products are not designed for use in life support appliances, devices or systems where malfunction of these products can be reasonably expected to result in personal injury. Reproduction in whole or in part is prohibited without the prior written consent of the copyright owner. The information presented in this document does not form part of any quotation or contract, is believed to be accurate and reliable and may be changed without notice.