

524,288 WORDS × 8 BIT STATIC RAM

DESCRIPTION

The TC554001FL/FTL is a 4,194,304-bit static random access memory (SRAM) organized as 524,288 words by 8 bits. Fabricated using Toshiba's CMOS Silicon gate process technology, this device operates from a single 3.0 to 5.5V power supply. Advanced circuit technology provides both high speed and low power at an operating current of 10mA/MHz(typ) and minimum cycle time of 70 ns. It is automatically placed in low-power mode at 60 μ A standby current (max) when chip enable (\overline{CE}) is asserted high. There are two control inputs. \overline{CE} is used to select the device and for data retention control, and output enable (\overline{OE}) provides fast memory access. This device is well suited to various microprocessor system applications where high speed, low power and battery backup are required. The TC554001FL/FTL is available in a standard plastic 32-pin small-outline package (SOP) and 32-pin thin-small-outline package (TSOP).

FEATURES

- Low-power dissipation
Operating: 55 mW/MHz (typical)
- Standby current of 8 μ A (maximum) at
 $T_a = 25^\circ\text{C}$
- Single power supply voltage of 3.0 to 5.5 V
- Power down features using \overline{CE}
- Data retention supply voltage of 2.0 to 5.5 V
- Direct TTL compatibility for all inputs and outputs

Access Time (maximum)

	5 V \pm 10%			3.0 to 5.5 V
	-70 V	-85 V	-10 V	-70 V/85 V/-10 V
Access Time	70 ns	85 ns	100 ns	150 ns
\overline{CE} Access Time	70 ns	85 ns	100 ns	150 ns
\overline{OE} Access Time	35 ns	45 ns	50 ns	75 ns

Package:

- SOP32-P-525-1.27 (FL) (Weight: 1.14 g typ)
- TSOP II 32-P-400-1.27 (FTL) (Weight: 0.51 g typ)

PIN ASSIGNMENT (TOP VIEW)

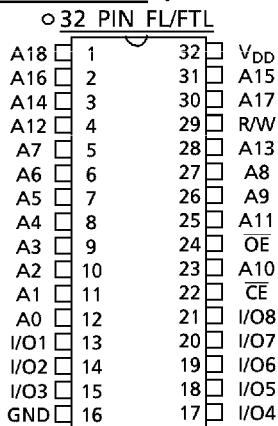

PIN NAMES

A0 to A18	Address Inputs
R/W	Read/Write Control
\overline{OE}	Output Enable
\overline{CE}	Chip Enable
I/O1 to I/O8	Data Input/Output
V _{DD}	Power
GND	Ground

BLOCK DIAGRAM

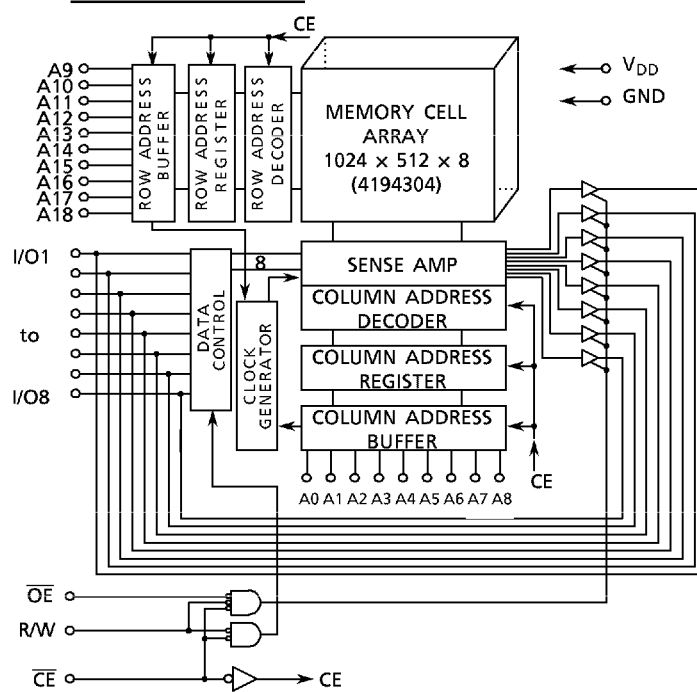

961001EBA1

- TOSHIBA is continually working to improve the quality and the reliability of its products. Nevertheless, semiconductor devices in general can malfunction or fail due to their inherent electrical sensitivity and vulnerability to physical stress. It is the responsibility of the buyer, when utilizing TOSHIBA products, to observe standards of safety, and to avoid situations in which a malfunction or failure of a TOSHIBA product could cause loss of human life, bodily injury or damage to property. In developing your designs, please ensure that TOSHIBA products are used within specified operating ranges as set forth in the most recent products specifications. Also, please keep in mind the precautions and conditions set forth in the TOSHIBA Semiconductor Reliability Handbook.
- The products described in this document are subject to foreign exchange and foreign trade control laws.
- The information contained herein is presented only as a guide for the applications of our products. No responsibility is assumed by TOSHIBA CORPORATION for any infringements of intellectual property or other rights of the third parties which may result from its use. No license is granted by implication or otherwise under any intellectual property or other rights of TOSHIBA CORPORATION or others.
- The information contained herein is subject to change without notice.

OPERATION MODE

OPERATION MODE	\overline{CE}	\overline{OE}	R/W	I/O1 to I/O8	POWER
Read	L	L	H	D _{OUT}	I _{DDO}
Write	L	x	L	D _{IN}	I _{DDO}
Output Disabled	L	H	H	High-Z	I _{DDO}
Standby	H	x	x	High-Z	I _{DDS}

Note: x = don't care. H=logic high. L=logic low.

ABSOLUTE MAXIMUM RATINGS

SYMBOL	RATING	VALUE	UNIT
V _{DD}	Power Supply Voltage	- 0.3 to 7.0	V
V _{IN}	Input Voltage	- 0.3* to 7.0	V
V _{I/O}	Input and Output Voltage	- 0.5 to V _{DD} + 0.5	V
P _D	Power Dissipation	0.6	W
T _{solder}	Soldering Temperature (10 s)	260	°C
T _{strg.}	Storage Temperature	- 55 to 150	°C
T _{opr.}	Operating Temperature	0 to 70	°C

* - 3.0 V when measured at a pulse width of 50 ns

DC RECOMMENDED OPERATING CONDITIONS (Ta = 0° to 70°C)

SYMBOL	PARAMETER	5 V ± 10%			3.0 to 5.5			UNIT
		MIN	TYP	MAX	MIN	TYP	MAX	
V _{DD}	Power Supply Voltage	4.5	5.0	5.5	3.0	5.0	5.5	V
V _{IH}	Input High Voltage	2.2	-	V _{DD} + 0.3	V _{DD} - 0.2	-	V _{DD} + 0.3	V
V _{IL}	Input Low Voltage	- 0.3*	-	0.8	- 0.3*	-	0.2	V
V _{DH}	Data Retention Supply Voltage	2.0	-	5.5	2.0	-	5.5	V

* - 3.0 V when measured at a pulse width of 50 ns

DC CHARACTERISTICS (Ta = 0° to 70°C, VDD = 5 V ± 10%)

SYMBOL	PARAMETER	TEST CONDITION		MIN	TYP	MAX	UNIT	
I _{IL}	Input Leakage Current	V _{IN} = 0 V to V _{DD}		-	-	± 1.0	μA	
I _{LO}	Output Leakage Current	$\overline{CE} = V_{IH}$ or $\overline{OE} = V_{IH}$ or R/W = V _{IL} V _{OUT} = 0 V to V _{DD}		-	-	± 1.0	μA	
I _{OH}	Output High Current	V _{OH} = 2.4 V		- 1.0	-	-	mA	
I _{OL}	Output Low Current	V _{OL} = 0.4 V		2.1	-	-	mA	
I _{DDO1}	Operating Current	CE = V _{IL} and R/W = V _{IH} I _{OUT} = 0 mA Other Inputs = V _{IH} /V _{IL}	Tcycle	min	-	-	80	mA
				1 μs	-	15	-	
I _{DDO2}	Operating Current	CE = 0.2 V and R/W = V _{DD} -0.2 V I _{OUT} = 0 mA Other Inputs = V _{DD} -0.2 V/0.2 V	Tcycle	min	-	-	70	mA
				1 μs	-	10	-	
I _{DDS1}	Standby Current	CE = V _{IH}		-	-	3	μA	
I _{DDS2}		V _{DD} = 2.0 to 5.5 V	Ta = 25°C		-	4		8
			Ta = 0° to 70°C		-	-		60
		V _{DD} = 3.0 V	Ta = 25°C		-	2		-
	Ta = 0 to 40°C		-	-	6			
		Ta = 0° to 70°C		-	-	30		

DC CHARACTERISTICS (Ta = 0° to 70°C, VDD = 3.3 V ± 0.3 V)

SYMBOL	PARAMETER	TEST CONDITION		MIN	TYP	MAX	UNIT		
I _{IL}	Input Leakage Current	V _{IN} = 0 V to V _{DD}		-	-	± 1.0	μA		
I _{LO}	Output Leakage Current	$\overline{CE} = V_{IH}$ or $\overline{OE} = V_{IH}$ or R/W = V _{IL} V _{OUT} = 0 V to V _{DD}		-	-	± 1.0	μA		
I _{OH}	Output High Current	V _{OH} = V _{DD} -0.2 V		- 0.1	-	-	mA		
I _{OL}	Output Low Current	V _{OL} = 0.2 V		0.1	-	-	mA		
I _{DDO2}	Operating Current	CE = 0.2 V and R/W = V _{DD} -0.2 V I _{OUT} = 0 mA Other Inputs = V _{DD} -0.2 V/0.2 V	Tcycle	min	-	-	35	mA	
				1 μs	-	5	-		
I _{DDS2}	Standby Current	CE = V _{DD} -0.2 V	V _{DD} = 3.3 ± 0.3 V	Ta = 25°C		-	2	4	μA
				Ta = 0° to 70°C		-	-	40	
			V _{DD} = 3.3 V	Ta = 25°C		-	2	-	
				Ta = 0 to 40°C		-	-	8	
		Ta = 0° to 70°C		-	-	35			

CAPACITANCE (Ta = 25°C, f = 1 MHz)

SYMBOL	PARAMETER	TEST CONDITION	MAX	UNIT
C _{IN}	Input Capacitance	V _{IN} = GND	10	pF
C _{OUT}	Output Capacitance	V _{OUT} = GND	10	pF

Note: This parameter is periodically sampled and is not 100% tested.

AC CHARACTERISTICS AND OPERATING CONDITIONS (Ta = 0° to 70°C, VDD = 5 V ± 10%)

READ CYCLE

SYMBOL	PARAMETER	TC554001FL/FTL						UNIT
		-70 V		-85 V		-10 V		
		MIN	MAX	MIN	MAX	MIN	MAX	
t _{RC}	Read Cycle Time	70	-	85	-	100	-	ns
t _{ACC}	Address Access Time	-	70	-	85	-	100	
t _{CO}	Chip Enable Accses Time	-	70	-	85	-	100	
t _{OE}	Output Enable Accses Time	-	35	-	45	-	50	
t _{COE}	Chip Enable Low to Output Active	10	-	10	-	10	-	
t _{OEE}	Output Enable Low to Output Active	5	-	5	-	5	-	
t _{OD}	Chip Enable Hige to Output High-Z	-	25	-	30	-	35	
t _{ODO}	Output Enable Hige to Output High-Z	-	25	-	30	-	35	
t _{OH}	Output Data Hold Time	10	-	10	-	10	-	

WRITE CYCLE

SYMBOL	PARAMETER	TC554001FL/FTL						UNIT
		-70 V		-85 V		-10 V		
		MIN	MAX	MIN	MAX	MIN	MAX	
t _{WC}	Write Cycle Time	70	-	85	-	100	-	ns
t _{WP}	Write Pulse Width	50	-	55	-	60	-	
t _{CW}	Chip Enable to End of Write	60	-	70	-	80	-	
t _{AS}	Address Setup Time	0	-	0	-	0	-	
t _{WR}	Write Recovery Time	0	-	0	-	0	-	
t _{ODW}	R/W Low to Output High-Z	-	25	-	25	-	25	
t _{OEW}	R/W High to Output Active	5	-	5	-	5	-	
t _{DS}	Data Setup Time	30	-	35	-	40	-	
t _{DH}	Data Hold Time	0	-	0	-	0	-	

AC TEST CONDITIONS

Output Load: 30 pF + one TTL gate (-70 V)

100 pF + one TTL gate (-85 V, -10 V)

Input Pulse Level: 0.6 V, 2.4 V

Timing Measurements: 1.5 V

Reference Level: 1.5 V

t_r, t_f: 5 ns

AC CHARACTERISTICS AND OPERATING CONDITIONS(Ta = 0° to 70°C, V_{DD} = 3.0 V to 5.5 V)READ CYCLE

SYMBOL	PARAMETER	MIN	MAX	UNIT
t _{RC}	Read Cycle Time	150	–	ns
t _{ACC}	Address Access Time	–	150	
t _{CO}	Chip Enable (\overline{CE}) Access Time	–	150	
t _{OE}	Output Enable to Output in Valid	–	75	
t _{COE}	Chip Enable (\overline{CE}) to Output in Low-Z	10	–	
t _{OEE}	Output Enable to Output in Low-Z	5	–	
t _{OD}	Chip Enable (\overline{CE}) to Output in High-Z	–	50	
t _{ODO}	Output Enable to Output in High-Z	–	50	
t _{OH}	Output Data Hold Time	10	–	

WRITE CYCLE

SYMBOL	PARAMETER	MIN	MAX	UNIT
t _{WC}	Write Cycle Time	150	–	ns
t _{WP}	Write Pulse Width	100	–	
t _{CW}	Chip Enable to End of Write	120	–	
t _{AS}	Address Setup Time	0	–	
t _{WR}	Write Recovery Time	0	–	
t _{ODW}	R/W Low to Output High-Z	–	50	
t _{OEW}	R/W Hige to Output Active	5	–	
t _{DS}	Data Setup Time	60	–	
t _{DH}	Data Hold Time	0	–	

AC TEST CONDITIONS

Output Load: 100 pF (Include Jig)

Input Pulse Level: V_{DD} – 0.2 V/0.2 V

Timing Measurements: 1.5 V

Reference Level: 1.5 V

t_r, t_f : 5 ns

TIMING WAVEFORMS

READ CYCLE (See Note 1)

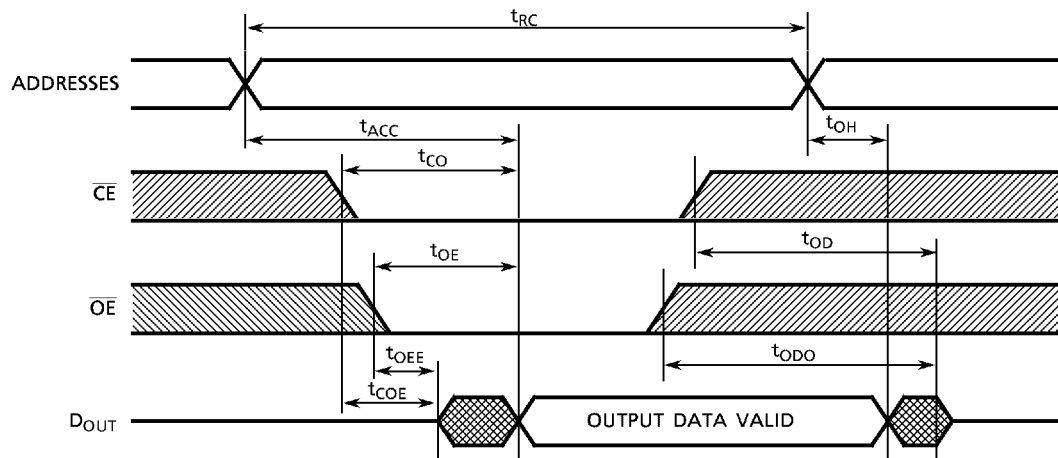

WRITE CYCLE 1 (R/W CONTROLLED) (See Note 4)

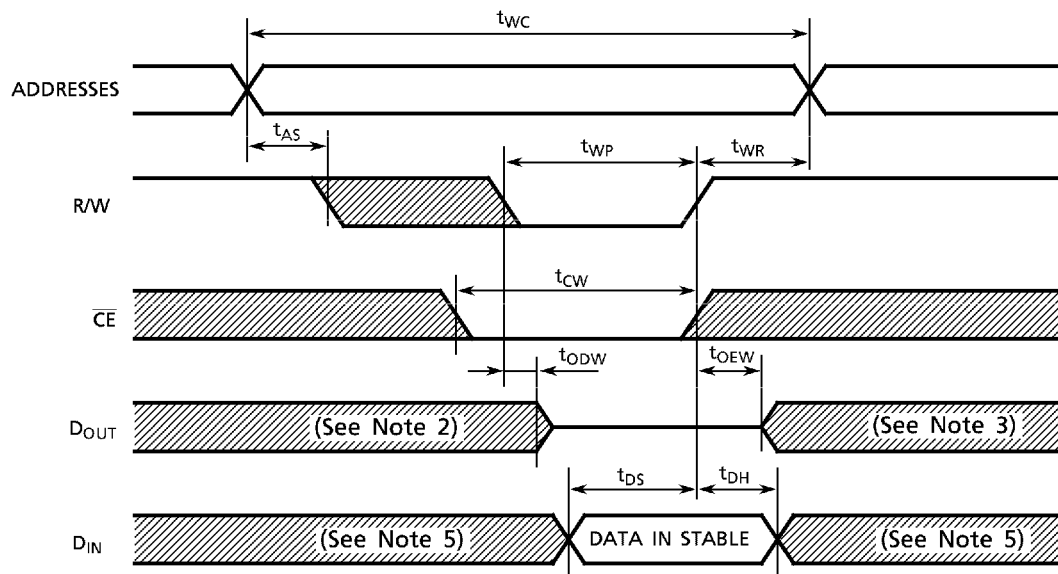

WRITE CYCLE 2 (\overline{CE} CONTROLLED) (See Note 4)

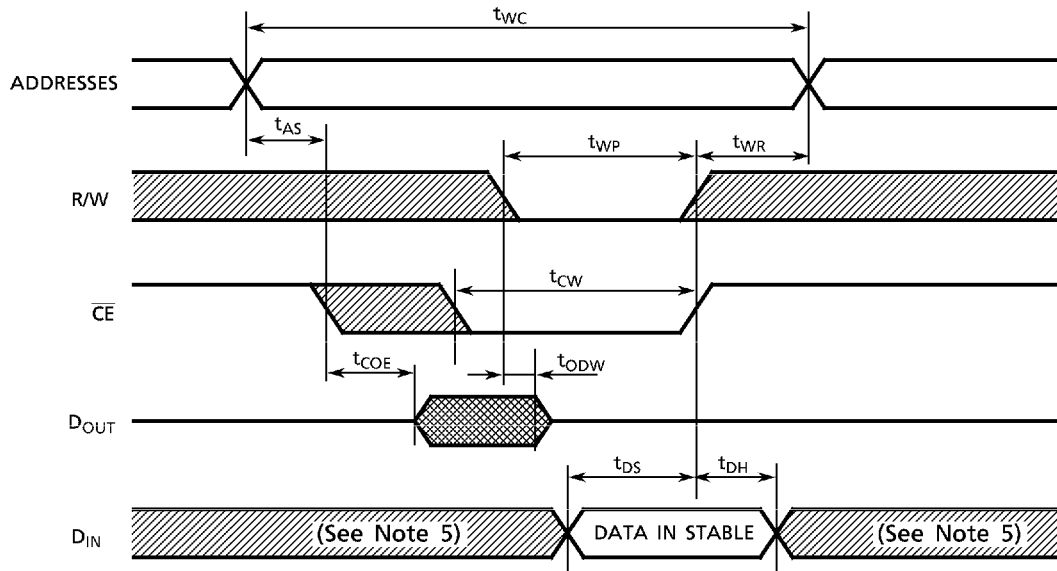

- (1) R/W remains High for Read Cycle.
- (2) If \overline{CE} goes coincident with or after R/W goes LOW, the output will remain at high impedance.
- (3) If \overline{CE} goes HIGH coincident with or before R/W goes HIGH, the output will remain at high impedance.
- (4) IF \overline{CE} is HIGH during the write cycle, the outputs will remain at high impedance.
- (5) Because I/O signals may be in the output state at this time, input signals of reverse polarity must not be applied.

DATA RETENTION CHARACTERISTICS (Ta = 0° to 70°C)

SYMBOL	PARAMETER	MIN	TYP	MAX	UNIT
V _{DH}	Data Retention Supply Voltage	2.0	-	5.5	V
I _{DD52}	Standby Current	V _{DH} = 3.3 V	-	35*	μA
		V _{DH} = 5.5 V	-	60	
t _{CDR}	Chip Deselect to Data Retention Mode Time	0	-	-	nS
t _R	Recovery Time	5	-	-	mS

*) 8 μA (max) Ta = 0° to 40 °C

CE Controlled Data Retention Mode

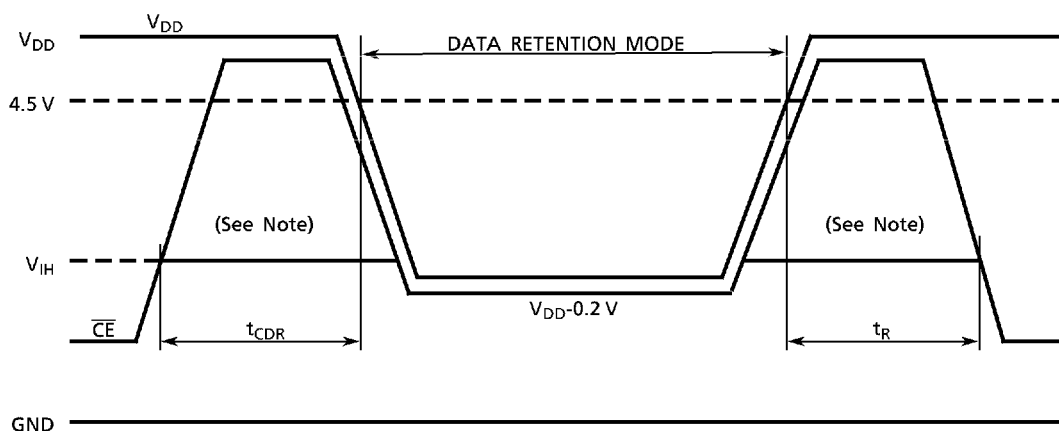

Note: When \overline{CE} is operating at the V_{IH} level (2.2V), the standby current is given by I_{DD51} during the transition of V_{DD} from 4.5 to 2.4V.

PACKAGE DIMENSIONS (SOP32-P-525-1.27)

Unit in mm

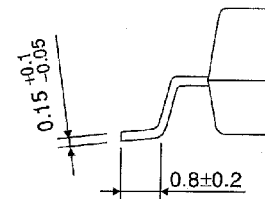
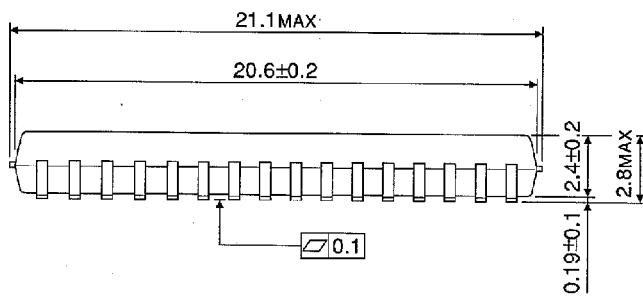
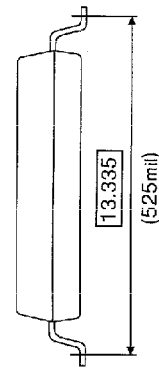
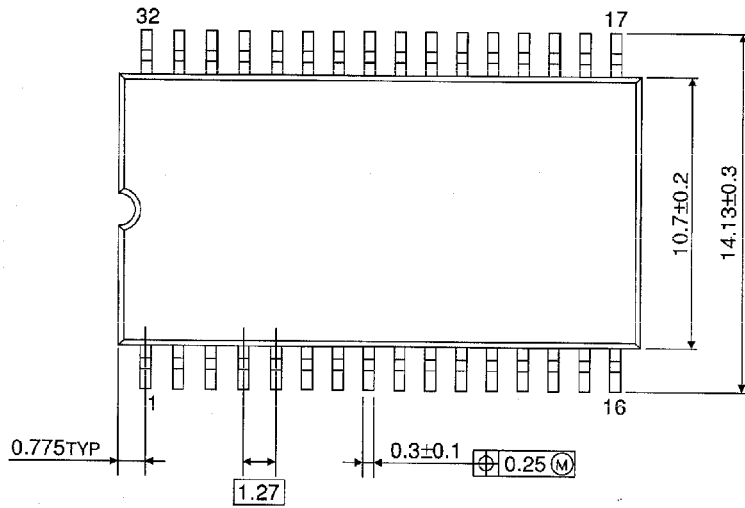

Weight: 1.14 g (typ)

PACKAGE DIMENSIONS (TSOPII 32-P-400-1.27)

Unit in mm

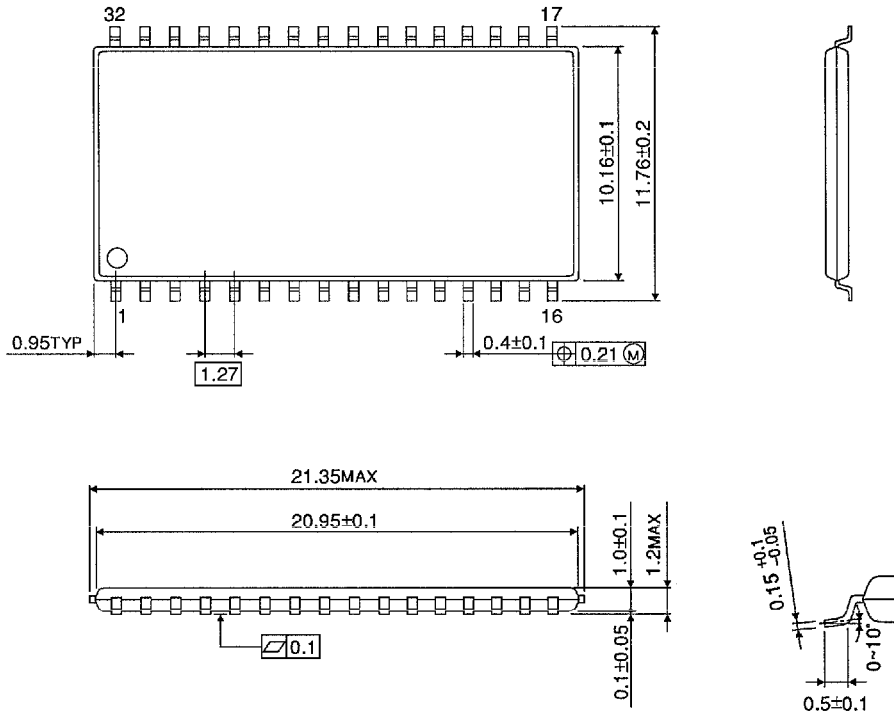

Weight: 0.51 g (typ)