

02P

03P

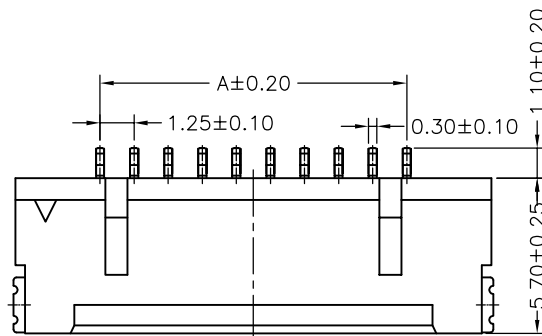

04P~30P

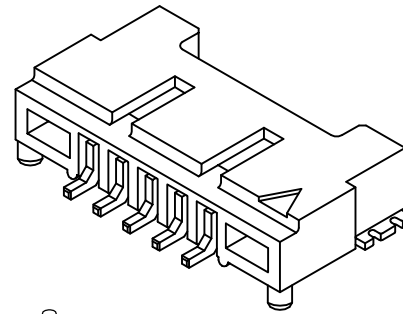
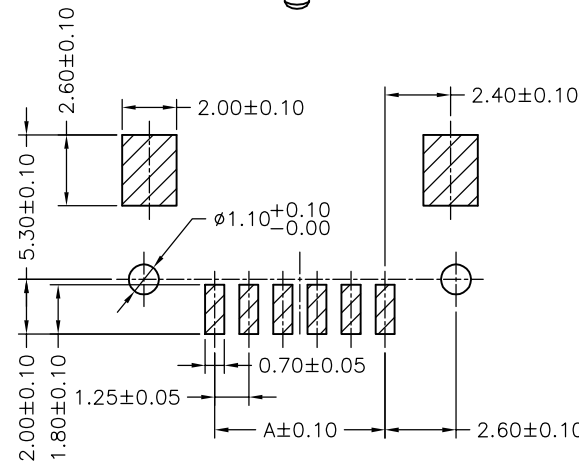

P.C.B. LAYOUT

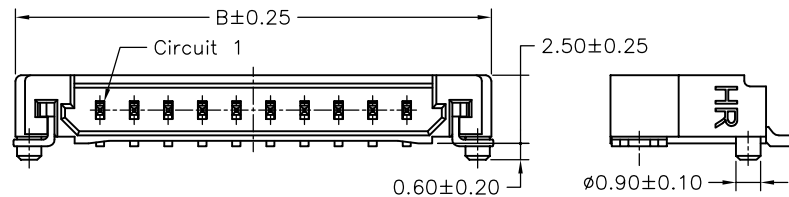

SPECIFICATIONS

Current Rating: 1A AC,DC  
 Voltage Rating: 150V AC,DC  
 Temperature Range:  $-25^{\circ}\text{C} \sim +85^{\circ}\text{C}$   
 Contact Resistance: 30m $\Omega$  Max.  
 Insulation Resistance: 500M $\Omega$  Min.  
 Withstanding Voltage: 500V AC/minute  
 Pin Material: Brass/Tin-plated  
 Solder Tabs: Brass/Tin-plated  
 Material: Nylon 6T,UL94V-0  
 Color: Natural(Beige)

Ordering Information & Dimensions

PART NO.	Dimensions	
	A	B
A1253WR-SF-02P	1.25	7.45
A1253WR-SF-03P	2.50	8.70
A1253WR-SF-04P	3.75	9.95
A1253WR-SF-05P	5.00	11.20
A1253WR-SF-06P	6.25	12.45
A1253WR-SF-07P	7.50	13.70
A1253WR-SF-08P	8.75	14.95
A1253WR-SF-09P	10.00	16.20
A1253WR-SF-10P	11.25	17.45
A1253WR-SF-11P	12.50	18.70
A1253WR-SF-12P	13.75	19.95
A1253WR-SF-13P	15.00	21.20
A1253WR-SF-14P	16.25	22.45
A1253WR-SF-15P	17.50	23.70
A1253WR-SF-20P	23.75	29.95
A1253WR-SF-25P	30.00	36.20
A1253WR-SF-30P	36.25	42.45

				UNIT	SCALE	SHEET	TITLE:
				mm		1 of 2	
		DRAWN BY	APPROVED BY				
		李勤	董正一				
		2005.12.08	2005.12.08				
		GENERAL TOLERANCE					
A1	REVISE	2007.01.03	X.X $\pm$ 0.25	ANGLE $\pm$			
A0	NEW RELEASE	2005.12.08	X.XX $\pm$ 0.15				
REV.	DESCRIPTION	DATE	X.XXX $\pm$ 0.05				
					DRAW NO.:		REV.
					A1253WR-SF-XP		A1

### 02~07 Contacts

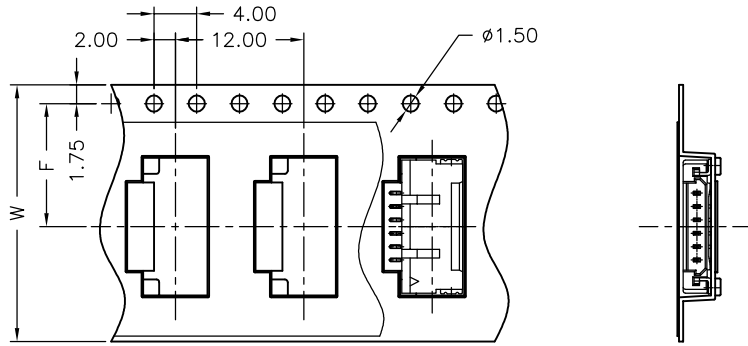

### 08~30 Contacts

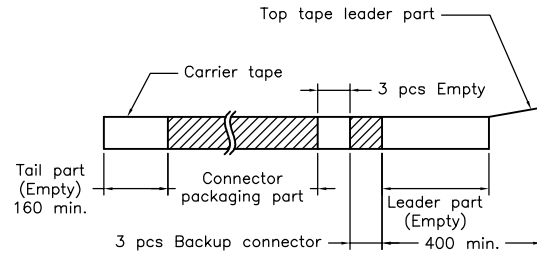
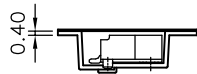
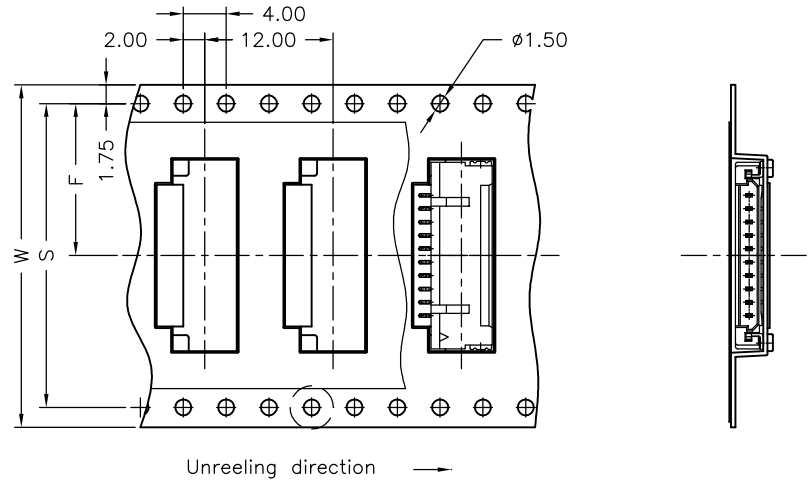

Number of Contacts	W±0.3	F±0.1	S±0.1	Q'ty/Reel
02P	16	7.50	/	1,000
03P	16	7.50		1,000
04P	24	11.50		1,000
05P	24	11.50		1,000
06P	24	11.50		1,000
07P	24	11.50		1,000
08P	32	14.20	28.40	1,000
09P	32	14.20	28.40	1,000
10P	32	14.20	28.40	1,000
11P	32	14.20	28.40	1,000
12P	32	14.20	28.40	1,000
13P	32	14.20	28.40	1,000
14P	44	20.20	40.40	1,000
15P	44	20.20	40.40	1,000
20P	44	20.20	40.40	1,000
25P	56	26.20	52.40	1,000
30P	56	26.20	52.40	1,000

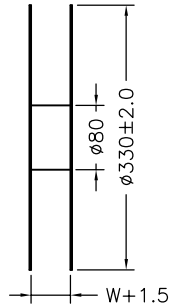
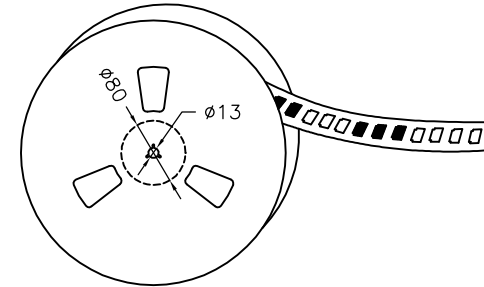
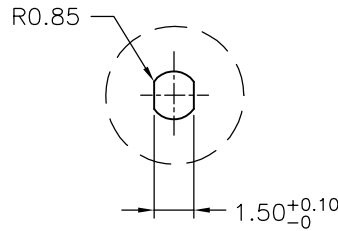

				UNIT	SCALE	SHEET	TITLE:
				mm		2 of 2	
		DRAWN BY		APPROVED BY		DRAW NO. : A1253WR-SF-XP	
		李勤		董正一			
		2005.12.08		2005.12.08			
		GENERAL TOLERANCE					
A1	REVISE	2007.01.03	X. X±0.25	ANGLE±			
A0	NEW RELEASE	2005.12.08	X. XX±0.15				
REV.	DESCRIPTION	DATE	X. XXX±0.05				