

PRODUCT CATALOG

SCHOTTKY POWER RECTIFIERS

3301 ELECTRONICS WAY, WEST PALM BEACH, FLORIDA 33407
 TEL: (407) 848-4311 FAX: (407) 863-5946

45V, 10A, 0.65V

SDS10045 JAA
 SDS10045 JAB
 SDS10045 JDA
 SDS10045 JFA
 SDS10045 JFB

FEATURES

- RUGGED PACKAGE
- HI-REL CONSTRUCTION
- CERAMIC EYELETS: JAA, JAB, JFA, JFB
- LEAD BENDING OPTIONS
- COPPER CORED 52 ALLOY PINS
- LOW IR LOSSES
- LOW THERMAL RESISTANCE
- OPTIONAL MIL-S-19500 OR MIL-STD-883 SCREENING

STANDARD BEND CONFIGURATIONS

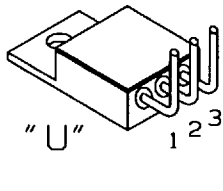
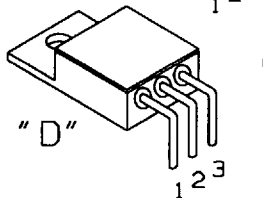
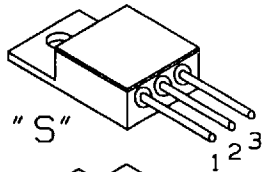

JAA
 JDA
 JFA

(CUSTOM BEND OPTIONS AVAILABLE)

STANDARD BEND CONFIGURATIONS

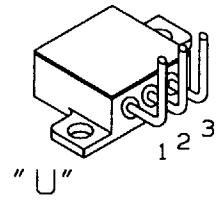
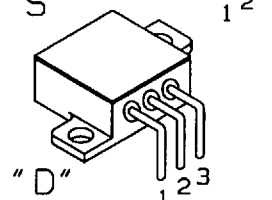
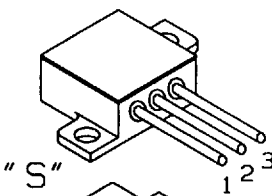

JAB
 JFB

(CUSTOM BEND OPTIONS AVAILABLE)

MAXIMUM RATINGS PER DIODE

PARAMETER	SYMBOL		UNITS
WORKING PEAK REVERSE VOLTAGE	VRRM	45	V
AVERAGE FORWARD CURRENT	IF(AV)	10	A
PEAK ONE CYCLE NON-REPETITIVE SURGE CURRENT	IFSM	260	A
PEAK REPETITIVE REVERSE CURRENT	IRRM	1.0	A
OPERATING JUNCTION TEMPERATURE RANGE	TJ	-65 TO +150	°C
STORAGE TEMPERATURE RANGE	Tstg	-65 TO +150	°C
THERMAL RESISTANCE JUNCTION TO CASE	RθJc	3.0	°C/W

ELECTRICAL CHARACTERISTICS Tc = 25°C (UNLESS OTHERWISE SPECIFIED)

PARAMETER	SYMBOL	TEST CONDITIONS		UNITS
MAX. PEAK FORWARD VOLTAGE (1)	VF	TJ=25°C IFM=10A	0.65	V
MAX. PEAK REVERSE CURRENT (1)	IRM	TJ=25°C VRWM=45V	6	mA
		TJ=125°C	25	
CAPACITANCE	Ct	Tc=25°C, VR=5VDC f=100KHZ TO 1 MHZ	1000	Pf

(1) PULSE TEST: PULSE WIDTH 300μS, DUTY CYCLE 2%

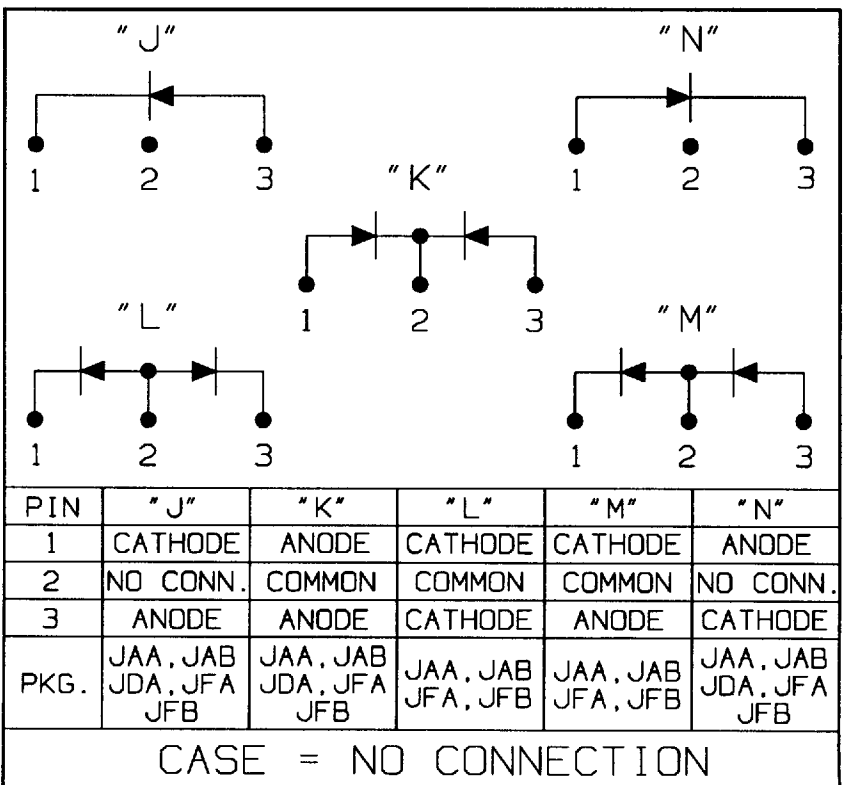

REV. 10/93