

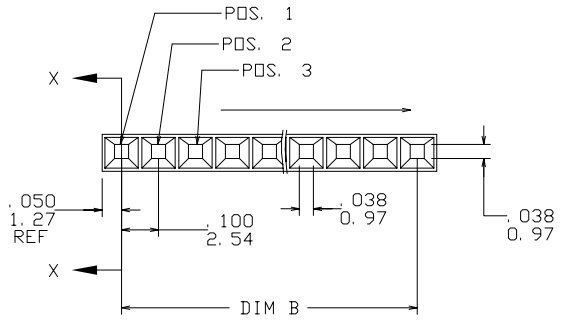

PRODUCT NO.  
SEE TABLE

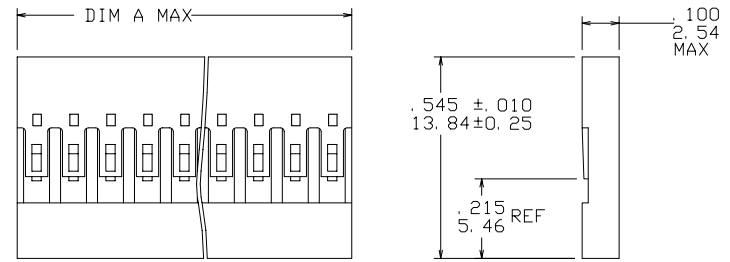
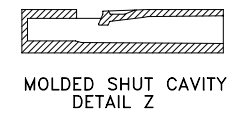
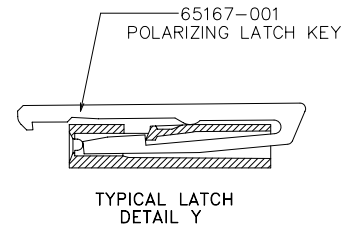
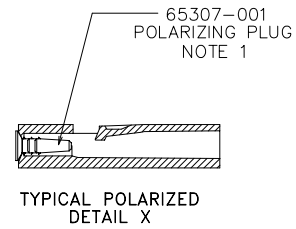

NOTES :

- ① POLARIZING KEY MUST BE COMPLETELY SEATED AGAINST THE ANGLES OF THE MALE PIN LEAD-IN.
2. PACKAGE PER BUS-14-022.
3. CSA CERTIFIED. MUST CONFORM TO BUS-22-265.
- ④ MOLDING MATERIAL : MODIFIED POLYPHENYLENE ETHER COLOR : BLACK. MEETING UL-94V-0
5. TO BE MATED WITH PIN .230/5.84 LONG.
6. THIS HOUSING IS INTENDED FOR USE WITH BERG MINI PV™ TERMINAL WITH 22-36 AWG WIRE.
7. FOR APPLICATION INFORMATION SEE TA-531.
- ⑧ PACKAGE EIGHT-DIGIT PART NUMBERS FOLLOWED BY A "B" IN BULK PACKAGING PER BUS-14-022.
- ⑨ ADD AN LF SUFFIX TO PART NUMBERS FOR PRODUCT THAT MEETS EUROPEAN UNION DIRECTIVES AND OTHER COUNTRY REGULATIONS AS DESCRIBED IN GS-22-008.
10. THIS PRODUCT IS NOT INTENDED TO BE EXPOSED TO MANUFACTURING SOLDER PROCESSES.

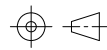

mat'l. code NOTE 4				tolerances unless otherwise specified		CUSTOMER COPY	 www.fciconnect.com
ltr	ecn no	dr	date	linear	.xx ±.01/.x±.3		
J	V31682	PDP	09/15/93		.xxx ±.005/.xx±.13	 INCH/MM	MINI LATCH HOUSING
K	V50128	GAH	03/21/95		.xxxx ±.0020/.xxx±.051		POL. S.R. .100/2.54 C.C.
L	V61656	HTB	11/07/96	angles	0° ±2°	product family	MINI LATCH
M	V71422	HTB	09/30/97	dr	S.ROYER 08/18/88	code	213
N	V90972	CGC	05/10/99	enr	J.SHUEY 08/18/88	size	dwg no
P	V03-1357	PJ	02/06/04	chr	J.SHUEY 08/18/88	scale	2:1
R	V05-0713	DAI	07/29/05	appd	J.SHUEY 08/18/88	A	65406
sheet index	revision	R	R				
	sheet	1	2				

cage code  
22526

Tous droits strictement reserves. Reproduction ou communication a des tiers interdite sous quelque forme que ce soit sans autorisation ecrite du proprietaire. Propriete de c FCI. Droits de reproduction FCI.

FCI

All rights strictly reserved. Reproduction or issue to third parties in any form whatever is not permitted without written authority from the proprietor. Property of FCI. Copyright FCI.

Tous droits strictement reserves. Reproduction ou communication a des tiers interdite sous quelque forme que ce soit sans autorisation ecrite du proprietaire. Propriete de c FCI. Droits de reproduction FCI.

All rights strictly reserved. Reproduction or issue to third parties in any form whatever is not permitted without written authority from the proprietor. Property of FCI. Copyright FCI.

PRODUCT NUMBER NOTE 9	NO. OF POSITIONS	LATCH OR POLARIZED POSITION	DIM A MAX.		DIM B		SPECIAL MARKINGS	COMMENTS	NOTE
			ENGLISH	METRIC	ENGLISH	METRIC			
65406-001	4	2	0.405	10.29	0.300	7.62		DETAIL X	
65406-002	4	3	0.405	10.29	0.300	7.62		DETAIL X	
65406-003	8	2	0.805	20.45	0.700	17.78		DETAIL X	
65406-004	8	7	0.805	20.45	0.700	17.78		DETAIL X	
65406-005	10	2	1.005	25.53	0.900	22.86		DETAIL X	
65406-006	10	9	1.005	25.53	0.900	22.86		DETAIL X	
65406-007	12	2	1.205	30.61	1.100	27.94		DETAIL X	
65406-008	12	11	1.205	30.61	1.100	27.94		DETAIL X	
65406-009	14	2	1.405	35.69	1.300	33.02		DETAIL X	
65406-010	16	2	1.605	40.77	1.500	38.10		DETAIL X	
65406-011	16	15	1.605	40.77	1.500	38.10		DETAIL X	
65406-012	20	2	2.005	50.93	1.900	48.26		DETAIL X	
65406-013	20	19	2.005	50.93	1.900	48.26		DETAIL X	
65406-014	24	2	2.405	61.09	2.300	58.42		DETAIL X	
65406-015	24	23	2.405	61.09	2.300	58.42		DETAIL X	
65406-016	5	2	0.505	12.83	0.400	10.16		DETAIL X	
65406-017	5	4	0.505	12.83	0.400	10.16		DETAIL X	
65406-018	4	2	0.405	10.29	0.300	7.62		DETAIL Y	
65406-019	4	3	0.405	10.29	0.300	7.62		DETAIL Z	8
65406-020	4	2	0.405	10.29	0.300	7.62		DETAIL Z	
65406-021	3	3	0.305	7.75	0.200	5.08		DETAIL Z	
65406-022	7	3	0.705	17.91	0.600	15.24		DETAIL Z	

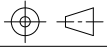
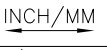
mat'l. code		-		tolerances unless otherwise specified		CUSTOMER COPY		 www.fciconnect.com	
ltr	ecn no	dr	date	linear	.XX ±.01/.X±.3	projection		title	
R					.XXX ±.005/.XX±.13			MINI LATCH HOUSING	
				angles	.XXXX ±.0020/.XXX±.051	INCH/MM		POL. S.R. .100/2.54 C.C.	
				dr	0° ±2°			product family	MINI LATCH
				enr	S.ROYER 08/18/88	scale	1:1	size	dwg no
				chr	T.HANNA 08/18/88	A		65406	
				appd	T.HANNA 08/18/88			sheet	
sheet index		revision sheet						2 of 2	