

1000 Series Miniature Slide Switches

Features/Benefits

- Variety of actuators and terminations
- Panel mount tabs available
- Epoxy terminal seal—compatible with bottom-wash cleaning
- RoHS compliant



Models Available

Typical Applications

- Test & measurement equipment
- Telecommunications
- Computer & peripherals

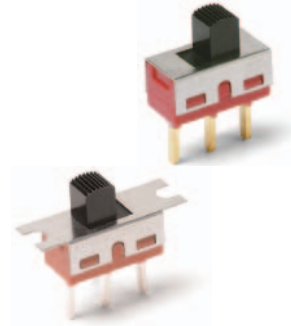

Specifications

CONTACT RATING: B contact material: 0.4 VA max. @ 20 V AC or DC max. Q contact material: 6 AMPS @ 120 V AC or 28 V DC, 3 AMPS @ 250 V AC. See page I-15 for additional ratings.

ELECTRICAL LIFE: 100,000 make-and-break cycles at full load on models with B, K or P contact material; 40,000 cycles on models with G, Q, L, M, S or R contact material.

CONTACT RESISTANCE: Below 10 m Ω typ. initial @ 2-4 V DC, 100 mA, for both silver and gold plated contacts.

INSULATION RESISTANCE: 10⁹ Ω min.

DIELECTRIC STRENGTH: 1,000 Vrms min. @ sea level.

OPERATING TEMPERATURE: -30°C to 65°C

SOLDERABILITY: Per MIL-STD-202F method 208D, or EIA RS-186E method 9 (1 hour steam aging).

Materials

CASE: diallyl phthalate (DAP), (UL 94V-0).

ACTUATOR: Nylon, black, standard.

HOUSING: Stainless steel.

SWITCH SUPPORT: Brass or steel, matte-tin plated.

END CONTACTS: B contact material: Copper alloy, with gold plate over nickel plate. Q contact material: Coin silver, silver plated. See page I-16 for additional contact materials.

CENTER CONTACT & ALL TERMINALS: B contact material: Copper alloy, with gold plate over nickel plate. Q contact material: Copper alloy, silver plated. See page I-16 for additional contact materials.

TERMINAL SEAL: Epoxy. Refer to Soldering and Cleaning in Technical Data chapter

NOTE: Any models supplied with Q, B, G, P, S or R contact material are RoHS compliant.

NOTE: Specifications and materials listed above are for switches with standard options.

For information on specific and custom switches, consult Customer Service Center.

Build-A-Switch

To order, simply select desired option from each category and place in the appropriate box. Available options are shown and described on pages I-12 through I-16. For additional options not shown in catalog, consult Customer Service Center. All models have epoxy terminal seal and are compatible with all “bottom-wash” PCB cleaning methods.

<p>Switch Function</p> <p>1101 SP On-None-On 1103 SP On-Off-On 1108 SP Mom-None-On 1201 DP On-None-On 1203 DP On-Off-On</p> <p>Mounting Style</p> <p>M2 PC mount without tabs M1 Panel mount with tabs</p> <p>Actuator</p> <p>S3 .200" high S1 .040" high S2 .140" high S4 .285" high S5 .370" high S6 .485" high T3 .200" high</p> <p>Terminations</p> <p>A Right angle, PC thru-hole C PC Thru-hole AV2 Vertical right angle, PC thru-hole Z Solder lug V3 V-bracket V4 V-bracket W .750" long, wire wrap Z3 Quick connect</p>	<p>Contact Material</p> <p>B Gold Q Silver G Gold over silver P Gold, matte-tin S Silver, matte-tin R Gold over silver, matte-tin</p> <p>Seal</p> <p>E Epoxy D No epoxy seal I Epoxy potted base</p> <p>Actuator Color</p> <p>2 Black 1 White 3 Red</p>
--	---



Dimensions are shown: Inches (mm)
Specifications and dimensions subject to change



Slide

1000 Series Miniature Slide Switches

SWITCH FUNCTION

NO. POLES	MODEL NO.	SWITCH FUNCTION			CONNECTED TERMINALS			SCHEMATIC
		POS. 1	POS. 2	POS. 3	POS. 1	POS. 2	POS. 3	
SP	1101	ON	NONE	ON	1-2	N/A	2-3	
	1103	ON	OFF	ON		OPEN		
	1108	MOM.	NONE	ON		N/A		
SPDT <p>Part number shown: 1101M2S3CQE2</p> <p>Terminal Nos. For Reference Only</p>								
DP	1201	ON	NONE	ON	2-1,5-4	OPEN	2-3,5-6	
	1203	ON	OFF	ON				
DPDT <p>Part number shown: 1201M2S3CQE2</p> <p>Terminal Nos. For Reference Only</p>								

MOM. = Momentary

All models with all options when ordered with G, Q, S or R contact material.

MOUNTING STYLE

M2 PC MOUNTING WITHOUT TABS

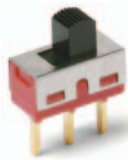

NOTE: Available with A, AV2, C, V3, V4, W terminations only.

M1 PANEL MOUNTING WITH TABS

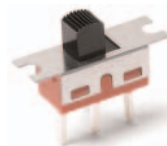

NOTE: Available with C, W, Z, Z3 terminations only. No mounting hardware supplied.

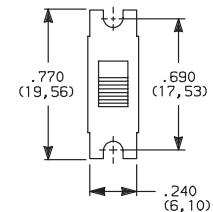

PANEL MOUNTING

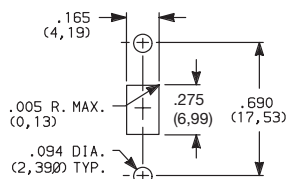

All actuators except T3.
Single pole

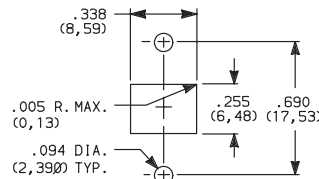

For T3 actuator only.
Double pole



Dimensions are shown: Inch (mm)
Specifications and dimensions subject to change



1000 Series Miniature Slide Switches

ACTUATOR

S3 .200" HIGH

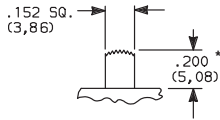

S2 .140" HIGH

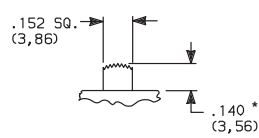

110X models only.

S1 .040" HIGH

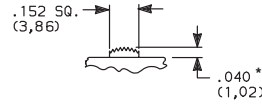

120X models only.

S4 .285" HIGH

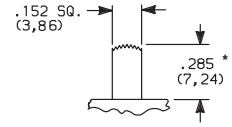

S5 .370" HIGH

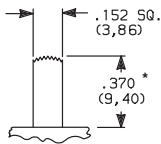

S6 .485" HIGH

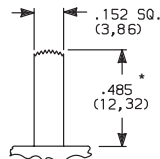

T3 .200" HIGH

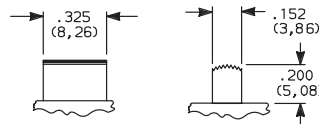

120X models only.

OPTION CODE	ACTUATOR COLOR
2	BLACK
1	WHITE
3	RED
7	BLUE
9	GRAY

Other colors available, consult Customer Service Center.

* Subtract .014 (0,36) from actuator height, all models with A, AV2 - 2 pole, V3, V4 terminations.

TERMINATIONS

Z SOLDER LUG

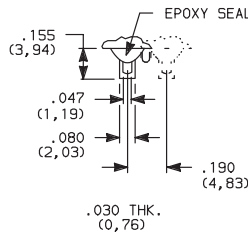

Not available with P, S or R contact materials.

SPDT & DPDT

C PC THRU-HOLE

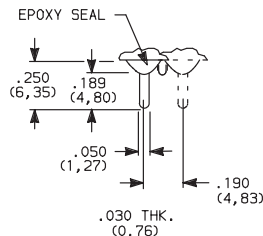

PC MOUNTING

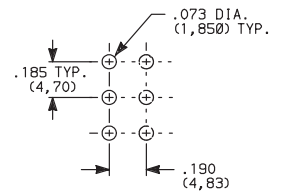

SPDT & DPDT

Z3 QUICK CONNECT

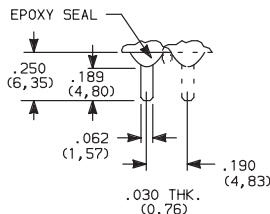

Not available with P, S or R contact materials. Mating quick connector available; order part number 530100000, page I-16.

SPDT & DPDT

W WIRE WRAP

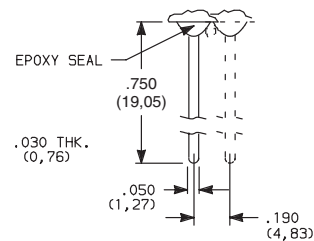

SPDT & DPDT

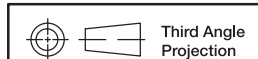

Dimensions are shown: Inches (mm)
Specifications and dimensions subject to change



Slide

1000 Series Miniature Slide Switches

TERMINATIONS

A RIGHT ANGLE, PC THRU-HOLE



1101M2S3ABE2
Horizontal Actuation
SPDT

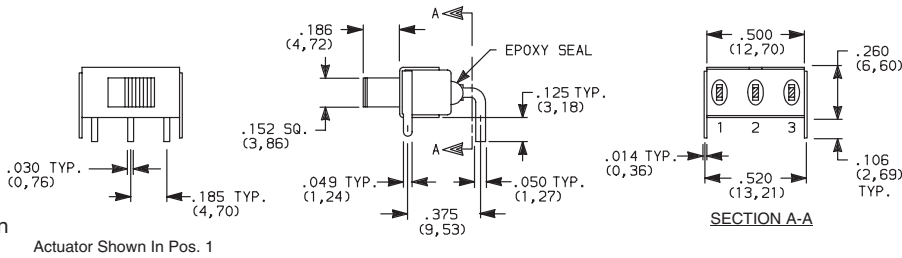

Not available with M1 mounting style, I seal option.
Terminal bend radii and lead-in manufacturing option.

A RIGHT ANGLE, PC THRU-HOLE

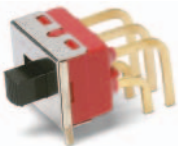

1201M2S3ABE2
Horizontal Actuation
DPDT

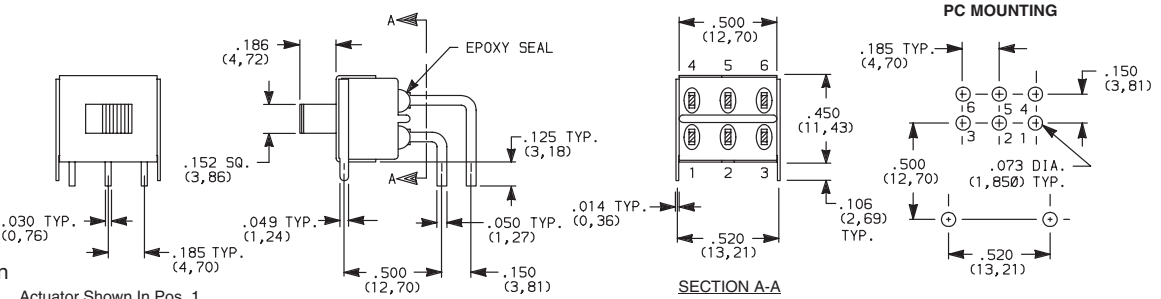

Not available with M1 mounting style, I seal option.
Terminal bend radii and lead-in manufacturing option.

AV2 VERTICAL RIGHT ANGLE, PC THRU-HOLE, .150" PITCH



1101M2S3AV2BE2
Vertical Actuation
SPDT

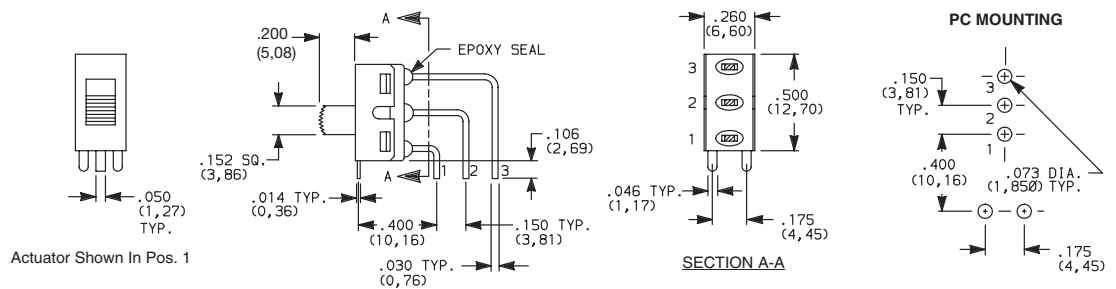

Not available with M1 mounting style, I seal option.
Terminal bend radii and lead-in manufacturing option.



Third Angle
Projection

Dimensions are shown: Inch (mm)
Specifications and dimensions subject to change



1000 Series Miniature Slide Switches

TERMINATIONS

AV2 VERTICAL RIGHT ANGLE, PC THRU-HOLE,
.150" PITCH

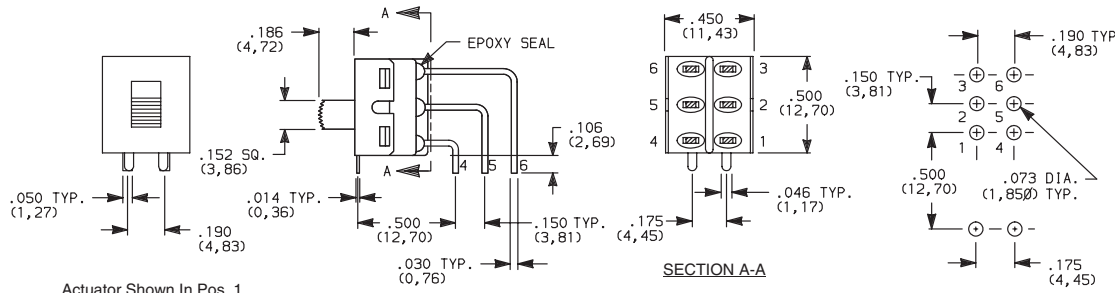

Not available with M1 mounting style, I seal option.
Terminal bend radii and lead-in manufacturing option.

V3, V4 VERTICAL MOUNT,
V-BRACKET

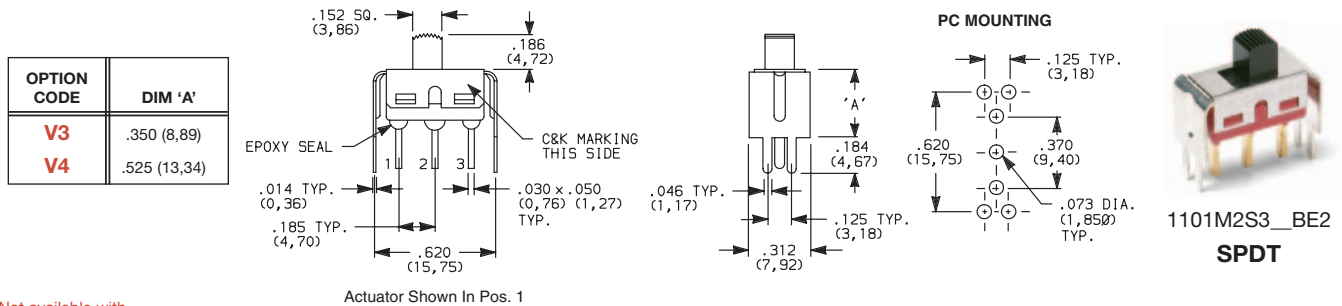

Not available with M1 mounting style and I seal.

V3, V4 VERTICAL MOUNT,
V-BRACKET

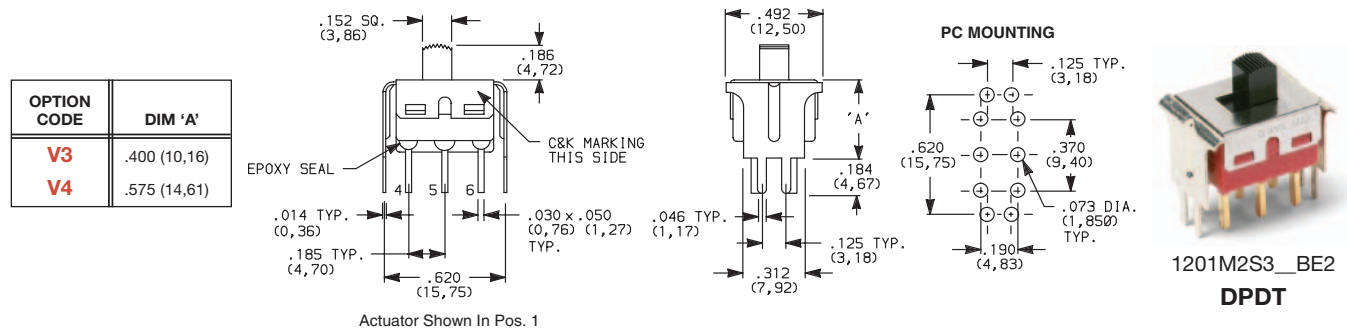

Not available with M1 mounting style and I seal.



Dimensions are shown: Inches (mm)
Specifications and dimensions subject to change

1000 Series Miniature Slide Switches

CONTACT MATERIAL

OPTION CODE	CONTACT MATERIAL	TERMINAL PLATING	RATINGS	
B	GOLD ¹	GOLD ³	LOW LEVEL/ DRY CIRCUIT	0.4 VA MAX. @ 20 V AC OR DC MAX.
P		MATTE-TIN ⁶		
Q	SILVER ^{4,5}	GOLD ³	POWER	6 AMPS @ 120 V AC OR 28 V DC; 3 AMPS @ 250 V AC.
S		MATTE-TIN ⁶		
G	GOLD OVER SILVER ^{2,3}	GOLD ³	LOW LEVEL/DRY CIRCUIT OR POWER	0.4 VA MAX @ 20 V AC OR DC MAX OR 6 AMPS @ 120 V AC OR 0.4 MAX. 28 V DC; 3 AMPS @ 250 V AC.
R		MATTE-TIN ⁶		

* Note: See Technical Data section of this catalog for RoHS compliant and compatible definitions and specifications.

¹ CONTACTS & TERMINALS: Copper alloy, with gold plate over nickel plate.

² END CONTACTS: Coin silver, with gold plate over nickel plate.

³ CENTER CONTACTS & ALL TERMINALS: Copper alloy, with gold plate over nickel plate.

⁴ END CONTACTS: Coin silver, silver plated.

⁵ CENTER CONTACT & ALL TERMINALS: Copper alloy, silver plated.

⁶ TERMINALS: Copper alloy, with matte-tin over nickel plate.

All models **CALUS** with all options when ordered with G, Q, S or R contact material.

B contact material standard with all terminations except C, Z, Z3.

Q contact material standard with C, Z, Z3 terminations.

P, S or R contact materials not available with Z, Z3 terminations.

NOTE: Any models supplied with Q, B, G, P, S or R contact material are RoHS compliant.

SEAL

E EPOXY SEAL

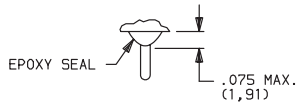

D NO EPOXY SEAL

I EPOXY POTTED BASE

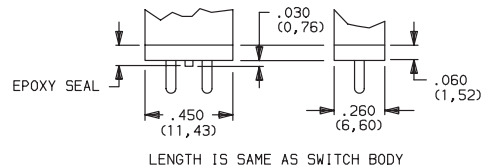

NOTE: Available with C, W, W3, Z, Z3 terminations only.

AVAILABLE HARDWARE

Fits Z3 Termination
female connector



PART NO.

530100000

Available in loose pieces.



Third Angle
Projection

Dimensions are shown: Inch (mm)

Specifications and dimensions subject to change

C&K