

## 54F/74F827 • 74F828 10-Bit Buffers/Line Drivers

### General Description

The 'F827 and 'F828 10-bit bus buffers provide high performance bus interface buffering for wide data/address paths or buses carrying parity. The 10-bit buffers have NOR output enables for maximum control flexibility.

The 'F827 and 'F828 are functionally- and pin-compatible to AMD's Am29827 and Am29828. The 'F828 is an inverting version of the 'F827.

### Features

- TRI-STATE® output
- 'F828 is inverting
- Direct replacement for AMD's Am29827 and Am29828

### Ordering Code: See Section 11

Commercial	Military	Package Number	Package Description
74F827SPC		N24C	24-Lead (0.300" Wide) Molded Dual-In-Line
	54F827SDM (Note 2)	J24F	24-Lead (0.300" Wide) Ceramic Dual-In-Line
74F827SC (Note 1)		M24B	24-Lead (0.300" Wide) Molded Small Outline, JEDEC
	54F827FM (Note 2)	W24C	24-Lead Cerpack
	54F827LM (Note 2)	E28A	24-Lead Ceramic Leadless Chip Carrier, Type C
74F828SPC		N24C	24-Lead (0.300" Wide) Molded Dual-In-Line
74F828SC (Note 1)		M24B	24-Lead (0.300" Wide) Molded Small Outline, JEDEC

**Note 1:** Devices also available in 13" reel. Use suffix = SCX.

**Note 2:** Military grade device with environmental and burn-in processing. Use suffix = SDMQB, FMOB and LMQB.

### Connection Diagrams

Pin Assignment for  
DIP, Flatpak and SOIC

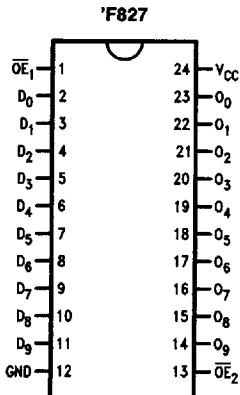

TL/F/9598-1

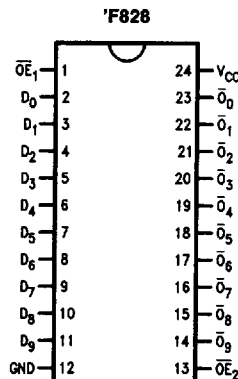

TL/F/9598-8

Pin Assignment  
for LCC

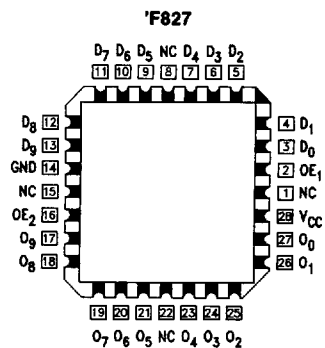

TL/F/9598-2

# Logic Symbols

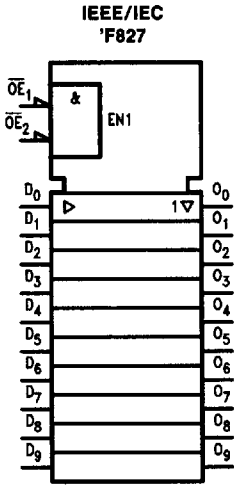

TL/F/9598-6

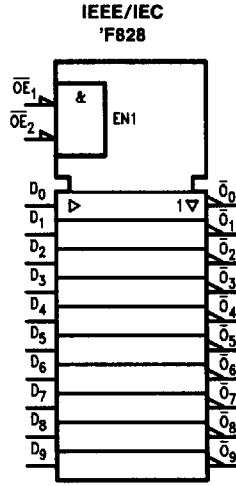

TL/F/9598-7

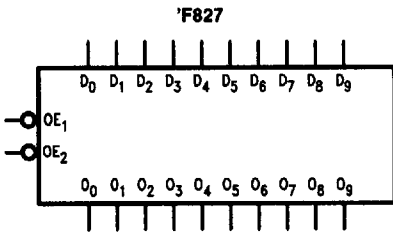

TL/F/9598-3

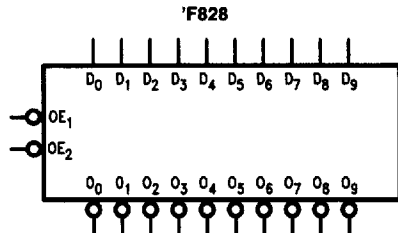

TL/F/9598-10

**Unit Loading/Fan Out:** See Section 2 for U.L. definitions

Pin Names	Description	54F/74F	
		U.L. HIGH/LOW	Input $I_{IH}/I_{IL}$ Output $I_{OH}/I_{OL}$
$\overline{OE}_1, \overline{OE}_2$	Output Enable Input	1.0/1.0	20 $\mu$ A/ -0.6 mA
$D_0-D_7$	Data Inputs	1.0/1.0	20 $\mu$ A/ -0.6 mA
$O_0-O_7$	Data Outputs, TRI-STATE	600/106.6 (80)	-12 mA/64 mA (48 mA)

**Functional Description**

The 'F827 and 'F828 are line drivers designed to be employed as memory address drivers, clock drivers and bus-oriented transmitters/receivers which provide improved PC board density. The devices have TRI-STATE outputs controlled by the Output Enable ( $\overline{OE}$ ) pins. The outputs can sink 64 mA (48 mA mil) and source 15 mA. Input clamp diodes limit high-speed termination effects.

**Function Table**

Inputs		Outputs		Function
$\overline{OE}$	$D_n$	$O_n$		
		'F827	'F828	
L	H	H	L	Transparent
L	L	L	H	Transparent
H	X	Z	Z	High Z

H = HIGH Voltage level  
 L = LOW Voltage Level  
 Z = High Impedance  
 X = Immaterial

**Logic Diagrams**

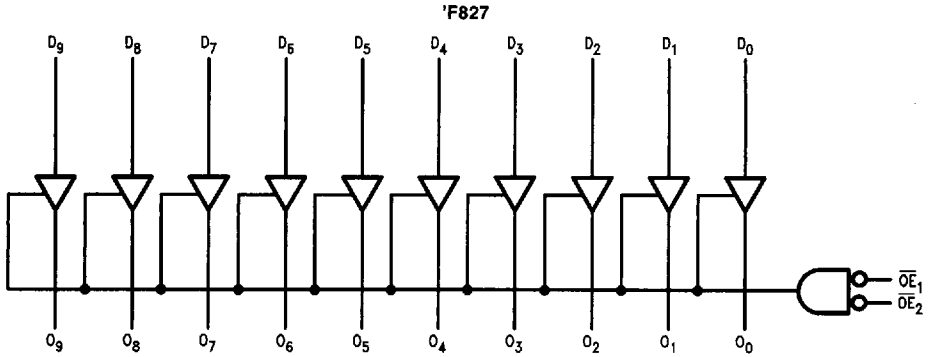

TL/F/9598-4

Please note that this diagram is provided only for the understanding of logic operations and should not be used to estimate propagation delays.

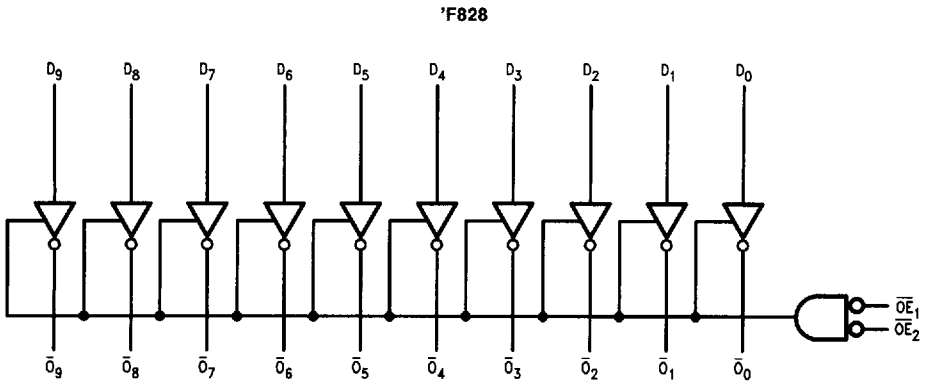

TL/F/9598-11

Please note that this diagram is provided only for the understanding of logic operations and should not be used to estimate propagation delays.

**Absolute Maximum Ratings** (Note 1)

If Military/Aerospace specified devices are required, please contact the National Semiconductor Sales Office/Distributors for availability and specifications.

Storage Temperature	-65°C to +150°C
Ambient Temperature under Bias	-55°C to +125°C
Junction Temperature under Bias	-55°C to +175°C
Plastic	-55°C to +150°C
V <sub>CC</sub> Pin Potential to Ground Pin	-0.5V to +7.0V
Input Voltage (Note 2)	-0.5V to +7.0V
Input Current (Note 2)	-30 mA to +5.0 mA
Voltage Applied to Output in HIGH State (with V <sub>CC</sub> = 0V)	
Standard Output	-0.5V to V <sub>CC</sub>
TRI-STATE Output	-0.5V to +5.5V

Current Applied to Output in LOW State (Max) twice the rated I<sub>OL</sub> (mA)

**Note 1:** Absolute maximum ratings are values beyond which the device may be damaged or have its useful life impaired. Functional operation under these conditions is not implied.

**Note 2:** Either voltage limit or current limit is sufficient to protect inputs.

**Recommended Operating Conditions**

Free Air Ambient Temperature	
Military	-55°C to +125°C
Commercial	0°C to +70°C
Supply Voltage	
Military	+4.5V to +5.5V
Commercial	+4.5V to +5.5V

**DC Electrical Characteristics**

Symbol	Parameter		54F/74F			Units	V <sub>CC</sub>	Conditions
			Min	Typ	Max			
V <sub>IH</sub>	Input HIGH Voltage		2.0			V		Recognized as a HIGH Signal
V <sub>IL</sub>	Input LOW Voltage					V		Recognized as a LOW Signal
V <sub>CD</sub>	Input Clamp Diode Voltage					V	Min	I <sub>IN</sub> = -18 mA
V <sub>OH</sub>	Output HIGH Voltage	54F 10% V <sub>CC</sub>	2.4			V	Min	I <sub>OH</sub> = -3 mA
		54F 10% V <sub>CC</sub>	2.0					I <sub>OH</sub> = -12 mA
		74F 10% V <sub>CC</sub>	2.4					I <sub>OH</sub> = -3 mA
		74F 10% V <sub>CC</sub>	2.0					I <sub>OH</sub> = -15 mA
		74F 5% V <sub>CC</sub>	2.7					I <sub>OH</sub> = -3 mA
V <sub>OL</sub>	Output LOW Voltage	54F 10% V <sub>CC</sub>				V	Min	I <sub>OL</sub> = 48 mA
		74F 10% V <sub>CC</sub>						I <sub>OL</sub> = 64 mA
I <sub>IH</sub>	Input HIGH Current	54F	20.0			μA	Max	V <sub>IN</sub> = 2.7V
		74F	5.0					
I <sub>BVI</sub>	Input HIGH Current Breakdown Test	54F	100			μA	Max	V <sub>IN</sub> = 7.0V
		74F	7.0					
I <sub>CEX</sub>	Output HIGH Leakage Current	54F	250			μA	Max	V <sub>OUT</sub> = V <sub>CC</sub>
		74F	50					
V <sub>ID</sub>	Input Leakage Test	74F	4.75			V	0.0	I <sub>ID</sub> = 1.9 μA All Other Pins Grounded
I <sub>OD</sub>	Output Leakage Circuit Current	74F	3.75			μA	0.0	V <sub>IOD</sub> = 150 mV All Other Pins Grounded
I <sub>IL</sub>	Input LOW Current		-0.6			mA	Max	V <sub>IN</sub> = 0.5V
I <sub>OZH</sub>	Output Leakage Current		50			μA	Max	V <sub>OUT</sub> = 2.7V
I <sub>OZL</sub>	Output Leakage Current		-50			μA	Max	V <sub>OUT</sub> = 0.5V
I <sub>OS</sub>	Output Short-Circuit Current		-100	-225		mA	Max	V <sub>OUT</sub> = 0V

**DC Electrical Characteristics** (Continued)

Symbol	Parameter	54F/74F			Units	V <sub>CC</sub>	Conditions
		Min	Typ	Max			
I <sub>ZZ</sub>	Bus Drainage Test			500	μA	0.0V	V <sub>OUT</sub> = 5.25V
I <sub>CCH</sub>	Power Supply Current ('F827)		30	45	mA	Max	V <sub>O</sub> = HIGH
I <sub>CCL</sub>	Power Supply Current ('F827)		60	90	mA	Max	V <sub>O</sub> = LOW
I <sub>CCZ</sub>	Power Supply Current ('F827)		40	60	mA	Max	V <sub>O</sub> = HIGH Z
I <sub>CCH</sub>	Power Supply Current ('F828)		14	20	mA	Max	V <sub>O</sub> = HIGH
I <sub>CCL</sub>	Power Supply Current ('F828)		56	85	mA	Max	V <sub>O</sub> = LOW
I <sub>CCZ</sub>	Power Supply Current ('F828)		35	50	mA	Max	V <sub>O</sub> = HIGH Z

**AC Electrical Characteristics:** See Section 2 for Waveforms and Load Configurations

Symbol	Parameter	74F			54F		74F		Units	Fig. No.
		T <sub>A</sub> = +25°C V <sub>CC</sub> = +5.0V C <sub>L</sub> = 50 pF			T <sub>A</sub> , V <sub>CC</sub> = Mil C <sub>L</sub> = 50 pF		T <sub>A</sub> , V <sub>CC</sub> = Com C <sub>L</sub> = 50 pF			
		Min	Typ	Max	Min	Max	Min	Max		
t <sub>PLH</sub>	Propagation Delay	1.0	3.0	5.5	1.0	7.5	1.0	6.5	ns	2-3
t <sub>PHL</sub>	Data to Output ('F827)	1.5	3.3	5.5	1.5	7.0	1.5	6.0		
t <sub>PLH</sub>	Propagation Delay	1.0	3.0	5.0			1.0	5.5	ns	2-3
t <sub>PHL</sub>	Data to Output ('F828)	1.0	2.0	4.0			1.0	4.0		
t <sub>PZH</sub>	Output Enable Time	3.0	5.7	9.0	2.5	10.0	2.5	9.5	ns	2-5
t <sub>PZL</sub>	$\overline{OE}$ to O <sub>n</sub>	3.5	6.8	11.5	3.0	12.5	3.0	12.0		
t <sub>PHZ</sub>	Output Disable Time	1.5	3.3	8.0	1.5	9.0	1.5	8.5	ns	2-5
t <sub>PLZ</sub>	$\overline{OE}$ to O <sub>n</sub>	1.0	3.5	8.0	1.0	9.0	1.0	8.5		