

8K x 8 Static RAM

Features

- High speed
 - 15 ns
- Fast t_{DOE}
- Low active power
 - 715 mW
- Low standby power
 - 85 mW
- CMOS for optimum speed/power
- Easy memory expansion with \overline{CE}_1 , CE_2 and \overline{OE} features
- TTL-compatible inputs and outputs
- Automatic power-down when deselected
- Available in non Pb-free 28-pin (300-Mil) Molded SOJ, 28-pin (300-Mil) Molded SOIC and both Pb-free and non Pb-free in 28-pin (300-Mil) Molded DIP

Functional Description^[1]

The CY7C185 is a high-performance CMOS static RAM organized as 8192 words by 8 bits. Easy memory expansion is provided by an active LOW chip enable (\overline{CE}_1), an active HIGH chip enable (CE_2), and active LOW output enable (\overline{OE}) and tri-state drivers. This device has an automatic power-down feature (\overline{CE}_1 or CE_2), reducing the power consumption by 70% when deselected. The CY7C185 is in a standard 300-mil-wide DIP, SOJ, or SOIC package.

An active LOW write enable signal (\overline{WE}) controls the writing/reading operation of the memory. When \overline{CE}_1 and \overline{WE} inputs are both LOW and CE_2 is HIGH, data on the eight data input/output pins (I/O_0 through I/O_7) is written into the memory location addressed by the address present on the address pins (A_0 through A_{12}). Reading the device is accomplished by selecting the device and enabling the outputs, \overline{CE}_1 and \overline{OE} active LOW, CE_2 active HIGH, while \overline{WE} remains inactive or HIGH. Under these conditions, the contents of the location addressed by the information on address pins are present on the eight data input/output pins.

The input/output pins remain in a high-impedance state unless the chip is selected, outputs are enabled, and write enable (\overline{WE}) is HIGH. A die coat is used to insure alpha immunity.

Logic Block Diagram

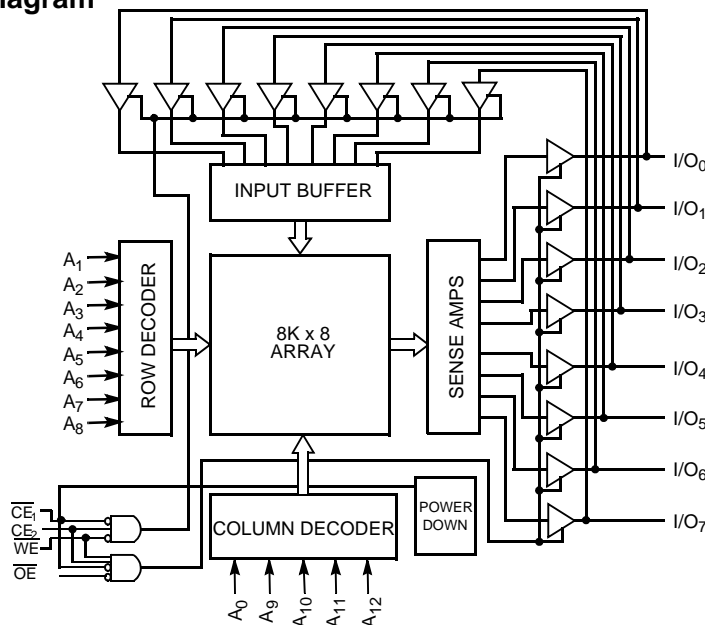

Pin Configurations

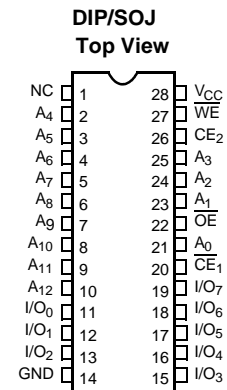

Selection Guide

	-15	-20	-25	-35
Maximum Access Time (ns)	15	20	25	35
Maximum Operating Current (mA)	130	110	100	100
Maximum CMOS Standby Current (mA)	15	15	15	15

Notes:

1. For guidelines on SRAM system design, please refer to the 'System Design Guidelines' Cypress application note, available on the internet at www.cypress.com.

Maximum Ratings

(Above which the useful life may be impaired. For user guidelines, not tested.)

Storage Temperature	-65°C to +150°C
Ambient Temperature with Power Applied.....	-55°C to +125°C
Supply Voltage to Ground Potential	-0.5V to +7.0V
DC Voltage Applied to Outputs in High Z State ^[2]	-0.5V to +7.0V
DC Input Voltage ^[2]	-0.5V to +7.0V

Output Current into Outputs (LOW).....	20 mA
Static Discharge Voltage.....	>2001V (per MIL-STD-883, Method 3015)
Latch-Up Current.....	>200 mA

Operating Range

Range	Ambient Temperature	V _{CC}
Commercial	0°C to +70°C	5V ± 10%
Industrial	-40°C to +85°C	5V ± 10%

Electrical Characteristics Over the Operating Range

Parameter	Description	Test Conditions	-15		-20		-25, -35		Unit
			Min.	Max.	Min.	Max.	Min.	Max.	
V _{OH}	Output HIGH Voltage	V _{CC} = Min., I _{OH} = -4.0 mA	2.4		2.4		2.4		V
V _{OL}	Output LOW Voltage	V _{CC} = Min., I _{OL} = 8.0 mA		0.4		0.4		0.4	V
V _{IH}	Input HIGH Voltage		2.2	V _{CC} + 0.3V	2.2	V _{CC} + 0.3V	2.2	V _{CC} + 0.3V	V
V _{IL}	Input LOW Voltage ^[2]		-0.5	0.8	-0.5	0.8	-0.5	0.8	V
I _{IX}	Input Leakage Current	GND ≤ V _I ≤ V _{CC}	-5	+5	-5	+5	-5	+5	μA
I _{OZ}	Output Leakage Current	GND ≤ V _I ≤ V _{CC} , Output Disabled	-5	+5	-5	+5	-5	+5	μA
I _{CC}	V _{CC} Operating Supply Current	V _{CC} = Max., I _{OUT} = 0 mA		130		110		100	mA
I _{SB1}	Automatic Power-Down Current	Max. V _{CC} , CE ₁ ≥ V _{IH} or CE ₂ ≤ V _{IL} , Min. Duty Cycle = 100%		40		20		20	mA
I _{SB2}	Automatic Power-Down Current	Max. V _{CC} , CE ₁ ≥ V _{CC} - 0.3V, or CE ₂ ≤ 0.3V, V _{IN} ≥ V _{CC} - 0.3V or V _{IN} ≤ 0.3V		15		15		15	mA

Capacitance^[3]

Parameter	Description	Test Conditions	Max.	Unit
C _{IN}	Input Capacitance	T _A = 25°C, f = 1 MHz, V _{CC} = 5.0V	7	pF
C _{OUT}	Output Capacitance		7	pF

Notes:

- Minimum voltage is equal to -3.0V for pulse durations less than 30 ns.
- Tested initially and after any design or process changes that may affect these parameters.

AC Test Loads and Waveforms

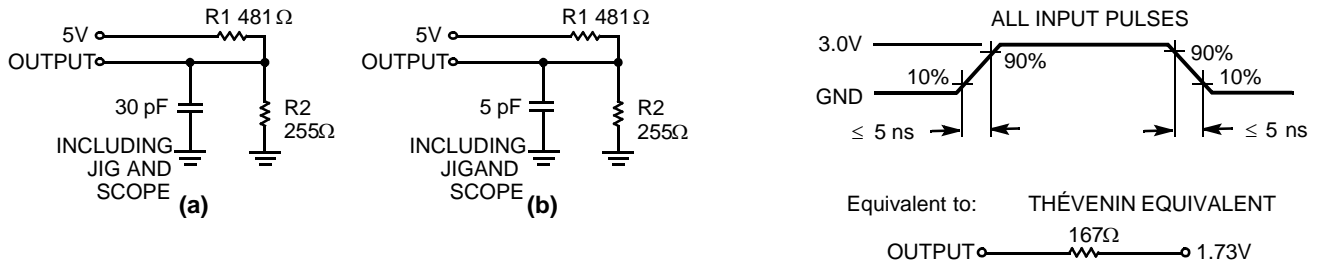

Switching Characteristics Over the Operating Range^[4]

Parameter	Description	-15		-20		-25		-35		Unit
		Min.	Max.	Min.	Max.	Min.	Max.	Min.	Max.	
Read Cycle										
t_{RC}	Read Cycle Time	15		20		25		35		ns
t_{AA}	Address to Data Valid		15		20		25		35	ns
t_{OHA}	Data Hold from Address Change	3		5		5		5		ns
t_{ACE1}	\overline{CE}_1 LOW to Data Valid		15		20		25		35	ns
t_{ACE2}	CE_2 HIGH to Data Valid		15		20		25		35	ns
t_{DOE}	\overline{OE} LOW to Data Valid		8		9		12		15	ns
t_{LZOE}	\overline{OE} LOW to Low Z	3		3		3		3		ns
t_{HZOE}	\overline{OE} HIGH to High Z ^[5]		7		8		10		10	ns
t_{LZCE1}	\overline{CE}_1 LOW to Low Z ^[6]	3		5		5		5		ns
t_{LZCE2}	CE_2 HIGH to Low Z	3		3		3		3		ns
t_{HZCE}	\overline{CE}_1 HIGH to High Z ^[5, 6] CE_2 LOW to High Z		7		8		10		10	ns
t_{PU}	\overline{CE}_1 LOW to Power-Up CE_2 to HIGH to Power-Up	0		0		0		0		ns
t_{PD}	\overline{CE}_1 HIGH to Power-Down CE_2 LOW to Power-Down		15		20		20		20	ns
Write Cycle^[7]										
t_{WC}	Write Cycle Time	15		20		25		35		ns
t_{SCE1}	\overline{CE}_1 LOW to Write End	12		15		20		20		ns
t_{SCE2}	CE_2 HIGH to Write End	12		15		20		20		ns
t_{AW}	Address Set-up to Write End	12		15		20		25		ns
t_{HA}	Address Hold from Write End	0		0		0		0		ns
t_{SA}	Address Set-up to Write Start	0		0		0		0		ns
t_{PWE}	\overline{WE} Pulse Width	12		15		15		20		ns
t_{SD}	Data Set-up to Write End	8		10		10		12		ns
t_{HD}	Data Hold from Write End	0		0		0		0		ns
t_{HZWE}	\overline{WE} LOW to High Z ^[5]		7		7		7		8	ns
t_{LZWE}	\overline{WE} HIGH to Low Z	3		5		5		5		ns

Notes:

- Test conditions assume signal transition time of 5 ns or less, timing reference levels of 1.5V, input pulse levels of 0 to 3.0V, and output loading of the specified I_{OL}/I_{OH} and 30-pF load capacitance.
- t_{HZOE} , t_{HZCE} , and t_{HZWE} are specified with $C_L = 5$ pF as in part (b) of AC Test Loads. Transition is measured ± 500 mV from steady state voltage.
- At any given temperature and voltage condition, t_{HZCE} is less than t_{LZCE1} and t_{LZCE2} for any given device.
- The internal write time of the memory is defined by the overlap of \overline{CE}_1 LOW, CE_2 HIGH, and \overline{WE} LOW. All 3 signals must be active to initiate a write and either signal can terminate a write by going HIGH. The data input set-up and hold timing should be referenced to the rising edge of the signal that terminates the write.

Switching Waveforms

Read Cycle No.1^[8,9]

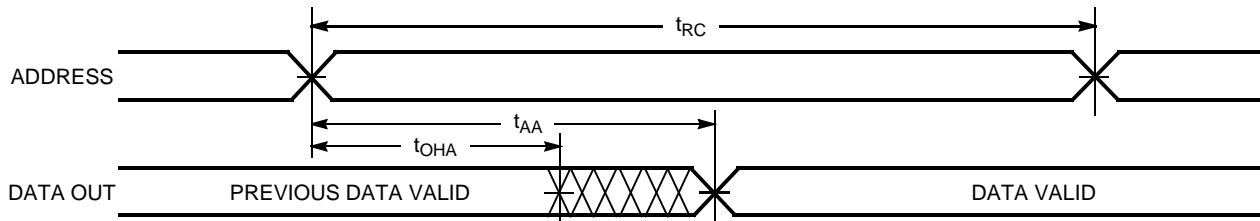

Read Cycle No.2^[10,11]

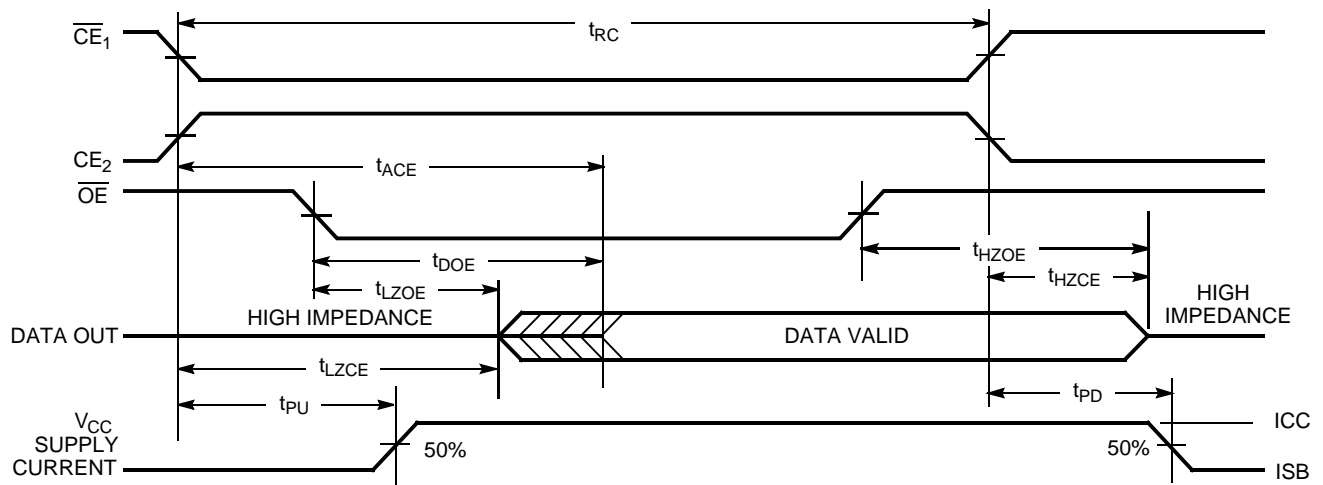

Notes:

- 8. Device is continuously selected. \overline{OE} , $\overline{CE}_1 = V_{IL}$, $CE_2 = V_{IH}$.
- 9. \overline{WE} is HIGH for read cycle.
- 10. Data I/O is High Z if $\overline{OE} = V_{IH}$, $\overline{CE}_1 = V_{IH}$, $\overline{WE} = V_{IL}$, or $CE_2 = V_{IL}$.
- 11. The internal write time of the memory is defined by the overlap of \overline{CE}_1 LOW, CE_2 HIGH and \overline{WE} LOW. \overline{CE}_1 and \overline{WE} must be LOW and CE_2 must be HIGH to initiate write. A write can be terminated by \overline{CE}_1 or \overline{WE} going HIGH or CE_2 going LOW. The data input set-up and hold timing should be referenced to the rising edge of the signal that terminates the write.

Switching Waveforms (continued)

Write Cycle No. 1 (\overline{WE} Controlled)^[9,11]

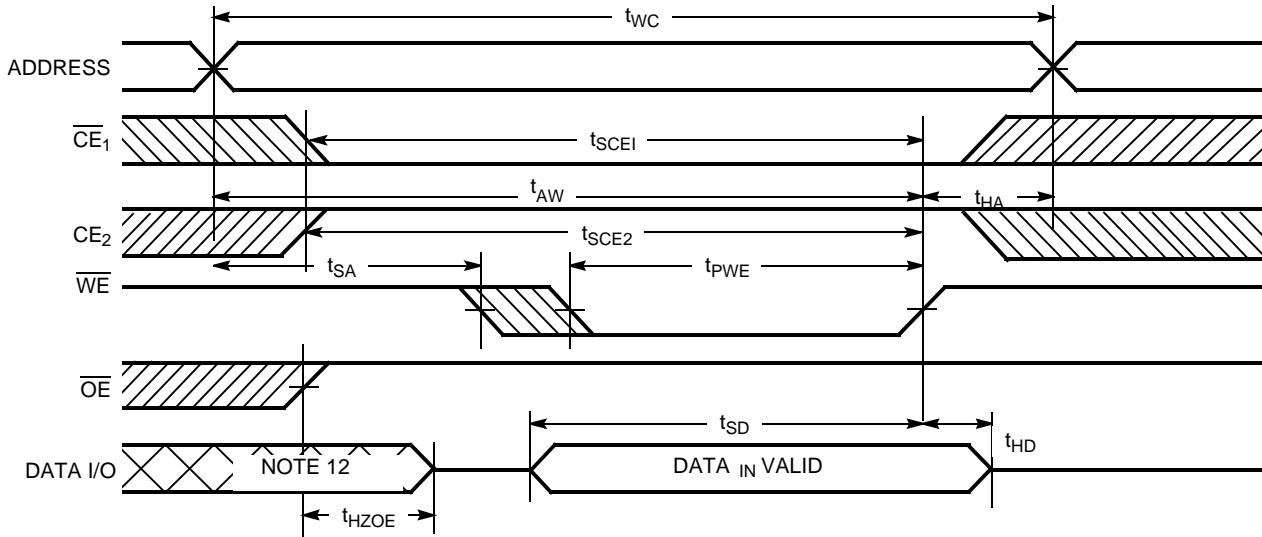

Write Cycle No. 2 (\overline{CE} Controlled)^[11,12,13]

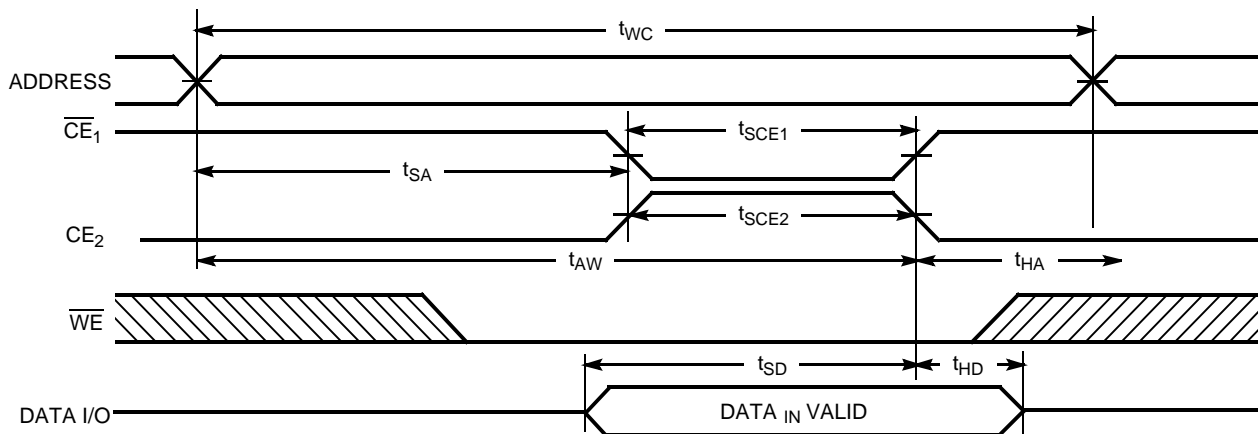

Notes:

- 12. During this period, the I/Os are in the output state and input signals should not be applied.
- 13. The minimum write cycle time for write cycle #3 (\overline{WE} controlled, \overline{OE} LOW) is the sum of t_{HZWE} and t_{SD} .

Switching Waveforms (continued)

Write Cycle No. 3 (\overline{WE} Controlled, \overline{OE} LOW)^[11,12,13,14]

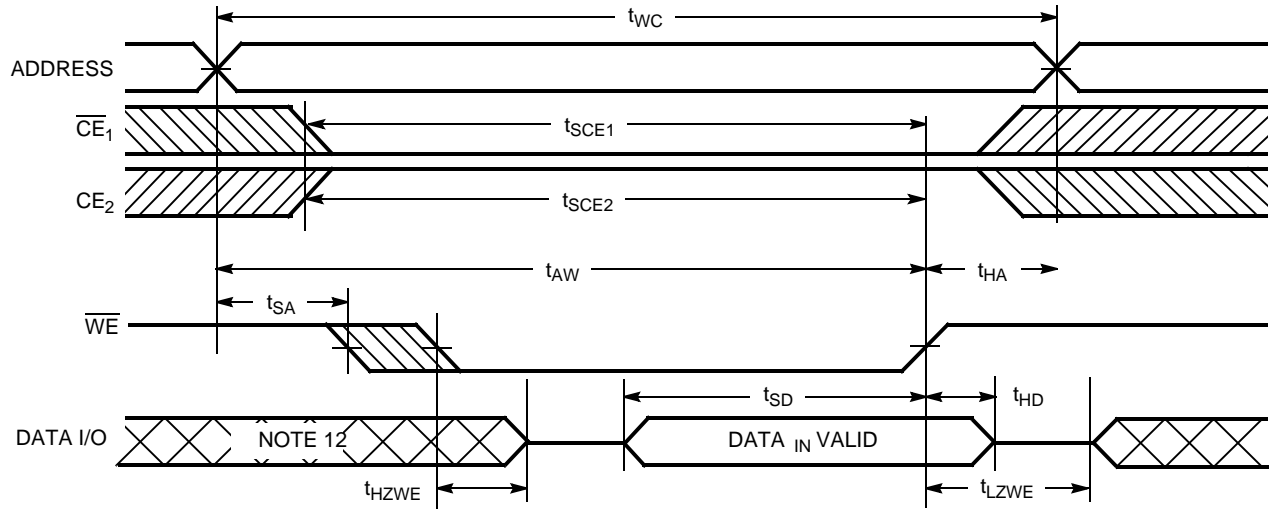

Note:

14. If \overline{CE}_1 goes HIGH or \overline{CE}_2 goes LOW simultaneously with \overline{WE} HIGH, the output remains in a high-impedance state.

Typical DC and AC Characteristics

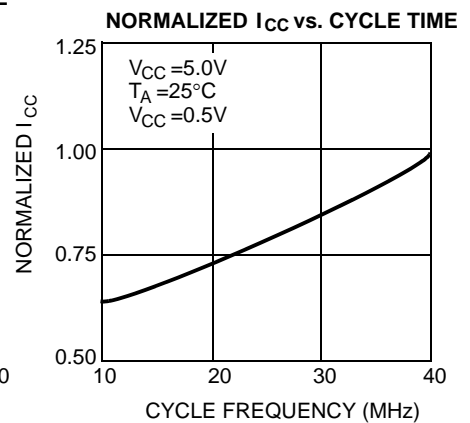
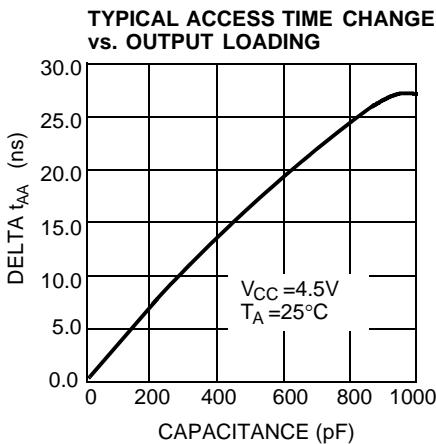
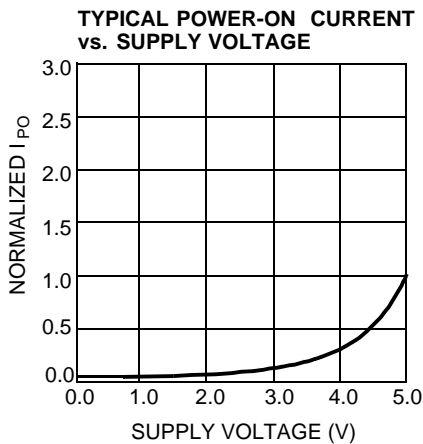
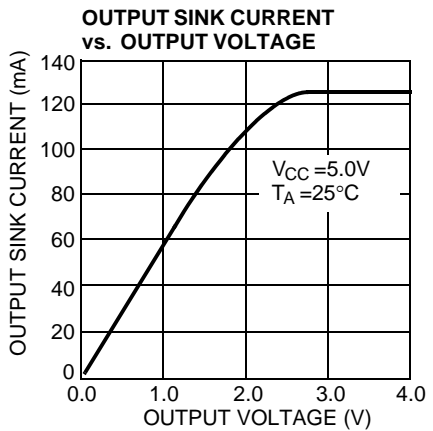
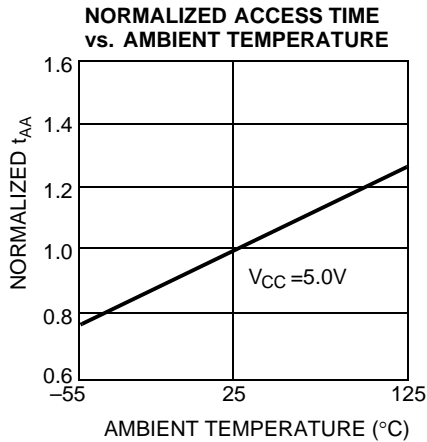
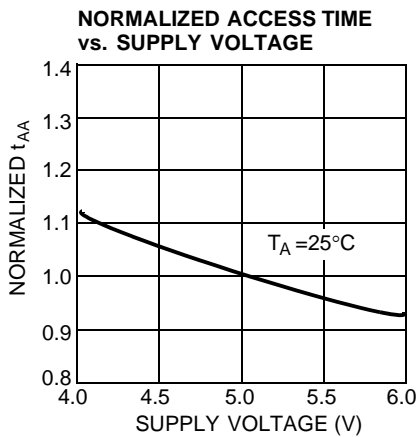
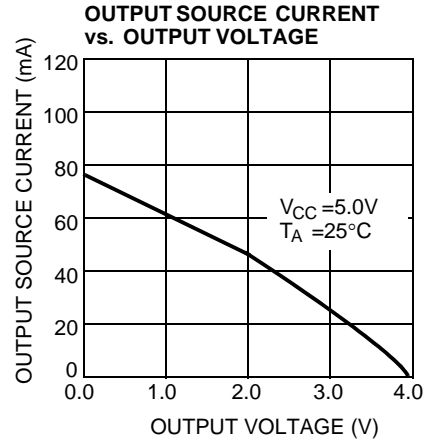
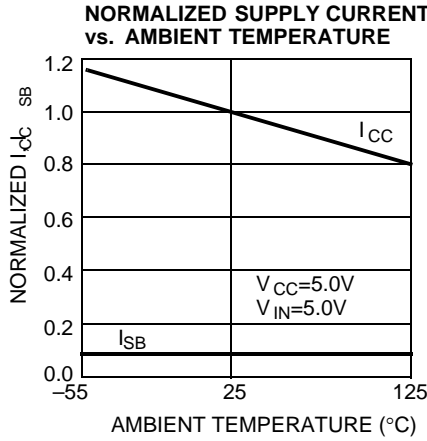
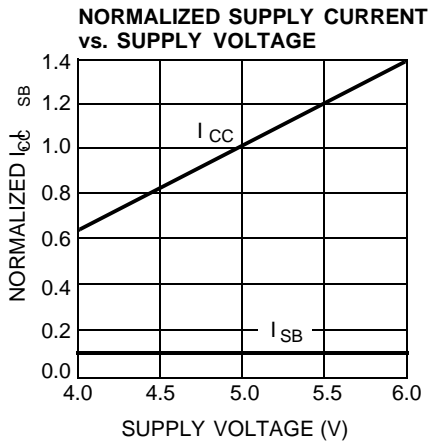

Truth Table

\overline{CE}_1	\overline{CE}_2	\overline{WE}	\overline{OE}	Input/Output	Mode
H	X	X	X	High Z	Deselect/Power-Down
X	L	X	X	High Z	Deselect/Power-Down
L	H	H	L	Data Out	Read
L	H	L	X	Data In	Write
L	H	H	H	High Z	Deselect

Address Designators

Address Name	Address Function	Pin Number
A4	X3	2
A5	X4	3
A6	X5	4
A7	X6	5
A8	X7	6
A9	Y1	7
A10	Y4	8
A11	Y3	9
A12	Y0	10
A0	Y2	21
A1	X0	23
A2	X1	24
A3	X2	25

Ordering Information

Speed (ns)	Ordering Code	Package Name	Package Type	Operating Range
15	CY7C185-15VC	51-85031	28-pin (300-Mil) Molded SOJ	Commercial
	CY7C185-15VI		28-pin (300-Mil) Molded SOJ	Industrial
20	CY7C185-20PC	51-85014	28-pin (300-Mil) Molded DIP	Commercial
	CY7C185-20PXC		28-pin (300-Mil) Molded DIP (Pb-free)	
	CY7C185-20VC	51-85031	28-pin (300-Mil) Molded SOJ	
25	CY7C185-25PC	51-85014	28-pin (300-Mil) Molded DIP	Commercial
	CY7C185-25VC	51-85031	28-pin (300-Mil) Molded SOJ	
35	CY7C185-35PC	51-85014	28-pin (300-Mil) Molded DIP	Commercial
	CY7C185-35SC	51-85026	28-pin (300-Mil) Molded SOIC	

Package Diagrams

28-pin (300-Mil) PDIP (51-85014)

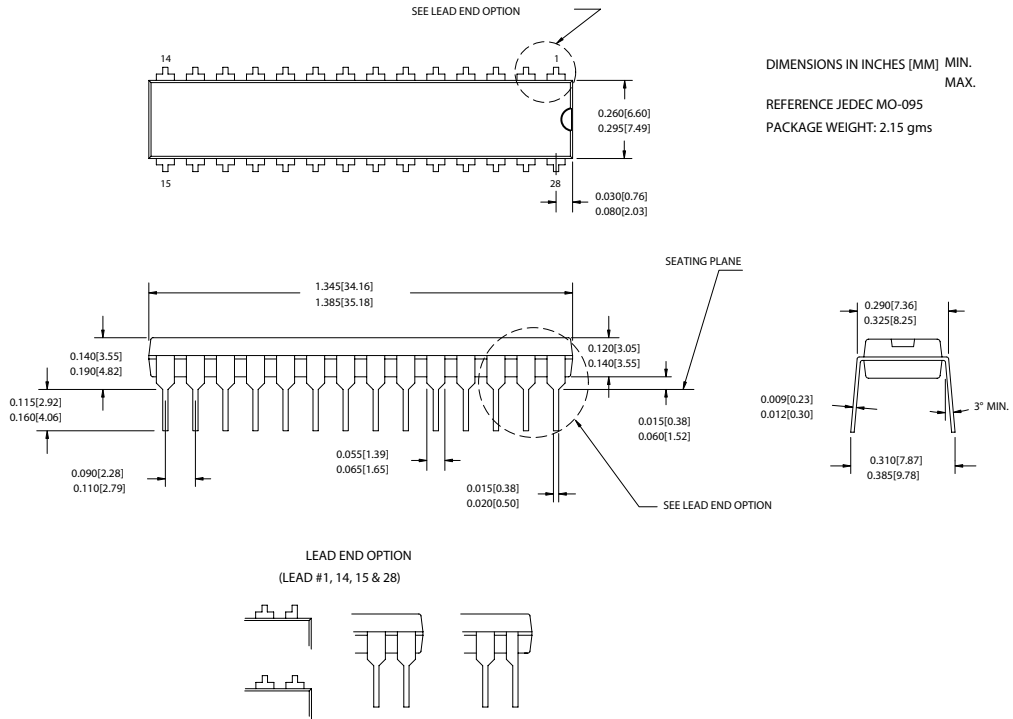

Package Diagrams (continued)

28-pin (300-Mil) Molded SOIC (51-85026)

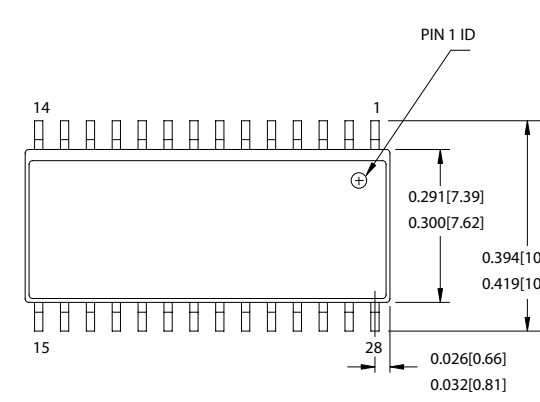

NOTE:

1. JEDEC STD REF MO-119
2. BODY LENGTH DIMENSION DOES NOT INCLUDE MOLD PROTRUSION/END FLASH, BUT DOES INCLUDE MOLD MISMATCH AND ARE MEASURED AT THE MOLD PARTING LINE. MOLD PROTRUSION/END FLASH SHALL NOT EXCEED 0.010 in (0.254 mm) PER SIDE
3. DIMENSIONS IN INCHES - MIN. MAX.
4. PACKAGE WEIGHT 0.85gms

PART #	
S28.3	STANDARD PKG.
SZ28.3	LEAD FREE PKG.

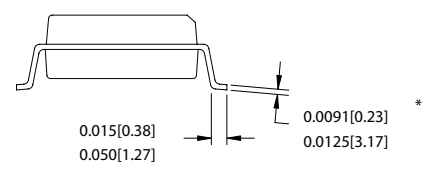
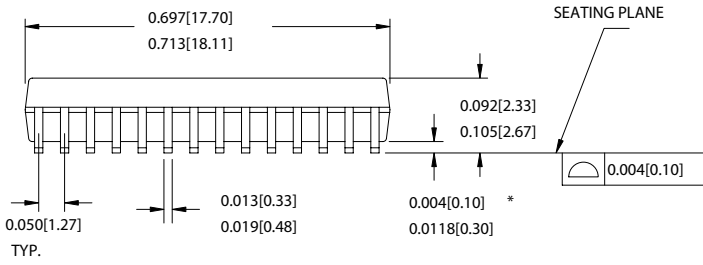

51-85026-*D

Package Diagrams (continued)

28-pin (300-Mil) Molded SOJ (51-85031)

NOTE:

- 1. JEDEC STD REF MO088
- 2. BODY LENGTH DIMENSION DOES NOT INCLUDE MOLD PROTRUSION/END FLASH
MOLD PROTRUSION/END FLASH SHALL NOT EXCEED 0.006 in (0.152 mm) PER SIDE
- 3. DIMENSIONS IN INCHES

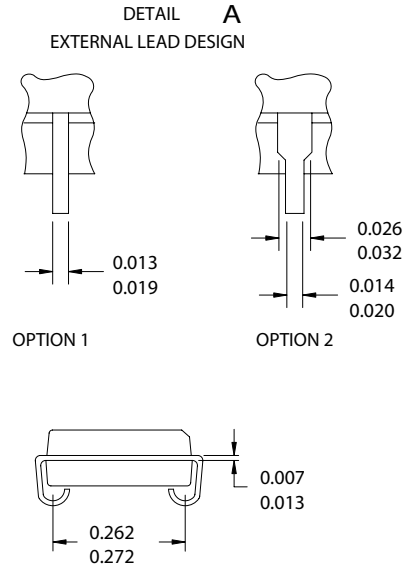
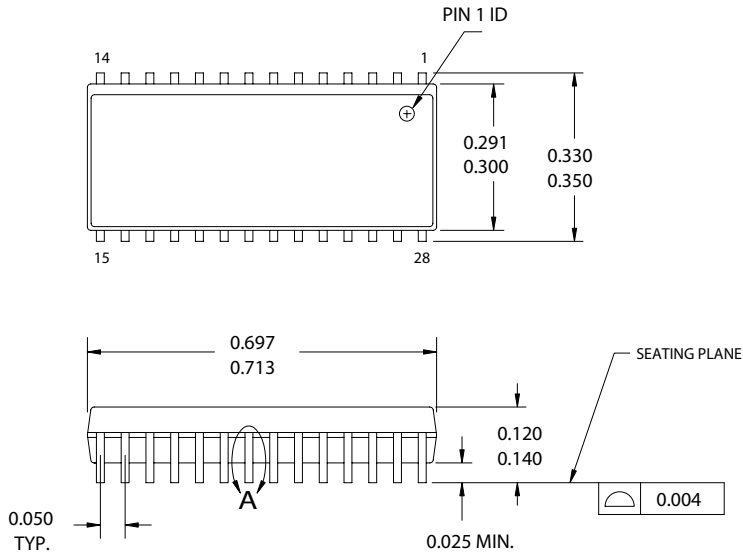

51-85031-°C

All product and company names mentioned in this document may be the trademarks of their respective holders.

Document History Page

Document Title: CY7C185 8K x 8 Static RAM Document Number: 38-05043				
REV.	ECN NO.	Issue Date	Orig. of Change	Description of Change
**	107145	09/10/01	SZV	Change from Spec number: 38-00037 to 38-05043
*A	116470	09/16/02	CEA	Add applications foot note to data sheet
*B	486744	See ECN	NXR	Changed Low standby power from 220mW to 85mW Changed the description of I_{IX} from Input Load Current to Input Leakage Current in DC Electrical Characteristics table Removed I_{OS} parameter from DC Electrical Characteristics table Updated the Ordering Information table