



## LM339

## LINEAR INTEGRATED CIRCUIT

### QUAD DIFFERENTIAL COMPARATOR

#### DESCRIPTION

The UTC **LM339** consists of four independent voltage comparators, designed specifically to operate from a single power supply over a wide voltage range.

#### FEATURES

- \*Signal or dual supply operation.
- \*Wide operating supply range ( $V_{CC}=2V\sim 36V$ ).
- \*Input common-mode voltage includes ground.
- \*Low supply current drain  $I_F=0.8mA$  (Typical).
- \*Open collector outputs for wired and connection.
- \*Low input bias current  $I_{BIAS}=25nA$  (Typical).
- \*Low output saturation voltage.
- \*Output compatible with TTL, DTL, and CMOS logic system.

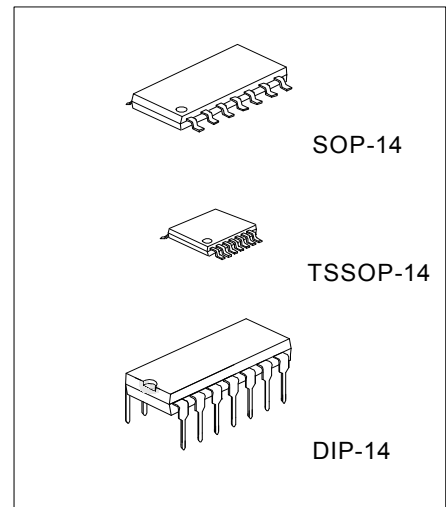

Lead-free: LM339L  
Halogen-free: LM339G

#### ORDERING INFORMATION

Ordering Number			Package	Packing
Normal	Lead Free Plating	Halogen-Free		
LM339-S14-R	LM339L-S14-R	LM339G-S14-R	SOP-14	Tape Reel
LM339-P14-R	LM339L-P14-R	LM339G-P14-R	TSSOP-14	Tape Reel
LM339-D14-T	LM339L-D14-T	LM339G-D14-T	DIP-14	Tube

<p>LM339L-S14-R</p> <p>(1)Packing Type (2)Package Type (3)Lead Plating</p>	<p>(1) R: Tape Reel, T: Tube (2) S14: SOP-14, P14: TSSOP-14, D14: DIP-14 (3) G: Halogen Free, L: Lead Free Plating, Blank: Pb/Sn</p>
--	--

## ■ PIN CONFIGURATION

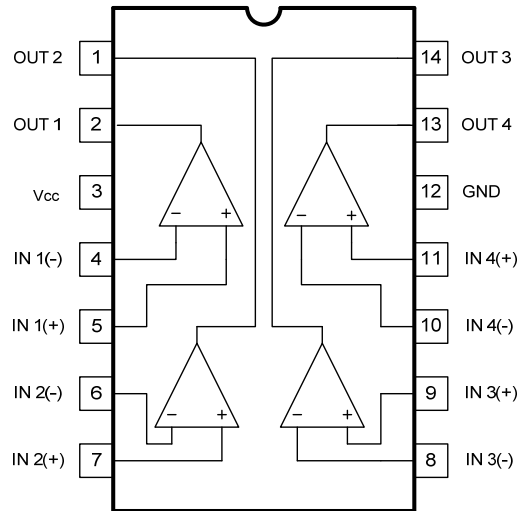

■ BLOCK DIAGRAM

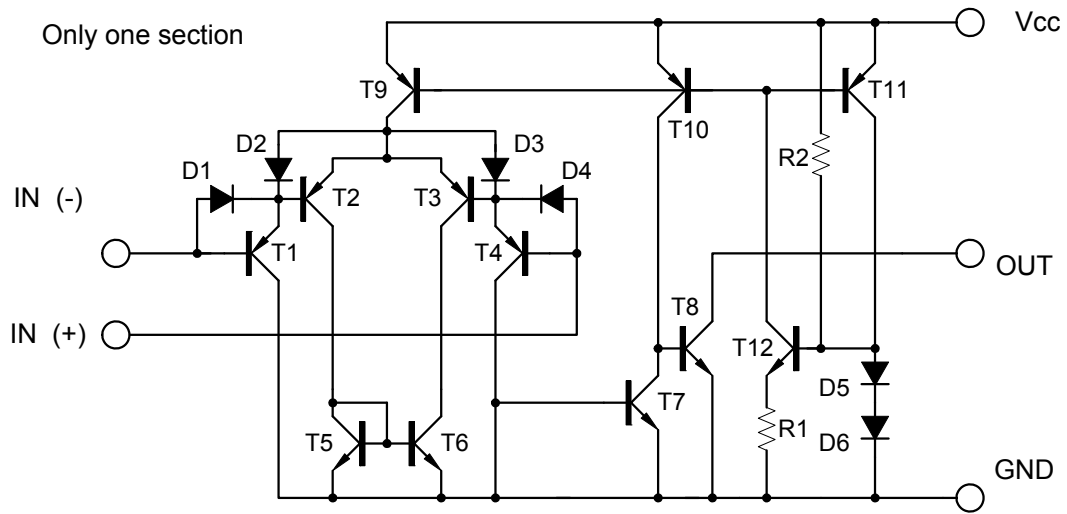

### ■ ABSOLUTE MAXIMUM RATINGS (Ta=25°C)

PARAMETER	SYMBOL	RATINGS	UNIT
Supply Voltage	V <sub>CC</sub>	+ - 18 or 36	V
Differential input Voltage	V <sub>I(DIFF)</sub>	36	V
Input Voltage	V <sub>IN</sub>	-0.3~36	V
Power Dissipation	DIP-14	760	mW
	SOP-14	560	mW
	TSSOP-14	440	mW
Junction Temperature	T <sub>J</sub>	125	°C
Operating Temperature	T <sub>OPR</sub>	-20 ~ +85	°C
Storage Temperature	T <sub>STG</sub>	-40 ~ 150	°C

Note: Absolute maximum ratings are those values beyond which the device could be permanently damaged. Absolute maximum ratings are stress ratings only and functional device operation is not implied.

### ■ ELECTRICAL CHARACTERISTICS

(V<sub>CC</sub>=5.0V, Ta=25°C, All voltage referenced to GND unless otherwise specified)

PARAMETER	SYMBOL	TEST CONDITIONS	MIN	TYP.	MAX	UNIT
Input Offset Voltage	V <sub>I(OFF)</sub>	V <sub>CM</sub> =0 ~ V <sub>CC</sub> -1.5 V <sub>OUT(p)</sub> =1.4V, R <sub>S</sub> =0		+1.5	+5.0	mV
Input Offset Current	I <sub>I(OFF)</sub>			+2.3	+50	nA
Input Bias Current	I <sub>BIAS</sub>			57	250	nA
Input Common-Mode Voltage Range	V <sub>IN(R)</sub>		0		V <sub>CC</sub> -1.5	V
Supply Current	I <sub>CC</sub>	R <sub>L</sub> =∞		1.1	2.0	mA
Large Signal Voltage Gain	G <sub>V</sub>	V <sub>CC</sub> =15V, R <sub>L</sub> >15kΩ	50	200		V/mV
Large Signal Response Time	t <sub>res</sub>	V <sub>IN</sub> =TTL logic wing V <sub>REF</sub> =1.4V, V <sub>RL</sub> =5V, R <sub>L</sub> =5.1kΩ		350		ns
Response Time	t <sub>res</sub>	V <sub>RL</sub> =5V, R <sub>L</sub> =5.1kΩ		1400		ns
Output Sink Current	I <sub>SINK</sub>	V <sub>IN</sub> (-)>1V, V <sub>IN</sub> (+)=0V, V <sub>OUT(p)</sub> <1.5V	6	18		mA
Output Saturation Voltage	V <sub>SAT</sub>	V <sub>IN</sub> (-)>1V, V <sub>IN</sub> (+)=0V, I <sub>SINK</sub> =4mA		140	400	mV
Output Leakage Current	I <sub>LEAK</sub>	V <sub>IN</sub> (+)=1V, V <sub>IN</sub> (-)=0 V <sub>OUT(p)</sub> = 5V V <sub>OUT</sub> (p)=30V		0.1	1.0	nA μA
Differential Input Voltage	V <sub>IN(DIFF)</sub>				36	V

## TYPICAL CHARACTERISTICS

Fig.1 Supply Current

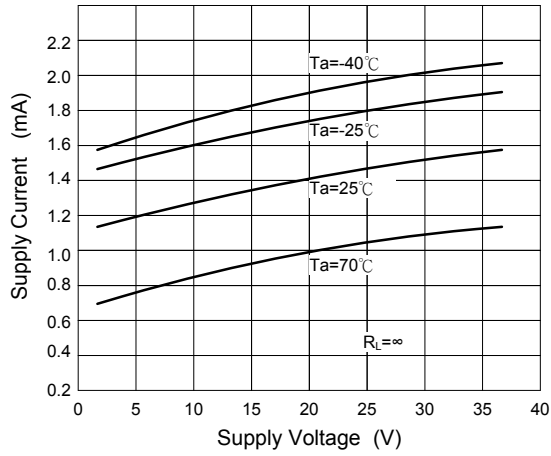

Fig.2 Input Current

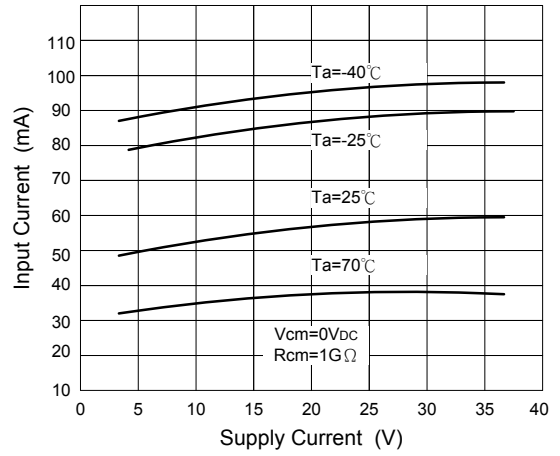

Fig.3 Output Saturation Voltage

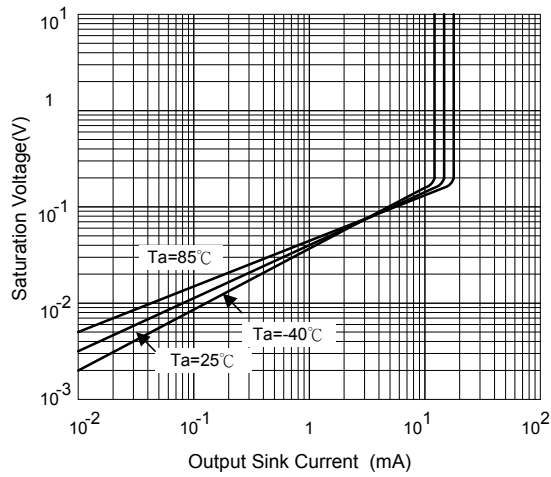

Fig.4 Reponse Time For Various Input Overdrive Negative Transition

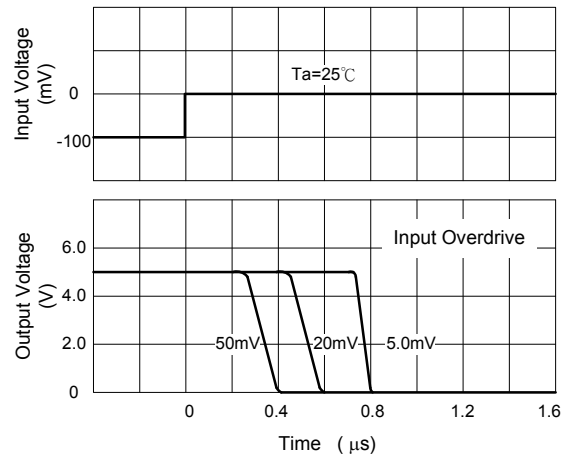
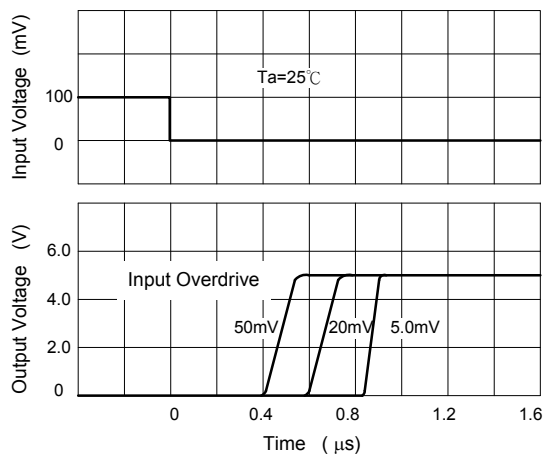

Fig.5 Reponse Time For Various Input Overdrive Positive Transition



## ■ TYPICAL CHARACTERISTICS(cont.)

Fig.6

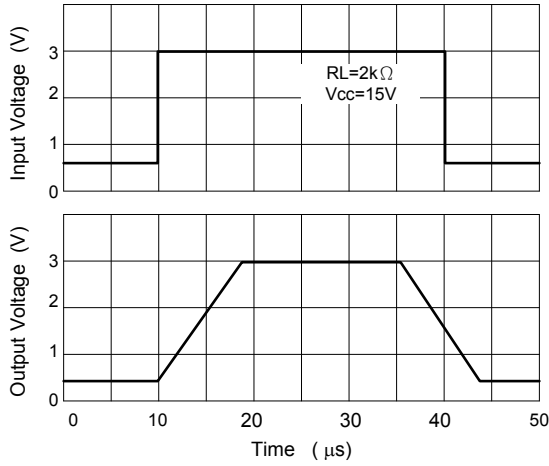

Fig.7 Voltage Follower Pulse Response (Small Signal)

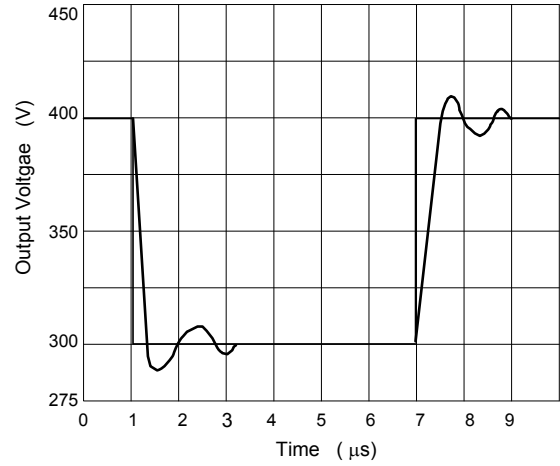

Fig.8 Large Signal Frequency Response

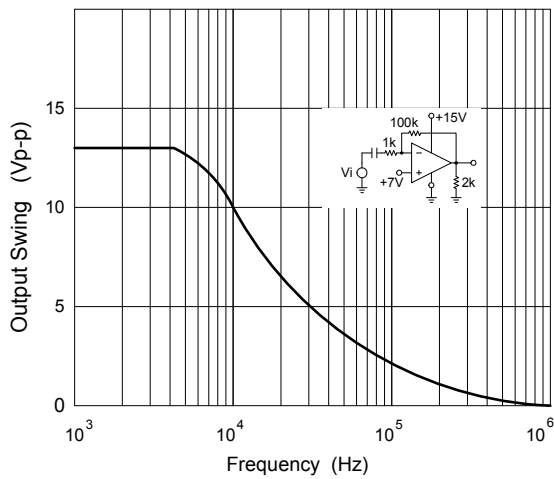

Fig.9 Output Characteristics Current Sourcing

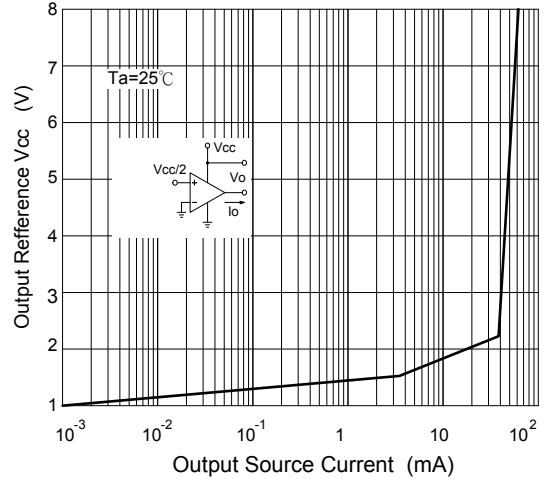

Fig.10 Output Characteristics Current Sinking

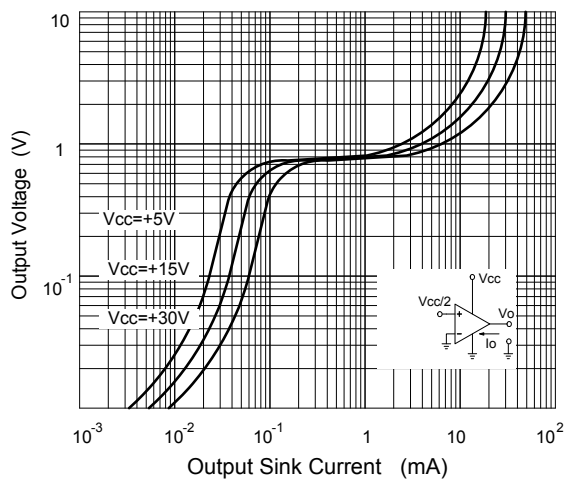
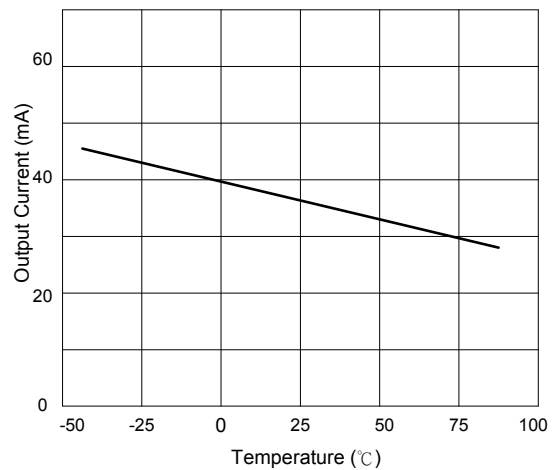

Fig.11 Current Limiting



UTC assumes no responsibility for equipment failures that result from using products at values that exceed, even momentarily, rated values (such as maximum ratings, operating condition ranges, or other parameters) listed in products specifications of any and all UTC products described or contained herein. UTC products are not designed for use in life support appliances, devices or systems where malfunction of these products can be reasonably expected to result in personal injury. Reproduction in whole or in part is prohibited without the prior written consent of the copyright owner. The information presented in this document does not form part of any quotation or contract, is believed to be accurate and reliable and may be changed without notice.