

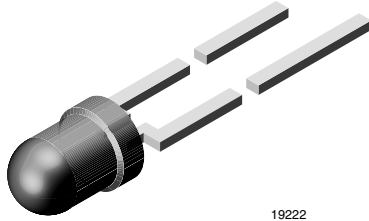

High Efficiency LED in \varnothing 3 mm Clear Package



19222

DESCRIPTION

The TLH.4900 series was developed for applications where high light output is required.

It is housed in a 3 mm clear plastic package. The small viewing angle of these devices provides a high brightness.

All LEDs are categorized in luminous intensity groups. The green and yellow LEDs are categorized additionally in wavelength groups.

That allows users to assemble LEDs with uniform appearance.

PRODUCT GROUP AND PACKAGE DATA

- Product group: LED
- Package: 3 mm
- Product series: standard
- Angle of half intensity: $\pm 16^\circ$

FEATURES

- Choice of four bright colors
- Standard \varnothing 3 mm (T-1) package
- Small mechanical tolerances
- Suitable for DC and high peak current
- Very small viewing angle
- Luminous intensity categorized
- Yellow and green color categorized
- Lead (Pb)-free device



APPLICATIONS

- Status lights
- Off/on indicator
- Background illumination
- Readout lights
- Maintenance lights
- Legend light

PARTS TABLE

PART	COLOR, LUMINOUS INTENSITY	TECHNOLOGY
TLHR4900	Red, $I_V > 6.3$ mcd	GaAsP on GaP
TLHY4900	Yellow, $I_V > 10$ mcd	GaAsP on GaP
TLHG4900	Green, $I_V > 16$ mcd	GaP on GaP

ABSOLUTE MAXIMUM RATINGS ¹⁾ TLHG4900, TLHR4900, TLHY4900

PARAMETER	TEST CONDITION	SYMBOL	VALUE	UNIT
Reverse voltage		V_R	6	V
DC Forward current	$T_{amb} \leq 60^\circ\text{C}$	I_F	30	mA
Surge forward current	$t_p \leq 10 \mu\text{s}$	I_{FSM}	1	A
Power dissipation	$T_{amb} \leq 60^\circ\text{C}$	P_V	100	mW
Junction temperature		T_j	100	$^\circ\text{C}$
Operating temperature range		T_{amb}	- 40 to + 100	$^\circ\text{C}$
Storage temperature range		T_{stg}	- 55 to + 100	$^\circ\text{C}$
Soldering temperature	$t \leq 5$ s, 2 mm from body	T_{sd}	260	$^\circ\text{C}$
Thermal resistance junction/ambient		R_{thJA}	400	K/W

Note:

¹⁾ $T_{amb} = 25^\circ\text{C}$, unless otherwise specified

OPTICAL AND ELECTRICAL CHARACTERISTICS ¹⁾ TLHR4900, RED						
PARAMETER	TEST CONDITION	SYMBOL	MIN.	TYP.	MAX.	UNIT
Luminous intensity ²⁾	$I_F = 10 \text{ mA}$	I_V	6.3	25		mcd
Dominant wavelength	$I_F = 10 \text{ mA}$	λ_d	612		625	nm
Peak wavelength	$I_F = 10 \text{ mA}$	λ_p		635		nm
Angle of half intensity	$I_F = 10 \text{ mA}$	φ		± 16		deg
Forward voltage	$I_F = 20 \text{ mA}$	V_F		2	3	V
Reverse voltage	$I_R = 10 \mu\text{A}$	V_R	6	15		V
Junction capacitance	$V_R = 0, f = 1 \text{ MHz}$	C_j		50		pF

Note:

¹⁾ $T_{amb} = 25 \text{ }^\circ\text{C}$, unless otherwise specified

²⁾ In one packing unit $I_{Vmin}/I_{Vmax} \leq 0.5$

OPTICAL AND ELECTRICAL CHARACTERISTICS ¹⁾ TLHY4900, YELLOW						
PARAMETER	TEST CONDITION	SYMBOL	MIN.	TYP.	MAX.	UNIT
Luminous intensity ²⁾	$I_F = 10 \text{ mA}$	I_V	10	26		mcd
Dominant wavelength	$I_F = 10 \text{ mA}$	λ_d	581		594	nm
Peak wavelength	$I_F = 10 \text{ mA}$	λ_p		585		nm
Angle of half intensity	$I_F = 10 \text{ mA}$	φ		± 16		deg
Forward voltage	$I_F = 20 \text{ mA}$	V_F		2.4	3	V
Reverse voltage	$I_R = 10 \mu\text{A}$	V_R	6	15		V
Junction capacitance	$V_R = 0, f = 1 \text{ MHz}$	C_j		50		pF

Note:

¹⁾ $T_{amb} = 25 \text{ }^\circ\text{C}$, unless otherwise specified

²⁾ In one packing unit $I_{Vmin}/I_{Vmax} \leq 0.5$

OPTICAL AND ELECTRICAL CHARACTERISTICS ¹⁾ TLHG4900, GREEN						
PARAMETER	TEST CONDITION	SYMBOL	MIN.	TYP.	MAX.	UNIT
Luminous intensity ²⁾	$I_F = 10 \text{ mA}$	I_V	16	37		mcd
Dominant wavelength	$I_F = 10 \text{ mA}$	λ_d	562		575	nm
Peak wavelength	$I_F = 10 \text{ mA}$	λ_p		565		nm
Angle of half intensity	$I_F = 10 \text{ mA}$	φ		± 16		deg
Forward voltage	$I_F = 20 \text{ mA}$	V_F		2.4	3	V
Reverse voltage	$I_R = 10 \mu\text{A}$	V_R	6	15		V
Junction capacitance	$V_R = 0, f = 1 \text{ MHz}$	C_j		50		pF

Note:

¹⁾ $T_{amb} = 25 \text{ }^\circ\text{C}$, unless otherwise specified

²⁾ In one packing unit $I_{Vmin}/I_{Vmax} \leq 0.5$

LUMINOUS INTENSITY CLASSIFICATION		
GROUP	LUMINOUS INTENSITY (mcd)	
	MIN.	MAX.
Q	6.3	12.5
R	10	20
S	16	32
T	25	50
U	40	80
V	63	125



COLOR CLASSIFICATION				
GROUP	DOM. WAVELENGTH (nm)			
	YELLOW		GREEN	
	MIN.	MAX.	MIN.	MAX.
0				
1	581	584		
2	583	586		
3	585	588	562	565
4	587	590	564	567
5	589	592	566	569
6	591	594	568	571
7			570	573
8			572	575

Note:

The above type numbers represent the order groups which include only a few brightness groups. Only one group will be shipped on each reel or bulk (there will be no mixing of two groups on one reel/bulk). In order to ensure availability, single brightness groups will not be orderable. In a similar manner for colors where wavelength groups are measured and binned, single wavelength groups will be shipped on any one reel/bulk. In order to ensure availability, single wavelength groups will not be orderable.

TYPICAL CHARACTERISTICS

T_{amb} = 25 °C, unless otherwise specified

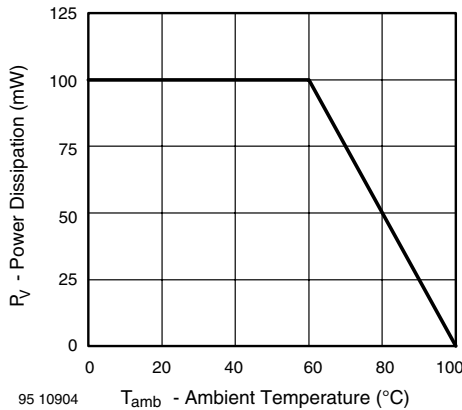

Figure 1. Power Dissipation vs. Ambient Temperature

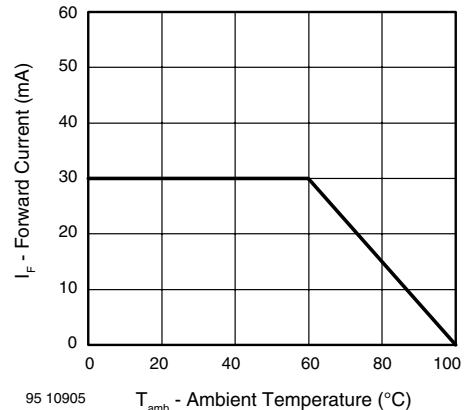

Figure 2. Forward Current vs. Ambient Temperature for InGaN

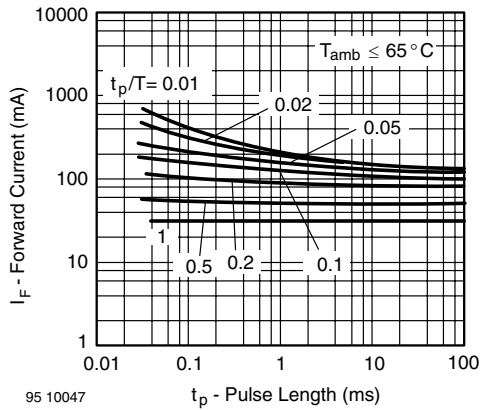

Figure 3. Forward Current vs. Pulse Length

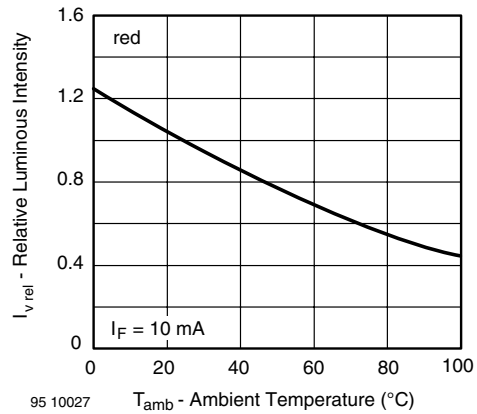

Figure 6. Rel. Luminous Intensity vs. Ambient Temperature

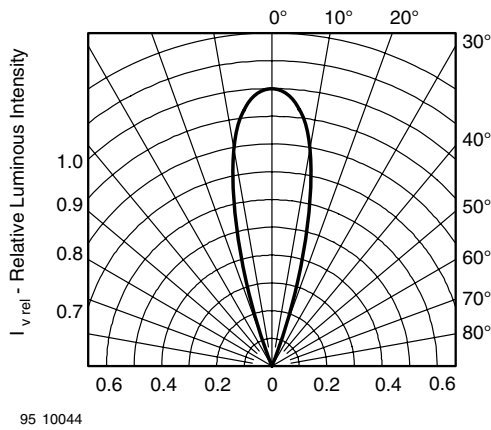

Figure 4. Rel. Luminous Intensity vs. Angular Displacement

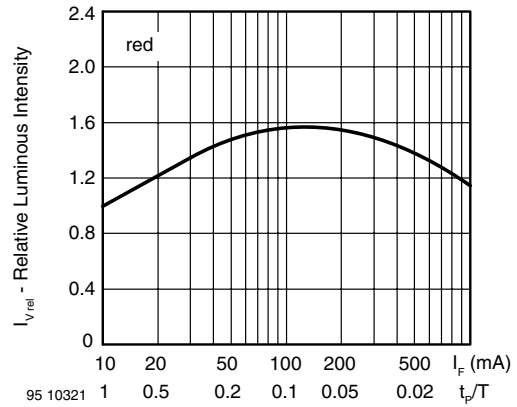

Figure 7. Rel. Lumin. Intensity vs. Forw. Current/Duty Cycle

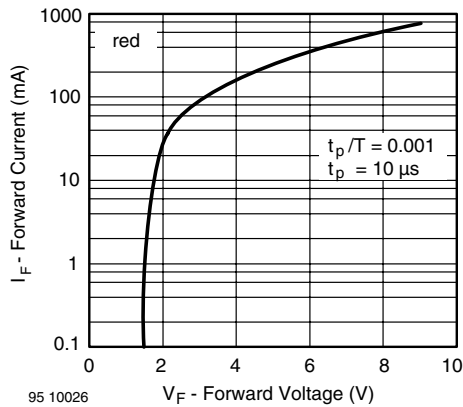

Figure 5. Forward Current vs. Forward Voltage

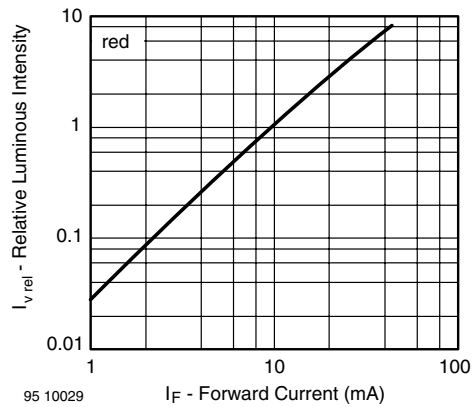

Figure 8. Relative Luminous Intensity vs. Forward Current

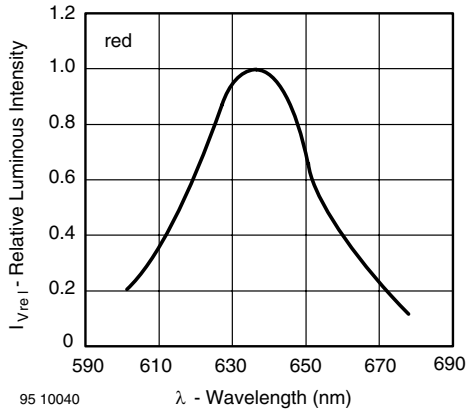

Figure 9. Relative Intensity vs. Wavelength

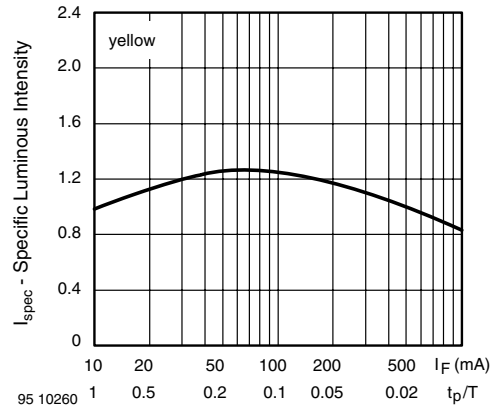

Figure 12. Rel. Lumin. Intensity vs. Forw. Current/Duty Cycle

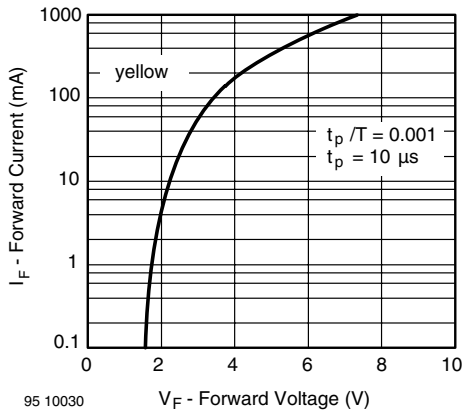

Figure 10. Forward Current vs. Forward Voltage

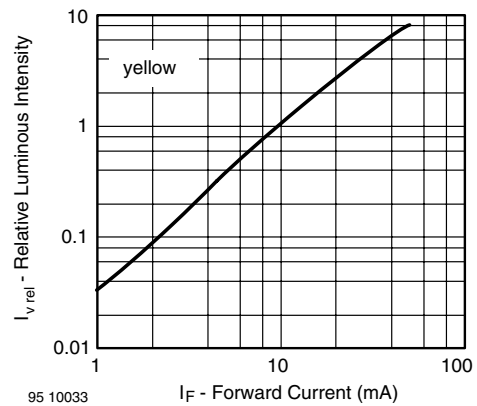

Figure 13. Relative Luminous Intensity vs. Forward Current

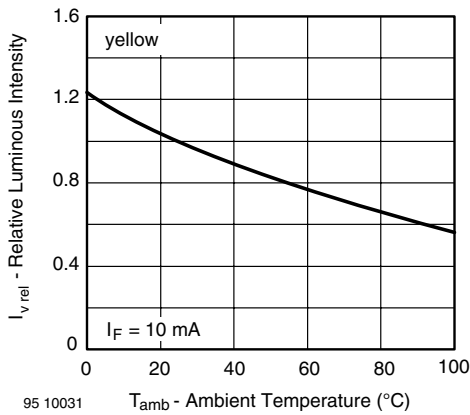

Figure 11. Rel. Luminous Intensity vs. Ambient Temperature

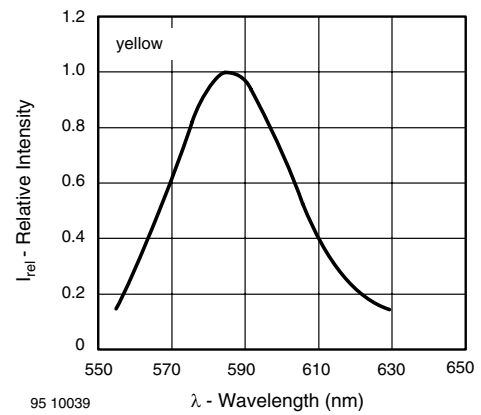

Figure 14. Relative Intensity vs. Wavelength

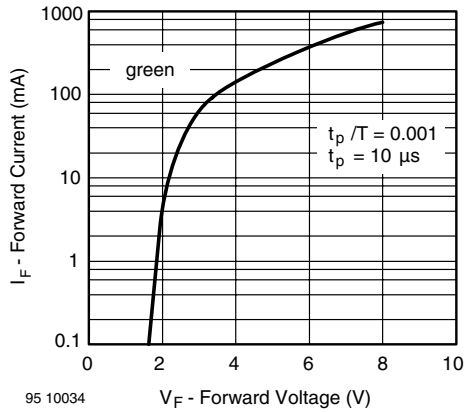

Figure 15. Forward Current vs. Forward Voltage

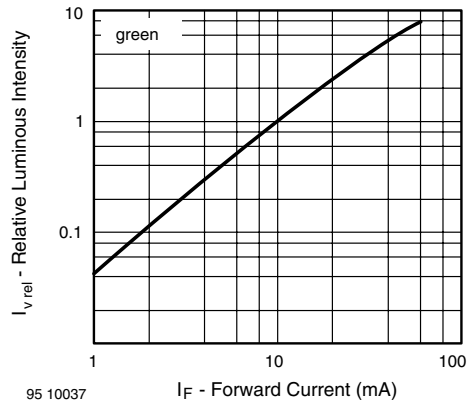

Figure 18. Relative Luminous Intensity vs. Forward Current

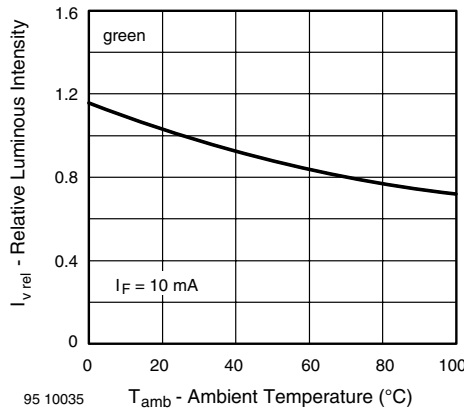

Figure 16. Rel. Luminous Intensity vs. Ambient Temperature

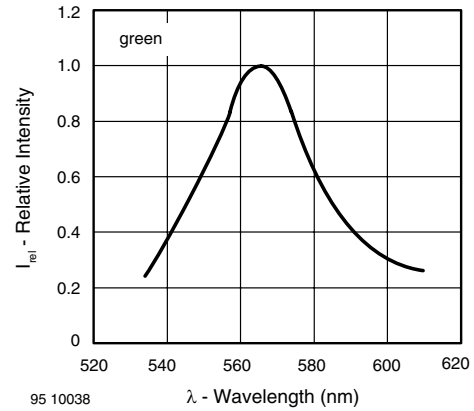

Figure 19. Relative Intensity vs. Wavelength

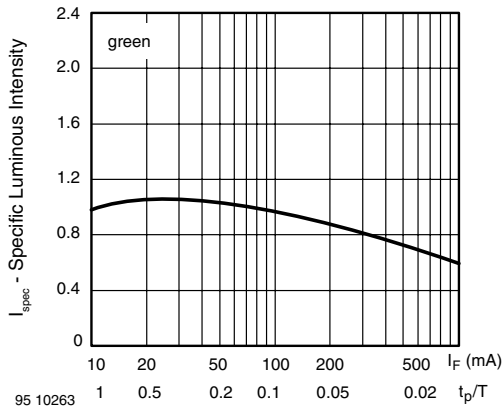
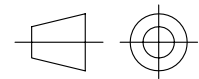
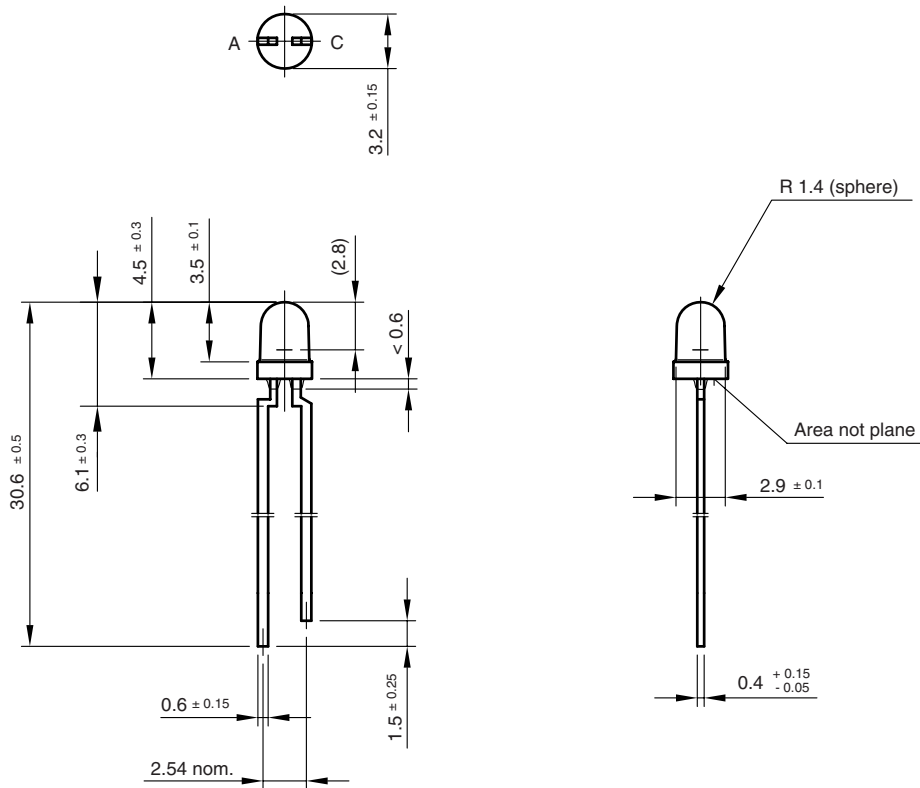

Figure 17. Specific Luminous Intensity vs. Forward Current



PACKAGE DIMENSIONS in millimeters



technical drawings
according to DIN
specifications

Drawing-No.: 6.544-5255.02-4

Issue: 3; 23.04.98

95 10914



Disclaimer

All product specifications and data are subject to change without notice.

Vishay Intertechnology, Inc., its affiliates, agents, and employees, and all persons acting on its or their behalf (collectively, "Vishay"), disclaim any and all liability for any errors, inaccuracies or incompleteness contained herein or in any other disclosure relating to any product.

Vishay disclaims any and all liability arising out of the use or application of any product described herein or of any information provided herein to the maximum extent permitted by law. The product specifications do not expand or otherwise modify Vishay's terms and conditions of purchase, including but not limited to the warranty expressed therein, which apply to these products.

No license, express or implied, by estoppel or otherwise, to any intellectual property rights is granted by this document or by any conduct of Vishay.

The products shown herein are not designed for use in medical, life-saving, or life-sustaining applications unless otherwise expressly indicated. Customers using or selling Vishay products not expressly indicated for use in such applications do so entirely at their own risk and agree to fully indemnify Vishay for any damages arising or resulting from such use or sale. Please contact authorized Vishay personnel to obtain written terms and conditions regarding products designed for such applications.

Product names and markings noted herein may be trademarks of their respective owners.