

Low I_Q , Low Dropout 150mA Fixed Voltage Regulator

Features

- **Low Noise: 60mV_{RMS} (100Hz to 100kHz)**
- **Low Quiescent Current: 50mA**
- **Low Dropout Voltage: 300mV**
($V_{\text{OUT}}(\text{Nominal}) = 3.0\text{V}$ Version @150mA)
- **Very Low Shutdown Current: $< 0.5\text{mA}$**
- **Fixed Output Voltage: 1.3V, 1.4V, 1.5V, 1.6V, 1.7V, 1.8V, 1.9V, 2.0V, 2.1V, 2.2V, 2.3V, 2.4V, 2.5V, 2.6V, 2.7V, 2.8V, 2.85V, 2.9V, 3.0V, 3.1V, 3.2V, 3.3V, 3.4V, 3.5V, 4.3V, 4.75V, 4.8V, 4.9V, 5.0V**
- **Stable with 1mF Output Capacitor**
- **Stable with Aluminum, Tantalum, or Ceramic Capacitors**
- **Reverse Current Protection**
- **No Protection Diodes Needed**
- **Built-In Thermal Protection**
- **Built-In Current-Limit Protection**
- **Controlled Short Circuit Current: 50mA**
- **Fast transient Response**
- **Short Setting Time**
- **SOT-23-5 Package**
- **Lead Free and Green Devices Available (RoHS Compliant)**

General Description

The APL5151/5152/5153/5154 are low-power and low dropout linear regulators, which can operate in the range of 2.7V to 6V input voltage and deliver up to 150mA output current. Typical dropout voltage is only 300mV (typical) at 150mA output current. The APL5151/5152/5153/5154 regulators with low 50 μA quiescent current are ideal for battery powered system appliances. The APL5151/5152/5153/5154 regulators are stable with a 1 μF ceramic capacitor. The features of current-limit, short circuit current-limit, and over-temperature protection protect the device from current over loads and over temperature. The APL5151/5152/5153/5154 regulators are available in a SOT-23-5 package.

Pin Configuration

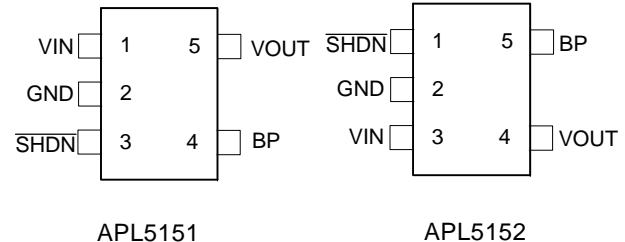

Applications

- **Notebook Computer**
- **PDA or Portable Equipments**
- **Noise-Sensitive Instrumentation Systems**

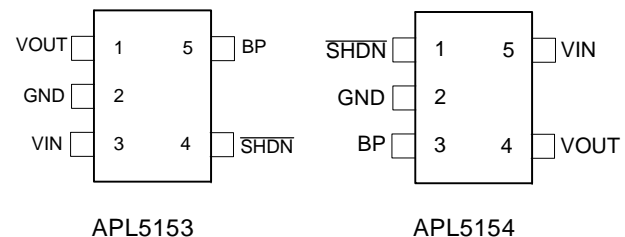

ANPEC reserves the right to make changes to improve reliability or manufacturability without notice, and advise customers to obtain the latest version of relevant information to verify before placing orders.

Ordering Marking and Information

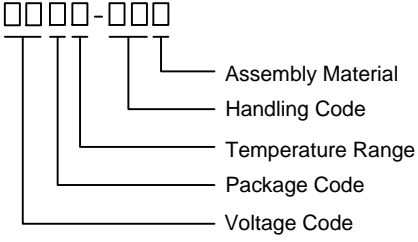
APL5151 APL5152 APL5153 APL5154		Package Code B : SOT-23-5 Temperature Range C : 0 to 70 °C I : -40 to 85 °C Handling Code TR : Tape & Reel Voltage Code : 13 : 1.3V ~ 50 : 5.0V (see below for details) Assembly Material G : Halogen and Lead Free Device
--	---	--

Note: ANPEC lead-free products contain molding compounds/die attach materials and 100% matte tin plate termination finish; which are fully compliant with RoHS. ANPEC lead-free products meet or exceed the lead-free requirements of IPC/JEDEC J-STD-020C for MSL classification at lead-free peak reflow temperature. ANPEC defines "Green" to mean lead-free (RoHS compliant) and halogen free (Br or Cl does not exceed 900ppm by weight in homogeneous material and total of Br and Cl does not exceed 1500ppm by weight).

Product Name	Marking	Product Name	Marking	Product Name	Marking	Product Name	Marking
APL5151-13B	1517X	APL5152-13B	1527X	APL5153-13B	1537X	APL5154-13B	1547X
APL5151-14B	1518X	APL5152-14B	1528X	APL5153-14B	1538X	APL5154-14B	1548X
APL5151-15B	1519X	APL5152-15B	1529X	APL5153-15B	1539X	APL5154-15B	1549X
APL5151-16B	151AX	APL5152-16B	152AX	APL5153-16B	153AX	APL5154-16B	154AX
APL5151-17B	151BX	APL5152-17B	152BX	APL5153-17B	153BX	APL5154-17B	154BX
APL5151-18B	151CX	APL5152-18B	152CX	APL5153-18B	153CX	APL5154-18B	154CX
APL5151-19B	151DX	APL5152-19B	152DX	APL5153-19B	153DX	APL5154-19B	154DX
APL5151-20B	151EX	APL5152-20B	152EX	APL5153-20B	153EX	APL5154-20B	154EX
APL5151-21B	151FX	APL5152-21B	152FX	APL5153-21B	153FX	APL5154-21B	154FX
APL5151-22B	151GX	APL5152-22B	152GX	APL5153-22B	153GX	APL5154-22B	154GX
APL5151-23B	151HX	APL5152-23B	152HX	APL5153-23B	153HX	APL5154-23B	154HX
APL5151-24B	151IX	APL5152-24B	152IX	APL5153-24B	153IX	APL5154-24B	154IX
APL5151-25B	151JX	APL5152-25B	152JX	APL5153-25B	153JX	APL5154-25B	154JX
APL5151-26B	151KX	APL5152-26B	152KX	APL5153-26B	153KX	APL5154-26B	154KX
APL5151-27B	151LX	APL5152-27B	152LX	APL5153-27B	153LX	APL5154-27B	154LX
APL5151-28B	151MX	APL5152-28B	152MX	APL5153-28B	153MX	APL5154-28B	154MX
APL5151-285B	151dX	APL5152-285B	152dX	APL5153-285B	153dX	APL5154-285B	154dX
APL5151-29B	151NX	APL5152-29B	152NX	APL5153-29B	153NX	APL5154-29B	154NX
APL5151-30B	151OX	APL5152-30B	152OX	APL5153-30B	153OX	APL5154-30B	154OX
APL5151-31B	151PX	APL5152-31B	152PX	APL5153-31B	153PX	APL5154-31B	154PX
APL5151-32B	151QX	APL5152-32B	152QX	APL5153-32B	153QX	APL5154-32B	154QX
APL5151-33B	151RX	APL5152-33B	152RX	APL5153-33B	153RX	APL5154-33B	154RX
APL5151-34B	151SX	APL5152-34B	152SX	APL5153-34B	153SX	APL5154-34B	154SX
APL5151-35B	151TX	APL5152-35B	152TX	APL5153-35B	153TX	APL5154-35B	154TX
APL5151-43B	151fX	APL5152-43B	152fX	APL5153-43B	153fX	APL5154-43B	154fX
APL5151-475B	1514X	APL5152-475B	1524X	APL5153-475B	1534X	APL5154-475B	1544X
APL5151-48B	151XX	APL5152-48B	152XX	APL5153-48B	153XX	APL5154-48B	154XX
APL5151-49B	151YX	APL5152-49B	152YX	APL5153-49B	153YX	APL5154-49B	154YX
APL5151-50B	151ZX	APL5152-50B	152ZX	APL5153-50B	153ZX	APL5154-50B	154ZX

The last character "X" in the marking is for data code.

Absolute Maximum Ratings (Note 1)

Symbol	Parameter	Rating	Unit
V_{IN}, V_{OUT}	Input Voltage, Output Voltage	6.5	V
V_{SHDN}	Shutdown Control Pin Voltage	6.5	V
$R_{TH,JA}$	Thermal Resistance – Junction to Ambient	260	°C/W
$R_{TH,JC}$	Thermal Resistance – Junction to Case	130	°C/W
P_D	Power Dissipation	Internally Limited	W
T_J	Maximum Junction Temperature	0 to 150	°C
T_{STG}	Storage Temperature Range	-65 to +150	°C
T_{SDR}	Maximum Lead Temperature Soldering, 10 Seconds	260	°C

Note 1: Absolute Maximum Ratings are those values beyond which the life of a device may be impaired. Exposure to absolute maximum rating conditions for extended periods may affect device reliability.

Electrical Characteristics

Unless otherwise noted these specifications apply over full temperature, $V_{IN}=3.6V$, $C_{IN}=C_{OUT}=1\mu F$, $SHDN=V_{IN}$, $T_A = -40$ to $85^\circ C$. Typical values refer to $T_A=25^\circ C$.

Symbol	Parameter	Test Conditions	APL5151/2/3/4			Unit	
			Min.	Typ.	Max.		
V_{IN}	Input Voltage		2.7	-	6	V	
V_{OUT}	Output Voltage	$V_{OUT}+1.0V < V_{IN} < 6.0V$, $0mA < I_{OUT} < I_{MAX}$	$V_{OUT}-2\%$	V_{OUT}	$V_{OUT}+2\%$	V	
I_{LIMIT}	Circuit Current Limit	$V_{IN}=V_{OUT}+1V$	250	300	350	mA	
I_{SHORT}	Short Current	$V_{OUT}=0V$	40	50	60	mA	
I_{OUT}	Load Current		150	-	-	mA	
REG_{LINE}	Line Regulation	$V_{OUT}+0.5V < V_{IN} < 6.0V$, $0mA < I_{OUT} < I_{MAX}$	-	4	10	mV	
REG_{LOAD}	Load Regulation	$V_{IN} = V_{OUT}+1.0V$, $0mA < I_{OUT} < I_{MAX}$	-	1	6	mV	
	Load Transient	$V_{IN}=V_{OUT}+1V$, $I_{OUT}=1mA-150mA$ in $1\mu s$	-	70	150	mV	
PSRR	Ripple Rejection	$f \leq 1kHz$, $1V_{pp}$ at $V_{IN} = V_{OUT}+1.0V$ $C_{BP} = 0.1\mu F$, $C_{OUT} = 1\mu F$	45	55	-	dB	
V_{DROP}	Dropout Voltage (Note 2)	$I_{OUT} = 150mA$	$1.3V \leq V_{OUT} < 1.5V$	-	1.2	1.4	V
			$1.5V \leq V_{OUT} < 2.0$	-	1	1.2	
			$2.0V \leq V_{OUT} < 2.5$	-	0.7	0.8	
			$2.5V \leq V_{OUT} < 3$	-	0.3	0.4	
			$3V \leq V_{OUT} \leq 5$	-	0.2	0.3	
I_Q	Quiescent Current	No load	-	50	80	μA	
		$I_{OUT} = 150mA$	-	135	170		
	Shutdown Supply Current	$V_{SHDN}=0V$ $I_{OUT}=0$, $V_{IN}=6.0V$	-	0.01	1	μA	
	Noise	$100Hz < f < 100kHz$, $C_{BP} = 0.1\mu F$, $C_{OUT} = 1\mu F$	-	80	-	μV_{rms}	
		$100Hz < f < 100kHz$, $C_{BP} = 0.33\mu F$, $C_{OUT} = 1\mu F$	-	60	-		
	Shutdown Recovery Delay	$C_{BP} = 0.1\mu F$, $C_{OUT} = 1\mu F$, no load	-	4	-	ms	
		$C_{BP} = 0.33\mu F$, $C_{OUT} = 1\mu F$, no load	-	13.2	-		
OTS	Over Temperature Shutdown		-	150	-	°C	

Electrical Characteristics (Cont.)

Unless otherwise noted these specifications apply over full temperature, $V_{IN}=3.6V$, $C_{IN}=C_{OUT}=1\mu F$, $\overline{SHDN}=V_{IN}$, $T_A = -40$ to $85^\circ C$. Typical values refer to $T_A=25^\circ C$.

Symbol	Parameter	Test Conditions	APL5151/2/3/4			Unit
			Min.	Typ.	Max.	
	Over Temperature Shutdown Hysteresis	Hysteresis	-	10	-	$^\circ C$
TC	Output Voltage Temperature Coefficient		-	50	-	ppm/ $^\circ C$
C_{OUT}	Output Capacitor		0.8	1.0	2.6	μF
	ESR		0.02	0.1	1	Ω
	Shutdown Input Threshold	$V_{OUT}+1.0V < V_{IN} < 6.0V$	0.4	1.6	2.5	V
$I_{\overline{SHDN}}$	Shutdown Input Bias Current	$V_{\overline{SHDN}} = V_{IN}$	-	0.01	100	nA
	Input Reverse Leakage Current	$V_{OUT} - V_{IN} = 0.1V$	-	0.1	0.5	μA
	Reverse Protection Threshold		-	11	50	mV

Note 2: Dropout voltage definition : $V_{IN} - V_{OUT}$ when V_{OUT} is 2% below the value of V_{OUT} for $V_{IN} = V_{OUT} + 0.5V$.

Typical Operating Characteristics

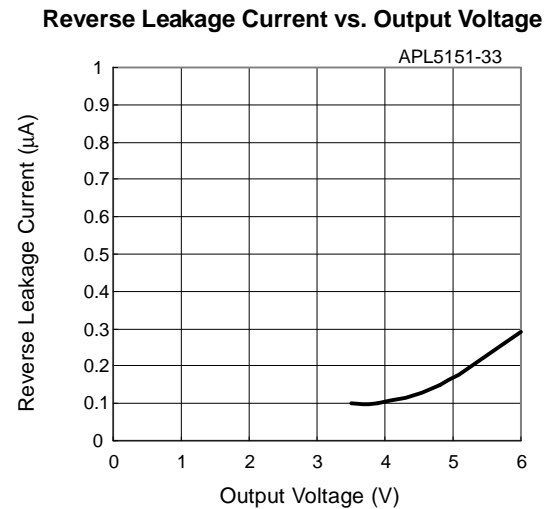
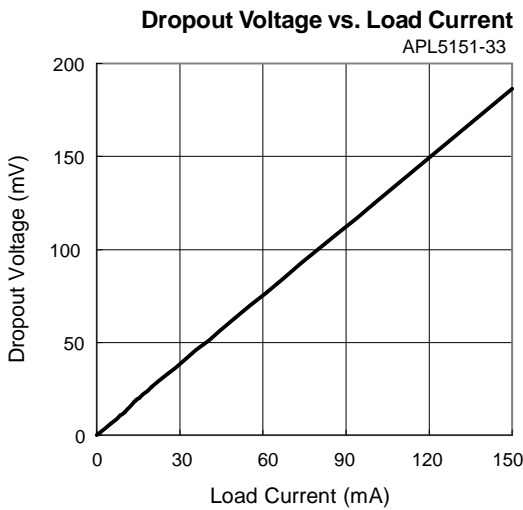
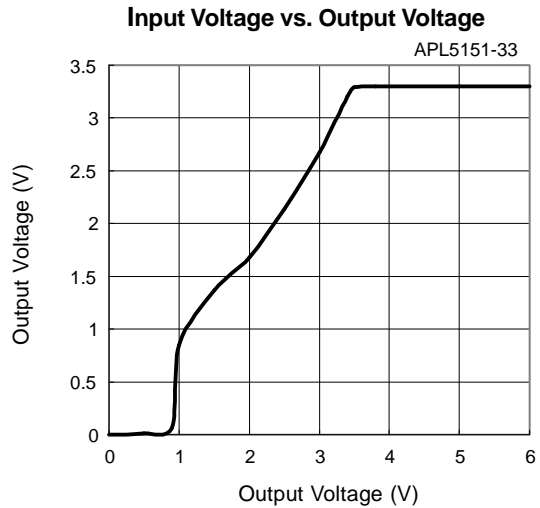
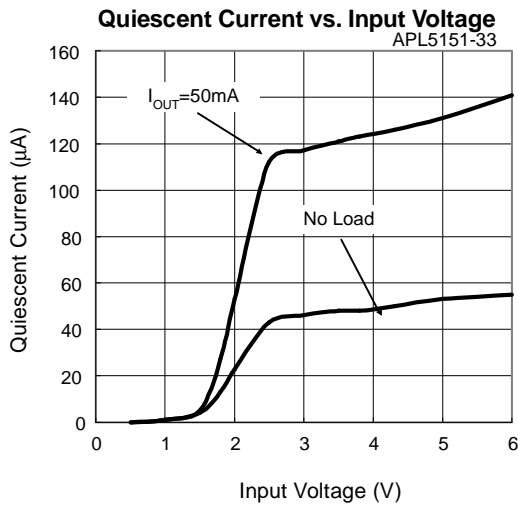
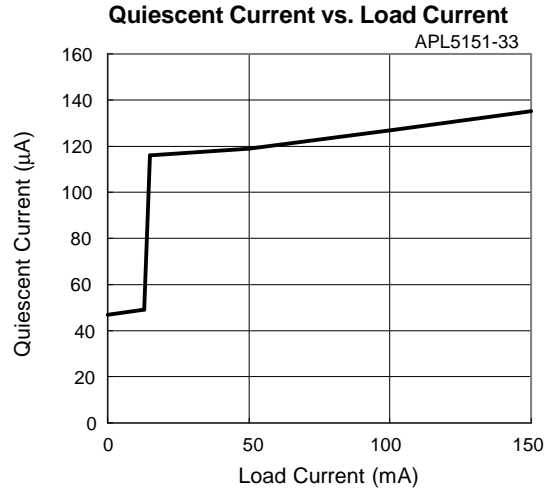
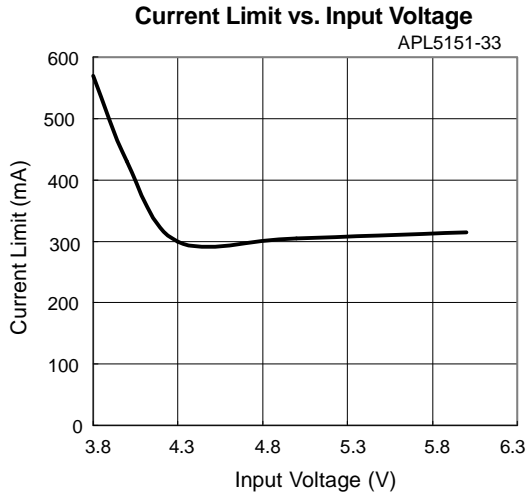

Typical Operating Characteristics (Cont.)

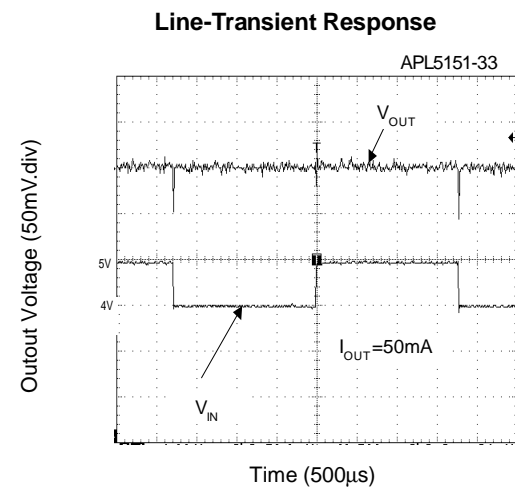
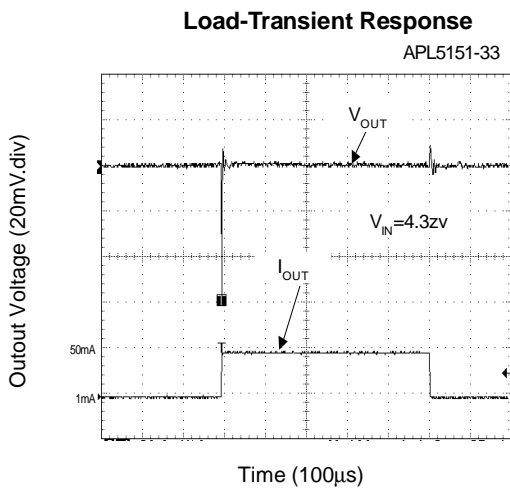
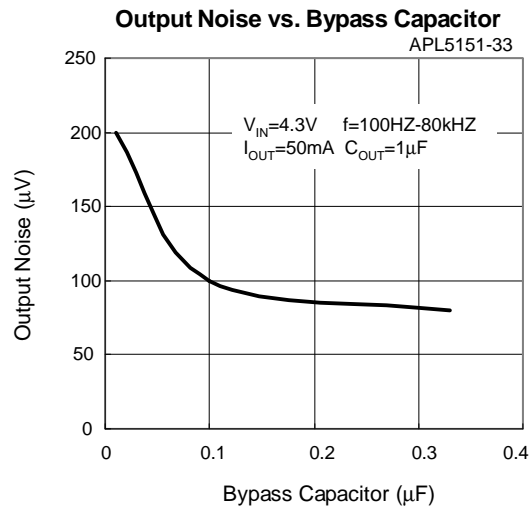
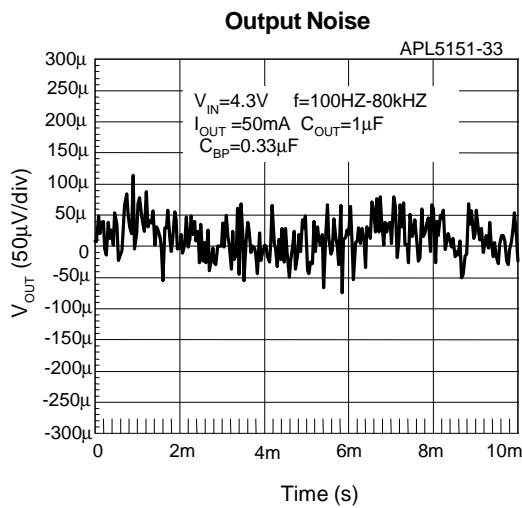
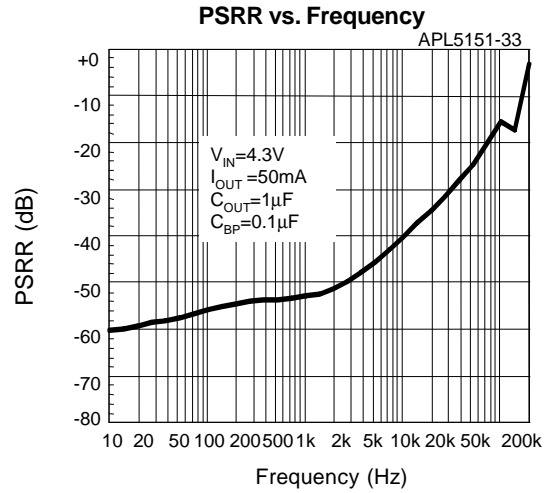
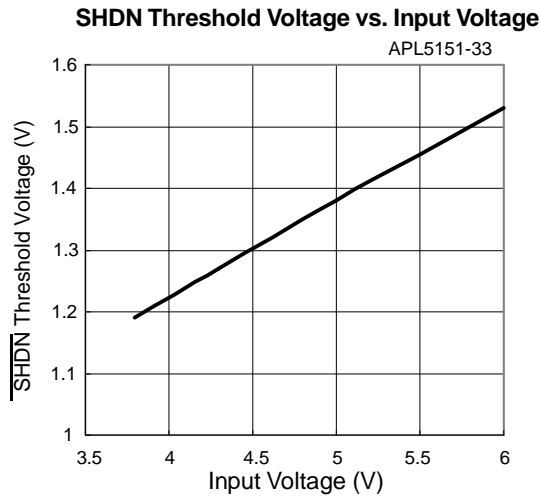

Typical Operating Characteristics (Cont.)

Shutdown Exit Delay

APL5151-33

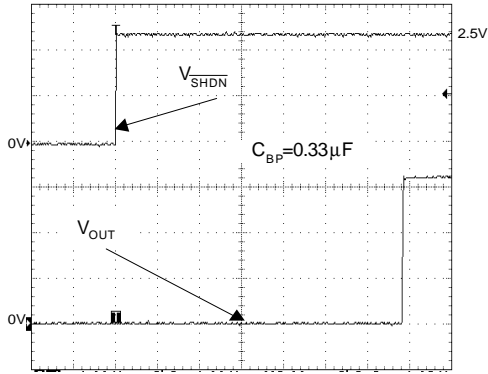

Shutdown Exit Delay

APL5151-33

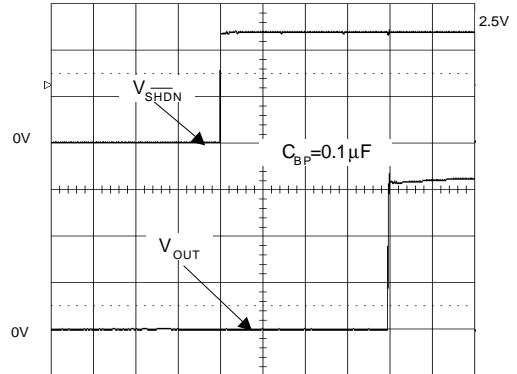

Entering Shutdown

APL5151-33

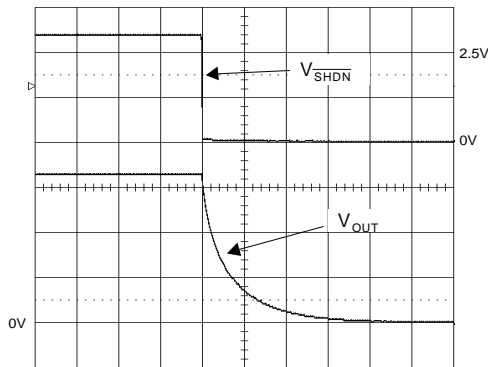

Region of Stable C_OUT ESR vs. Load Current

APL5151-33

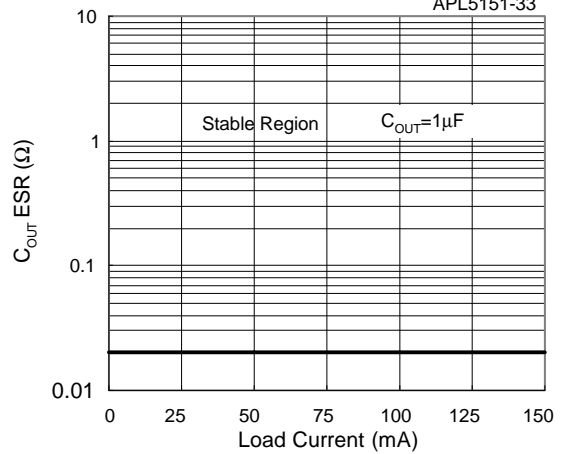

Output Voltage vs. Junction Temperature

APL5151-33

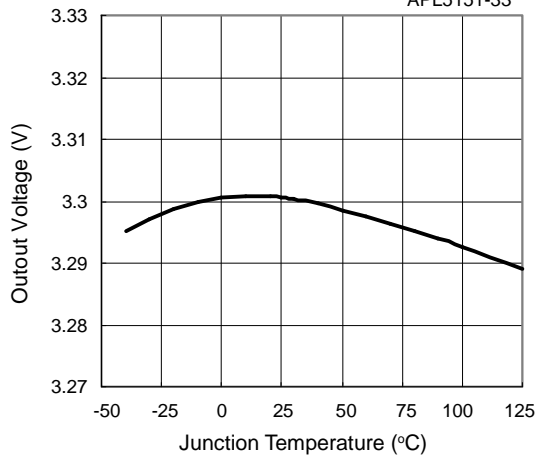

Pin Description

PIN		Function
NO.	NAME	
1	VIN	Input Supply Pin. Provides power to the IC, V_{IN} can range from 2.7V to 6V and should be bypassed with at least a $1\mu\text{F}$ capacitor to GND.
2	GND	Ground. Solder to a large ground plane for heatsinking.
3	$\overline{\text{SHDN}}$	Active-Low Shutdown Input. $\overline{\text{SHDN}}$ is a digital input that turns the regulator on or off. Drive $\overline{\text{SHDN}}$ high to turn on the regulator, drive it low to turn it off. Connect this pin to VIN if it is not used.
4	BP	Reference-Noise Bypass. Bypass with a $0.01\mu\text{F}$ ceramic capacitor for reduced noise at the output.
5	VOUT	LDO Output. Sources up to 150mA. Bypass with at least a $1\mu\text{F}$ capacitor to GND.

Typical Application Circuit

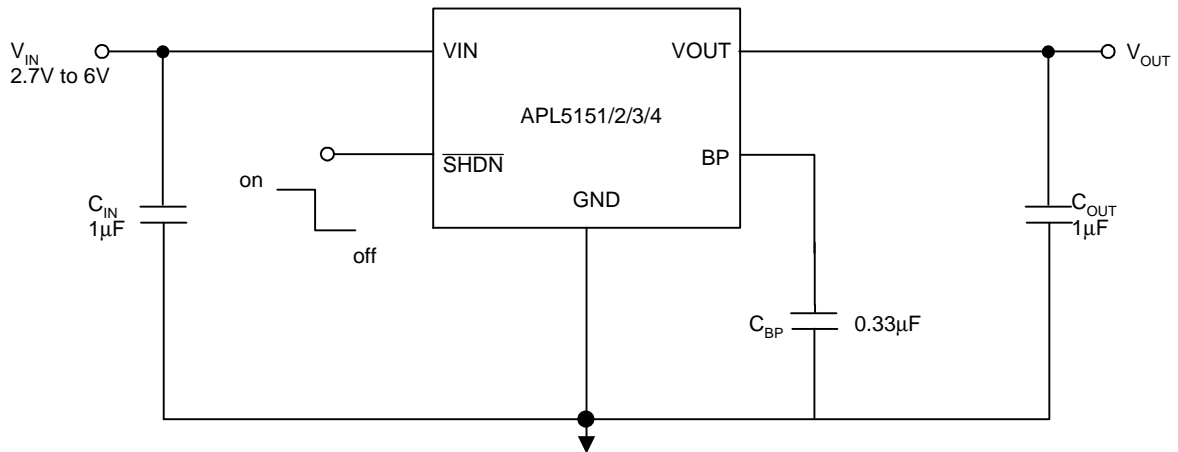

Application Information

Capacitor Selection and Regulator Stability

The APL5151/2/3/4 use at least a 1 μ F capacitor on the input, and this capacitor can be Aluminum, Tantalum, or Ceramic capacitor. The input capacitor with larger value and lower ESR provides better PSRR and line-transient response. The output capacitor also can use Aluminum, Tantalum, or Ceramic capacitor, and a minimum value of 1 μ F and ESR above 0.06 Ω is recommended. The curve of the stable region in typical characteristics shows the appropriate output capacitor ESR for different load current stable operation. A larger output capacitor can reduce noise and improve load-transient response, stability, and PSRR. Note that some ceramic dielectrics exhibit large capacitance and ESR variation with temperature. When using this capacitor, a minimum 2.2 μ F or more may be required to ensure the stability at low temperature operation. Use a bypass capacitor at BP pin for low output noise. Increasing the capacitance will slightly decrease the output noise but increase the start-up time (See Shutdown Exit Delay and Output Noise vs. Bypass Capacitor graph in the Typical Operating Characteristics).

Load-Transient Consideration

The APL5151/5152/5153/5154 load-transient response graphs in Typical Operating Characteristics show the transient response. A step changes in the load current from 1mA to 50mA at 1 μ s will cause a 60mV transient spike. Larger output capacitor and lower ESR can reduce transient spike.

Input-Output (Dropout) Voltage

The minimum input-output voltage difference (dropout) determines the lowest usable supply voltage. In battery-powered systems, this will determine the useful end-of-life battery voltage. Because the APL5151/5152/5153/5154 use a p-channel MOSFET pass transistor, the dropout voltage is the function of drain-to-source on-resistance ($R_{DS(ON)}$) multiplied by the load current.

Reverse Current Protection

The APL5151/5152/5153/5154 have an internal reverse protection, therefore, it is not necessary to use an external Schottky diode to connect the regulator input and output. If the output voltage is forced above the input volt-

age by more than 11mV, the IC will be shutdown and the ground pin current is below 0.1 μ A.

Current Limit

The APL5151/5152/5153/5154 provide a current-limit circuitry, which monitors and controls P-MOS's gate voltage, limiting the output current to 300mA. For reliable operation, the device should not be operated in current limit for extended period. When output is shortened to the ground, the APL5151/5152/5153/5154 will keep short circuit current at 50mA

Thermal Protection

Thermal protection limits total power dissipation in the device. When the junction temperature exceeds $T_J=+150^{\circ}\text{C}$, the thermal sensor generates a logic signal to turn off the pass transistor and allows IC to cool. When the IC's junction temperature is down by 10 $^{\circ}\text{C}$, the thermal sensor will turn the pass transistor on again, resulting in a pulsed output during continuous thermal protection. Thermal protection is designed to protect the APL5151/5152/5153/5154 in the event of fault conditions. For continuous operation, the junction temperature cannot exceed $T_J=+125^{\circ}\text{C}$.

Operating Region and Power Dissipation

The thermal resistance of the case to circuit board, and the rate of air flow all control the APL5151/5152/5153/5154's maximum power dissipation. The power dissipation across the device is $P_D = I_{OUT}(V_{IN}-V_{OUT})$ and the maximum power dissipation is:

$$P_{DMAX} = (T_J - T_A) / (\theta_{JC} + \theta_{CA})$$

where $T_J - T_A$ is the temperature difference between the junction and ambient air, θ_{JC} is the thermal resistance of the package, and θ_{CA} is the thermal resistance through the printed circuit board, copper traces, and other materials to the ambient air.

The GND pin of the APL5151/5152/5153/5154 provide an electrical connection to the ground and channeling heat away. If power dissipation is large, connect the GND pin to the ground using a large pad or ground plane, can improve the problem of over heat of IC.

Package Information

SOT-23-5

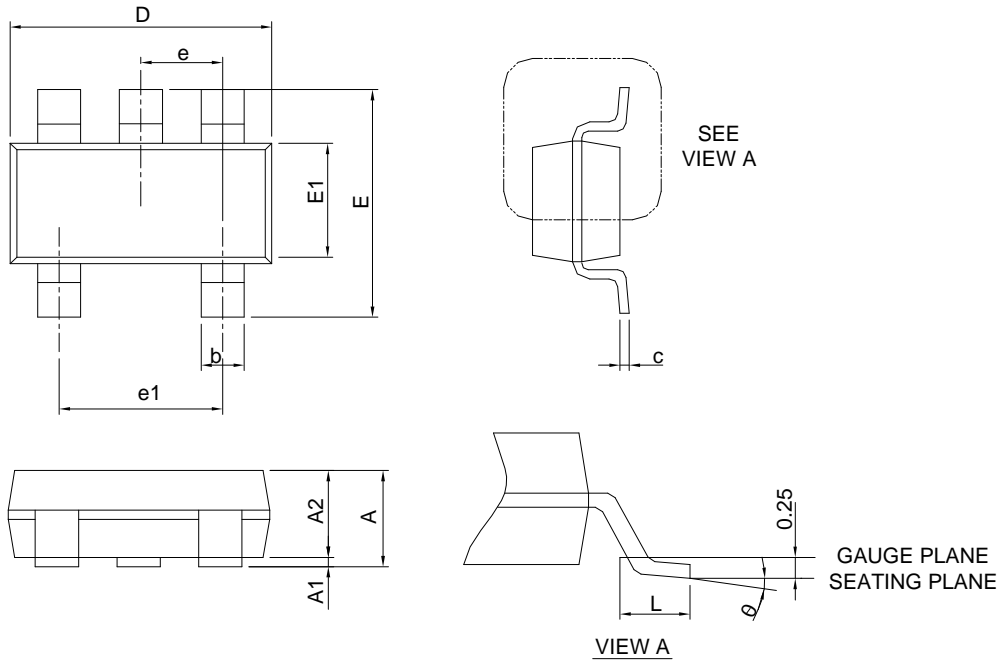

SYMBOL	SOT-23-5			
	MILLIMETERS		INCHES	
	MIN.	MAX.	MIN.	MAX.
A		1.45		0.057
A1	0.00	0.15	0.000	0.006
A2	0.90	1.30	0.035	0.051
b	0.30	0.50	0.012	0.020
c	0.08	0.22	0.003	0.009
D	2.70	3.10	0.106	0.122
E	2.60	3.00	0.102	0.118
E1	1.40	1.80	0.055	0.071
e	0.95 BSC		0.037 BSC	
e1	1.90 BSC		0.075 BSC	
L	0.30	0.60	0.012	0.024
θ	0°	8°	0°	8°

Note : 1. Follow JEDEC TO-178 AA.

2. Dimension D and E1 do not include mold flash, protrusions or gate burrs. Mold flash, protrusion or gate burrs shall not exceed 10 mil per side.

Carrier Tape & Reel Dimensions

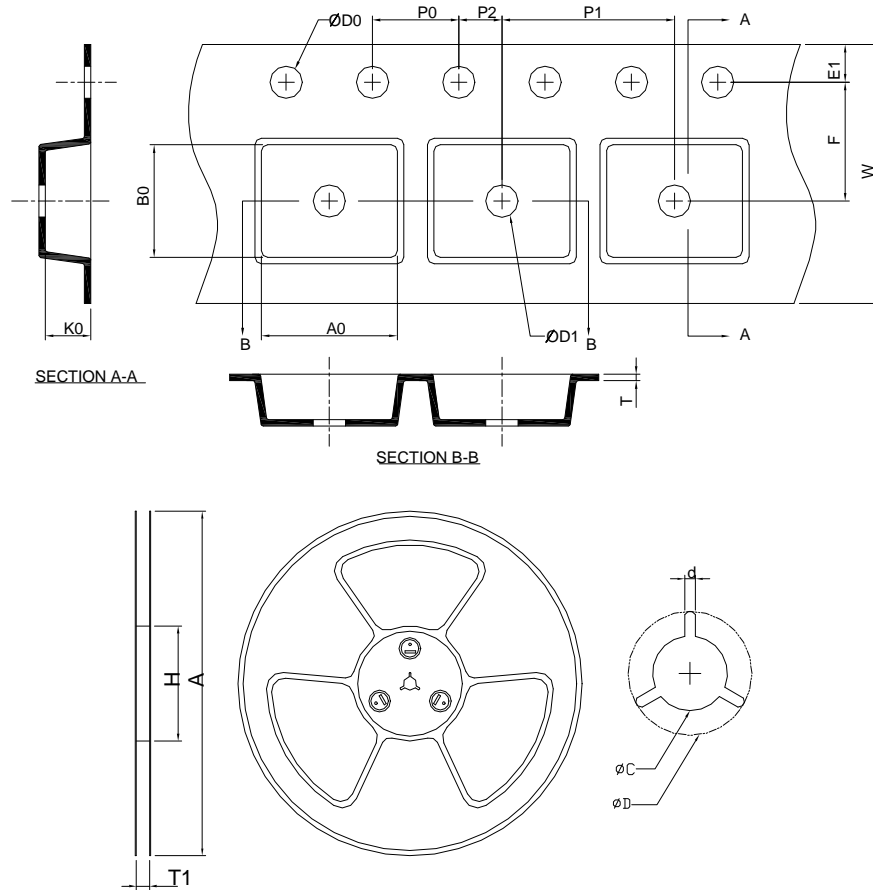

Application	A	H	T1	C	d	D	W	E1	F
SOT-23-5	178.0 ±2.00	50 MIN.	8.4+2.00 -0.00	13.0+0.50 -0.20	1.5 MIN.	20.2 MIN.	8.0 ±0.30	1.75 ±0.10	3.5 ±0.05
	P0	P1	P2	D0	D1	T	A0	B0	K0
	4.0 ±0.10	4.0 ±0.10	2.0 ±0.05	1.5+0.10 -0.00	1.0 MIN.	0.6+0.00 -0.40	3.20 ±0.20	3.10 ±0.20	1.50 ±0.20

(mm)

Devices Per Unit

Package Type	Unit	Quantity
SOT-23-5	Tape & Reel	3000

Taping Direction Information

SOT-23-5

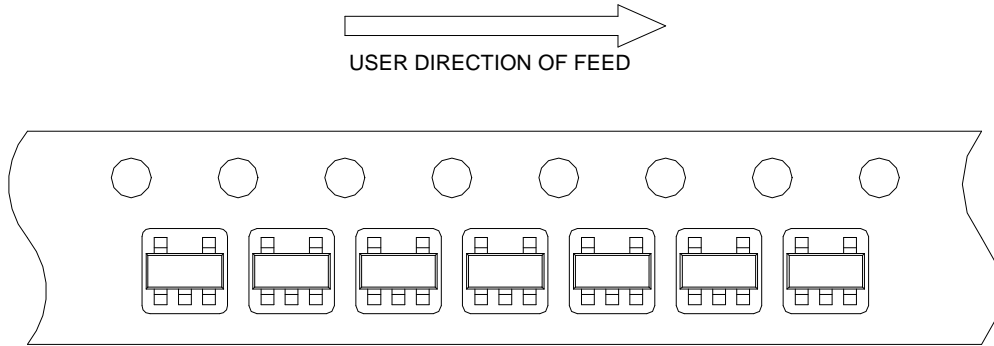

Classification Profile

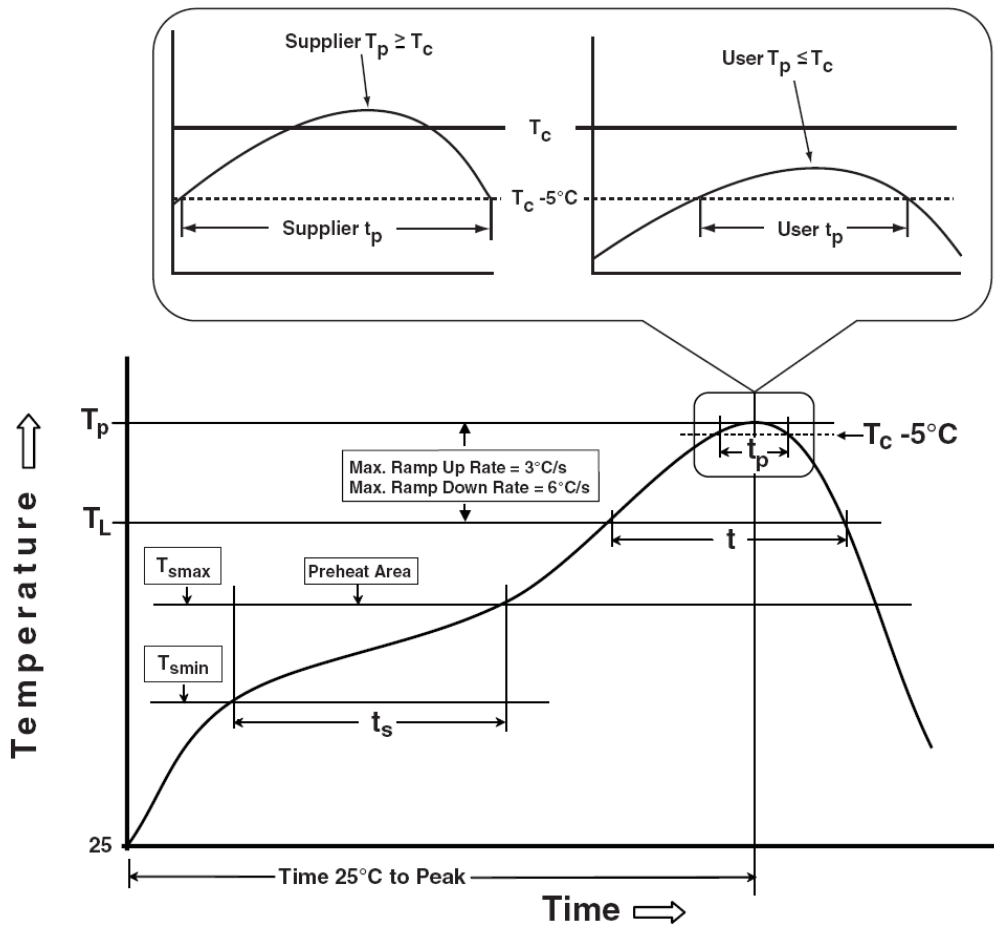

Classification Reflow Profiles

Profile Feature	Sn-Pb Eutectic Assembly	Pb-Free Assembly
Preheat & Soak		
Temperature min (T_{smin})	100 °C	150 °C
Temperature max (T_{smax})	150 °C	200 °C
Time (T_{smin} to T_{smax}) (t_s)	60-120 seconds	60-120 seconds
Average ramp-up rate (T_{smax} to T_p)	3 °C/second max.	3°C/second max.
Liquidous temperature (T_L)	183 °C	217 °C
Time at liquidous (t_L)	60-150 seconds	60-150 seconds
Peak package body Temperature (T_p)*	See Classification Temp in table 1	See Classification Temp in table 2
Time (t_p)** within 5°C of the specified classification temperature (T_c)	20** seconds	30** seconds
Average ramp-down rate (T_p to T_{smax})	6 °C/second max.	6 °C/second max.
Time 25°C to peak temperature	6 minutes max.	8 minutes max.
* Tolerance for peak profile Temperature (T_p) is defined as a supplier minimum and a user maximum.		
** Tolerance for time at peak profile temperature (t_p) is defined as a supplier minimum and a user maximum.		

Table 1. SnPb Eutectic Process – Classification Temperatures (T_c)

Package Thickness	Volume mm ³ <350	Volume mm ³ ≥350
<2.5 mm	235 °C	220 °C
≥2.5 mm	220 °C	220 °C

Table 2. Pb-free Process – Classification Temperatures (T_c)

Package Thickness	Volume mm ³ <350	Volume mm ³ 350-2000	Volume mm ³ >2000
<1.6 mm	260 °C	260 °C	260 °C
1.6 mm – 2.5 mm	260 °C	250 °C	245 °C
≥2.5 mm	250 °C	245 °C	245 °C

Reliability Test Program

Test item	Method	Description
SOLDERABILITY	JESD-22, B102	5 Sec, 245°C
HOLT	JESD-22, A108	1000 Hrs, Bias @ 125°C
PCT	JESD-22, A102	168 Hrs, 100%RH, 2atm, 121°C
TCT	JESD-22, A104	500 Cycles, -65°C~150°C
HBM	MIL-STD-883-3015.7	VHBM 2KV
MM	JESD-22, A115	VMM 200V
Latch-Up	JESD 78	10ms, 1 _{tr} 100mA

Customer Service

Anpec Electronics Corp.

Head Office :

No.6, Dusing 1st Road, SBIP,
Hsin-Chu, Taiwan, R.O.C.

Tel : 886-3-5642000

Fax : 886-3-5642050

Taipei Branch :

2F, No. 11, Lane 218, Sec 2 Jhongsing Rd.,
Sindian City, Taipei County 23146, Taiwan

Tel : 886-2-2910-3838

Fax : 886-2-2917-3838