

# RC4560

## Wide-Bandwidth Dual Operational Amplifier

### Features

- Unity gain bandwidth ( $A_v = 1$ ) — 10 MHz
- Slew rate — 4.0V/ $\mu$ S
- Noise voltage at 1 kHz — 7.0nV/ $\sqrt{\text{Hz}}$
- Noise voltage current at 1 kHz — 0.4pA/ $\sqrt{\text{Hz}}$
- $\pm 10\text{V}$  Output into 400 $\Omega$  loads ( $\pm 25\text{mA}$ )
- Supply current per amplifier — 1.8mA
- Input offset voltage — 2.0mV
- Input offset current — 5.0nA
- Unity gain frequency compensated
- Output short circuit protected

### Description

The RC4560 integrated circuit is a high-gain, wide-bandwidth, dual operational amplifier capable of driving 20V peak-to-peak into 400 $\Omega$  loads. The RC4560 combines many of the features of the RC4558 as well as providing the capability of wider bandwidth, and higher slew rate make the RC4560 ideal for active filters, data and telecommunication applications, and many instrumentation applications. The availability of the RC4560 in the surface mounted SOIC package allows it to be used in critical applications requiring very high packing densities.

### Schematic Diagram (1/2 Shown)

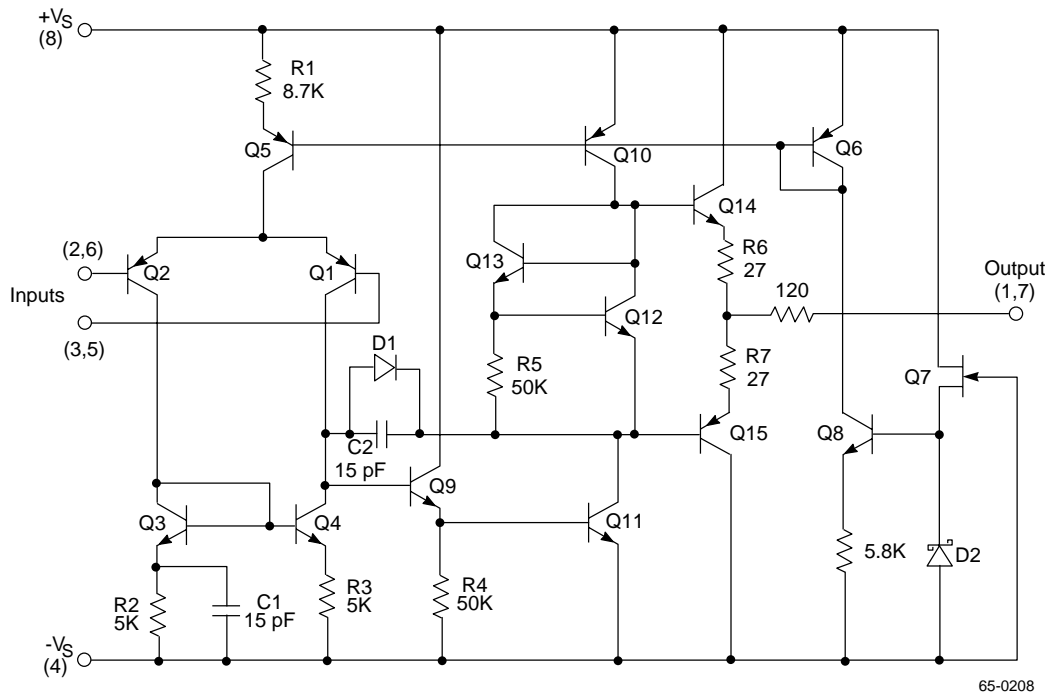

## Pin Assignments

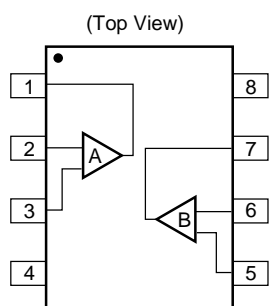

## Pin Descriptions

Pin	Function
1	A Output
2	A -Input
3	A +Input
4	+Vs
5	B +Input
6	B -Input
7	B Output
8	-Vs

## Thermal Characteristics

	SOIC	Plastic DIP
Max. Junction Temp.	125°C	125°C
Max. $P_{DTA} < 50^{\circ}\text{C}$	300mW	468mW
Therm. Res. $\theta_{JC}$	—	—
Therm. Res. $\theta_{JA}$	240°C/W	160°C/W
For $T_A > 50^{\circ}\text{C}$ Derate at	4.17mW/°C	6.25mW/°C

## Absolute Maximum Ratings

(beyond which the device may be damaged)

Parameter	Max.	
Supply Voltage	$\pm 18\text{V}$	
Input Voltage <sup>1</sup>	$\pm 15\text{V}$	
Differential Input Voltage	30V	
Output Short Circuit Duration <sup>2</sup>	Indefinite	
Operating Temperature Range	$-20^{\circ}\text{C}$ to $+75^{\circ}\text{C}$	
Lead Soldering Temperature	RC4560N	+300°C
	RC4560M	+260°C

### Notes:

- For supply voltages less than  $\pm 15\text{V}$ , the absolute maximum input voltage is equal to the supply voltage.
- Short circuit may be to ground on one amp only. Rating applies to  $+75^{\circ}\text{C}$  ambient temperature.

## Matching Characteristics

( $V_S = \pm 15\text{V}$ ,  $T_A = +25^{\circ}\text{C}$ )

Parameter	Conditions	Typ.	Units
Voltage Gain	$R_L \geq 2 \text{ k}\Omega$	$\pm 1.0$	dB
Input Bias Current		$\pm 15$	nA
Input Offset Current		$\pm 7.5$	nA
Input Offset Voltage	$R_S \geq 10 \text{ k}\Omega$	$\pm 0.2$	mV

## Electrical Characteristics

( $V_S = \pm 15V$  and  $T_A = +25^\circ C$  unless otherwise specified)

Parameters	Test Conditions	Min.	Typ.	Max.	Units
Input Offset Voltage	$R_S \leq 10k\Omega$		2.0	6.0	mV
Input Offset Current			5.0	200	nA
Input Bias Current			50	500	nA
Input Resistance (Differential Mode)		0.3	0.1		M $\Omega$
Large Signal Voltage Gain	$R_L \geq 2k\Omega$ , $V_{OUT} = \pm 10V$	20	300		V/mV
Output Voltage Swing	$R_L \geq 10k\Omega$	$\pm 12$	$\pm 14$		V
	$I_O \geq 25mA$	$\pm 10$	$\pm 11.5$		
Input Voltage Range		$\pm 12$	$\pm 13$		V
Common Mode Rejection Ratio	$R_S \leq 10k\Omega$	70	90		dB
Power Supply Rejection Ratio	$R_S \leq 10k\Omega$	76	90		dB
Power Consumption	$R_L = \infty$		135	200	mW
Transient Response	Rise Time	$V_{IN} = 20mV$ , $R_L = 2k\Omega$	0.05		$\mu S$
	Overshoot	$C_L \leq 100pF$	35		%
Slew Rate	$R_L \leq 2k\Omega$ , Gain = 1		4.0		V/ $\mu S$
Channel Separation	$f = 10kHz$ $R_S = 1k\Omega$ , Gain = 100		100		dB
Unity Gain Bandwidth	$A_V = +1$ , $V_O = -3dB$		10		MHz
<b>The following specifications apply for <math>-20^\circ C \leq T_A \leq +75^\circ C</math></b>					
Input Offset Voltage	$R_S \leq 10k\Omega$			7.0	mV
Input Offset Current				300	nA
Input Bias Current				800	nA
Large Signal Voltage Gain	$R_L \geq 2k\Omega$ , $V_{OUT} = \pm 10V$	15			V/mV
Output Voltage Swing	$R_L \geq 2k\Omega$	$\pm 10$			V
Power Consumption	$T_A = +75^\circ C$		135	200	mW
	$T_A = -20^\circ C$		165	230	

### Typical Performance Characteristics

**Input Bias Current vs. Ambient Temperature**

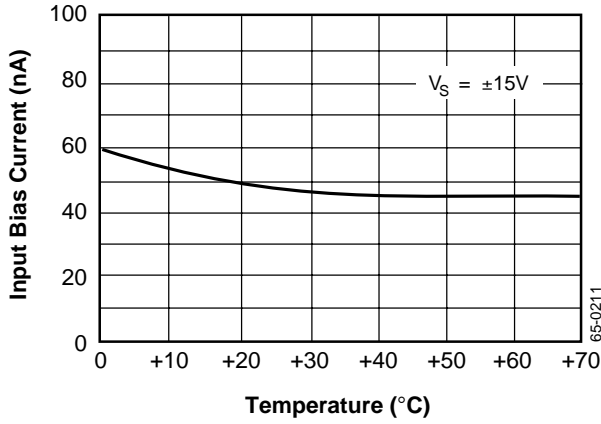

**Input Offset Current vs. Ambient Temperature**

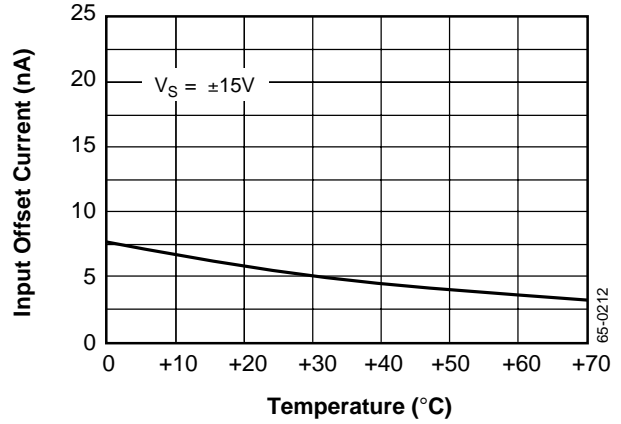

**Common Mode Range vs. Supply Voltage**

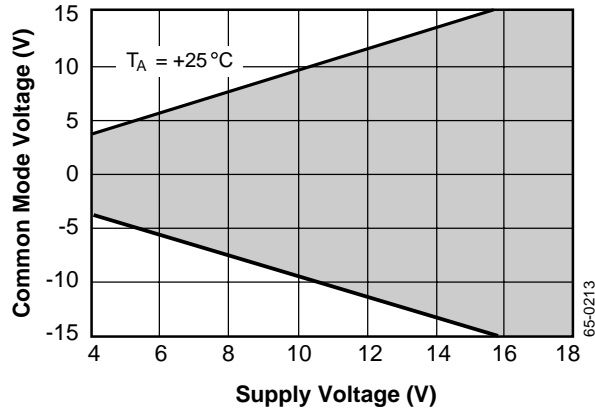

**Open Loop Voltage Gain vs. Frequency**

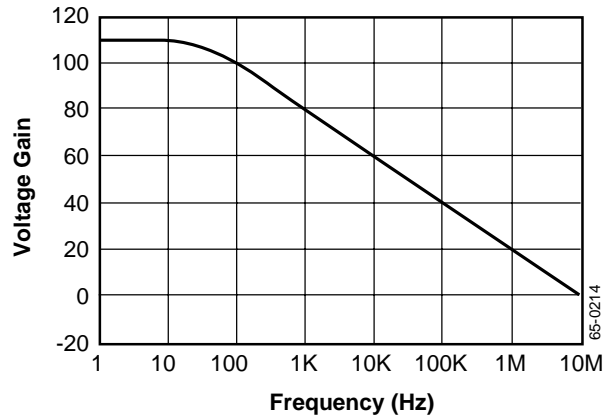

**Open Loop Gain vs. Temperature**

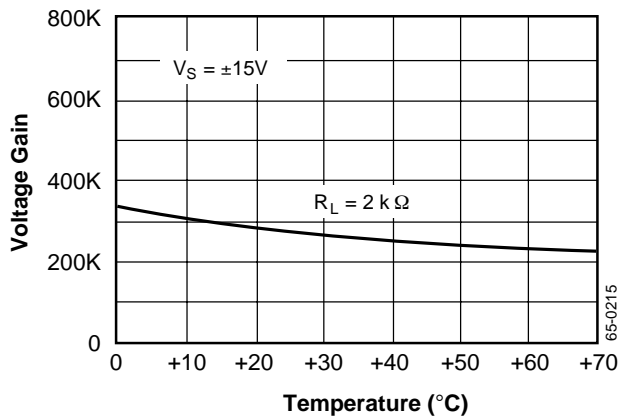

**Power Consumption vs. Ambient Temperature**

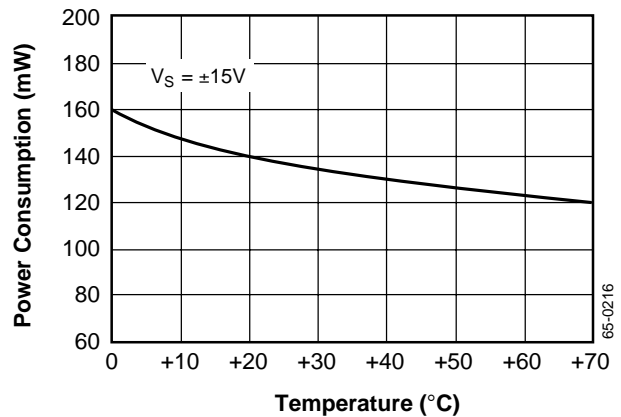

Typical Performance Characteristics (continued)

Typical Output Voltage vs. Supply Voltage

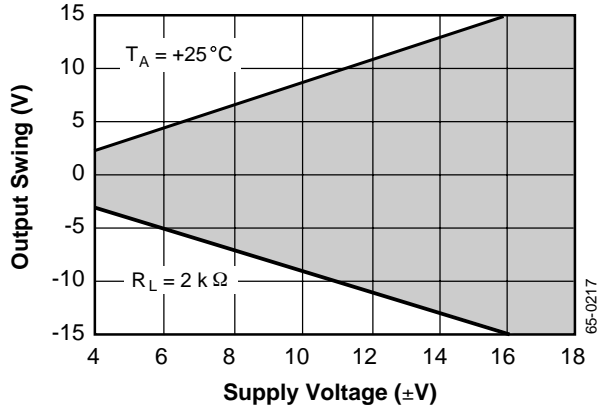

Output Voltage Swing vs. Load Resistance

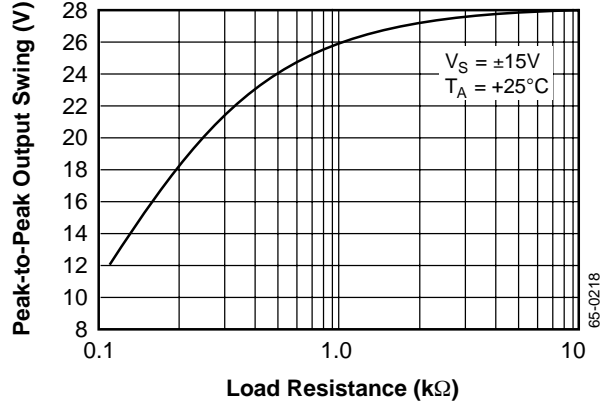

Output Voltage vs. Frequency

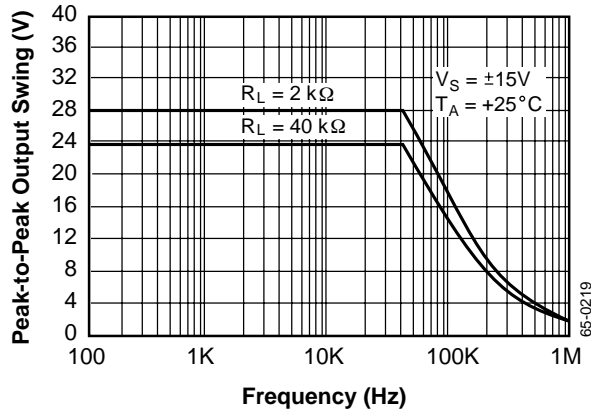

Quiescent Current vs. Supply Voltage

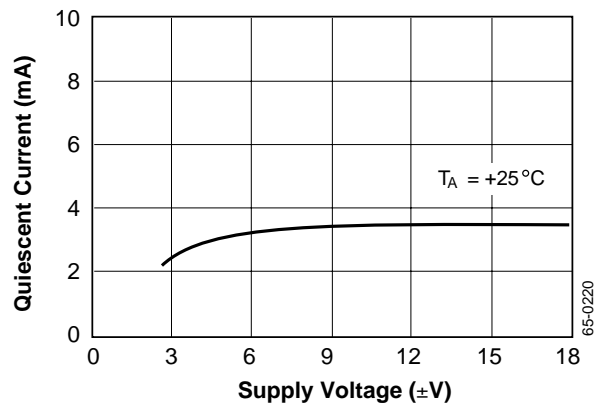

Transient Response

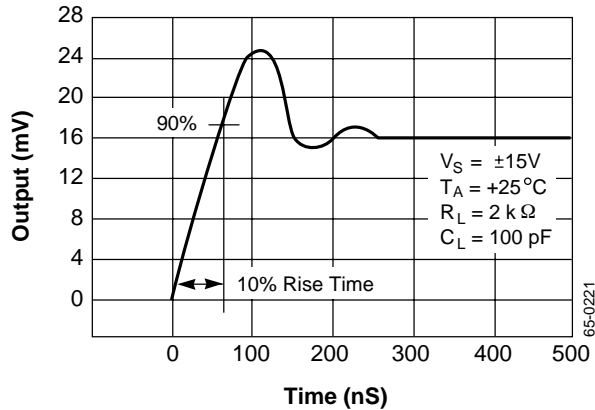

Voltage Follower Large Signal Pulse Response

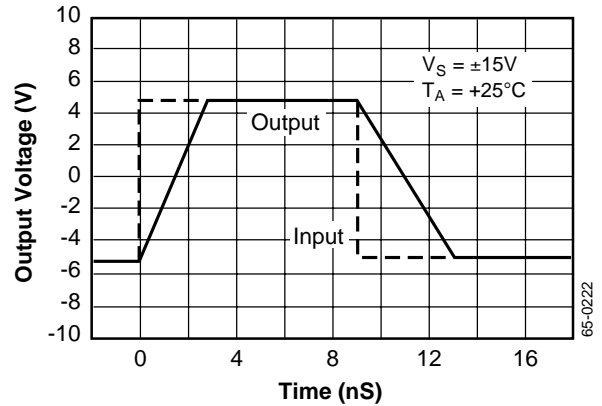

Typical Performance Characteristics (continued)

Input Noise Voltage vs. Frequency

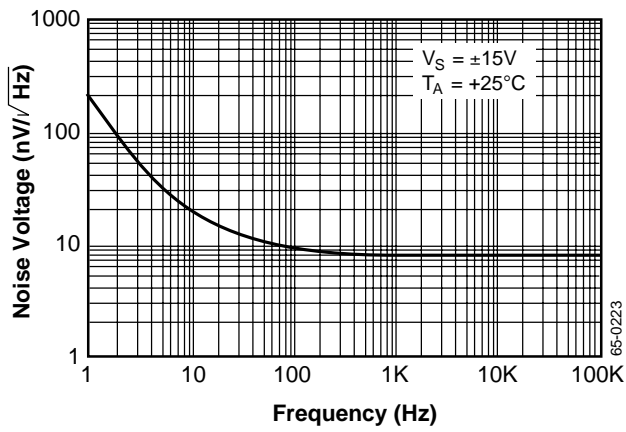

Input Noise Current vs. of Frequency

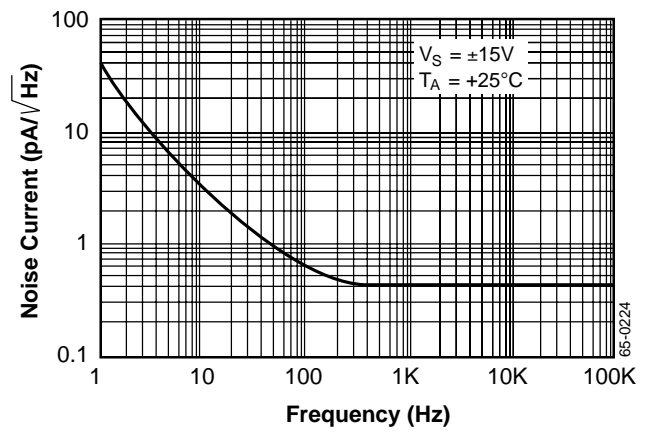

Channel Separation

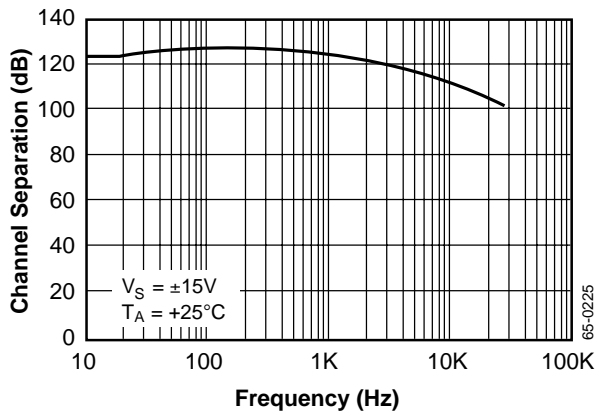

Total Harmonic Distortion vs. Output Voltage

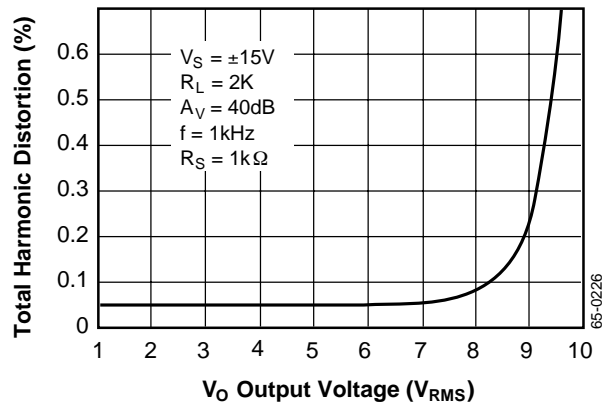

Distortion vs. Frequency

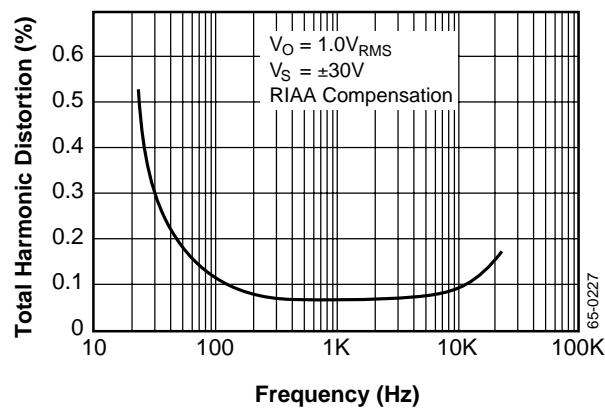

# Notes

# Notes



# Notes

### Mechanical Dimensions

Symbol	Inches		Millimeters		Notes
	Min.	Max.	Min.	Max.	
A	.053	.069	1.35	1.75	
A1	.004	.010	0.10	0.25	
B	.013	.020	0.33	0.51	
C	.008	.010	0.20	0.25	5
D	.189	.197	4.80	5.00	2
E	.150	.158	3.81	4.01	2
e	.050 BSC		1.27 BSC		
H	.228	.244	5.79	6.20	
h	.010	.020	0.25	0.50	
L	.016	.050	0.40	1.27	3
N	8		8		6
$\alpha$	0°	8°	0°	8°	
ccc	—	.004	—	0.10	

**Notes:**

1. Dimensioning and tolerancing per ANSI Y14.5M-1982.
2. "D" and "E" do not include mold flash. Mold flash or protrusions shall not exceed .010 inch (0.25mm).
3. "L" is the length of terminal for soldering to a substrate.
4. Terminal numbers are shown for reference only.
5. "C" dimension does not include solder finish thickness.
6. Symbol "N" is the maximum number of terminals.

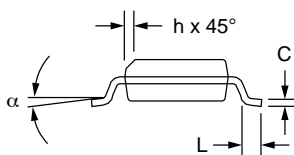
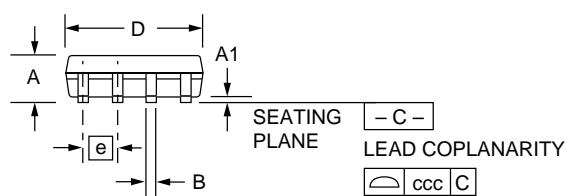
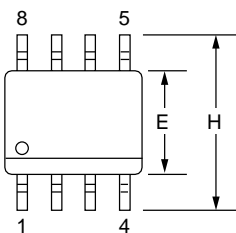

# Mechanical Dimensions

## 8-Lead Plastic DIP Package

Symbol	Inches		Millimeters		Notes
	Min.	Max.	Min.	Max.	
A	—	.210	—	5.33	
A1	.015	—	.38	—	
A2	.115	.195	2.93	4.95	
B	.014	.022	.36	.56	
B1	.045	.070	1.14	1.78	
C	.008	.015	.20	.38	4
D	.348	.430	8.84	10.92	2
D1	.005	—	.13	—	
E	.300	.325	7.62	8.26	
E1	.240	.280	6.10	7.11	2
e	.100 BSC		2.54 BSC		
eB	—	.430	—	10.92	
L	.115	.160	2.92	4.06	
N	8°		8°		5

**Notes:**

1. Dimensioning and tolerancing per ANSI Y14.5M-1982.
2. "D" and "E1" do not include mold flashing. Mold flash or protrusions shall not exceed .010 inch (0.25mm).
3. Terminal numbers are for reference only.
4. "C" dimension does not include solder finish thickness.
5. Symbol "N" is the maximum number of terminals.

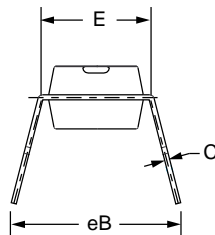
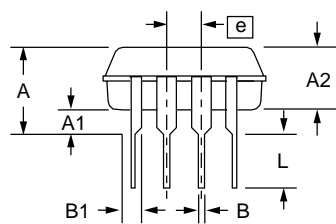
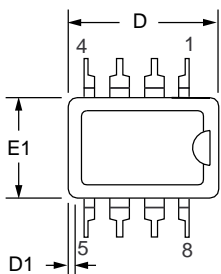

## Ordering Information

Product Number	Temperature Range	Package
RC4560M	-20° to +75°C	8-Lead SOIC
RC4560N	-20° to +75°C	8-Lead Plastic DIP

### LIFE SUPPORT POLICY

FAIRCHILD'S PRODUCTS ARE NOT AUTHORIZED FOR USE AS CRITICAL COMPONENTS IN LIFE SUPPORT DEVICES OR SYSTEMS WITHOUT THE EXPRESS WRITTEN APPROVAL OF THE PRESIDENT OF FAIRCHILD SEMICONDUCTOR CORPORATION. As used herein:

1. Life support devices or systems are devices or systems which, (a) are intended for surgical implant into the body, or (b) support or sustain life, and (c) whose failure to perform when properly used in accordance with instructions for use provided in the labeling, can be reasonably expected to result in a significant injury of the user.
2. A critical component in any component of a life support device or system whose failure to perform can be reasonably expected to cause the failure of the life support device or system, or to affect its safety or effectiveness.