

D-Subminiatur-Steckverbinder Buchsenleisten, Anforderungsstufe 3

D-Subminiature connectors Socket connectors, Requirements level 3

Buchsenleisten Socket connectors

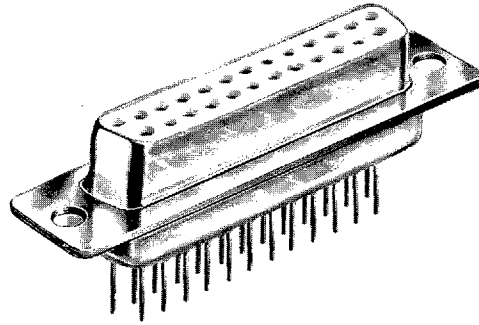

Gehäuserahmen gelb chromatiert und in Lötkech-Ausführung auch verzinkt lieferbar.
Shell yellow chromated as well as solder cup terminal shell tinned available.

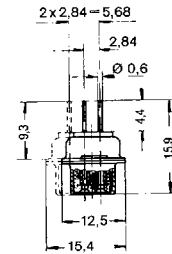
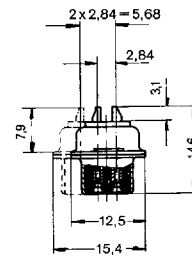
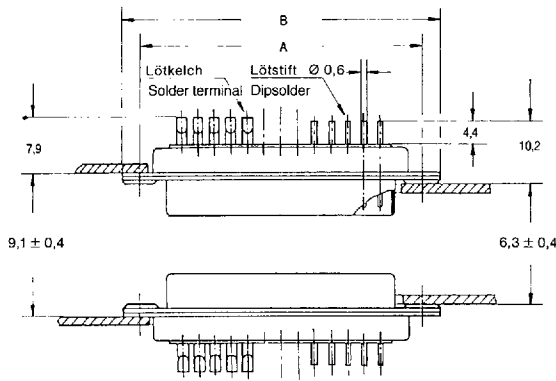

Polzahl No. of contacts	Abmessungen / Dimensions (mm / inch)	
	A	B
9	25,0 / 0.984	30,8 / 1.213
15	33,3 / 1.311	39,2 / 1.543
19	38,9 / 1.531	45,2 / 1.780
23	44,2 / 1.740	50,4 / 1.984
25	47,0 / 1.850	53,0 / 2.087
37	63,5 / 2.500	69,4 / 2.733
50	61,1 / 2.406	67,0 / 2.638

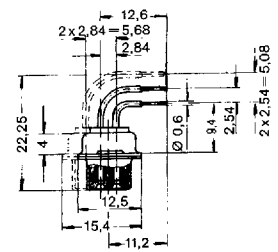

Anschlußarten / Terminal versions

Löt / solder			Tauchlöt / dipsolder	Abgew. / angled	
Gehäuse: gelb chromatiert Shell: yellow chromated	verzinkt tinned	verzinkt tinned	gelb chromatiert yellow chromated	gelb chromatiert yellow chromated	Polzahl No. of contacts
A-DF 09 LL	A-DF 09 LL/Z	A-DF 09 LL/G	A-DF 09 PP	A-DF 09 AA	9
A-DF 15 LL	A-DF 15 LL/Z	A-DF 15 LL/G	A-DF 15 PP	A-DF 15 AA	15
A-DF 19 LL-EDV	—	—	—	—	19
A-DF 23 LL-EDV	—	—	—	—	23
A-DF 25 LL	A-DF 25 LL/Z	A-DF 25 LL/G	A-DF 25 PP	A-DF 25 AA	25
A-DF 37 LL	A-DF 37 LL/Z	A-DF 37 LL/G	A-DF 37 PP	A-DF 37 AA	37
A-DF 50 LL	A-DF 50 LL/Z	A-DF 50 LL/G	A-DF 50 PP	A-DF 50 AA	50
	Kontakte: selektiv veredelt Contacts: selective plating	Kontakte: vergoldet Contacts: gold plating			

D-Subminiatur-Steckverbinder Stiftleisten, Anforderungsstufe 3 D-Subminiature connectors Pin connectors, Requirements level 3

Stiftleisten
Plug connectors

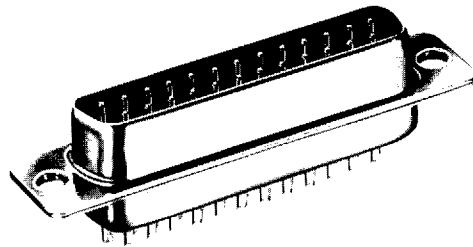

Gehäuserahmen gelb chromatiert und in Lötkelch-Ausführung auch verzinkt und mit Schirmfederung lieferbar.

Shell yellow chromated as well as solder cup terminal tinned and dimpled available.

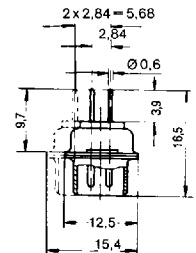
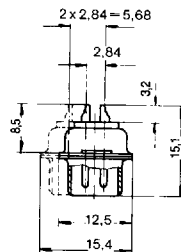
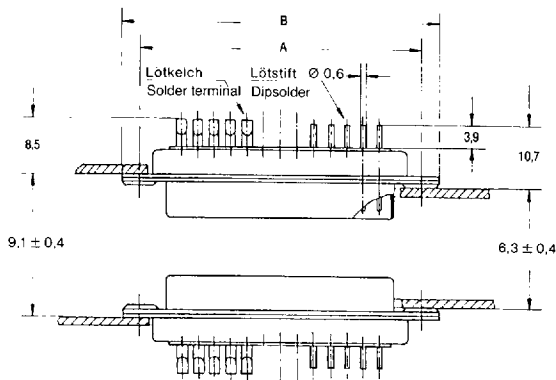



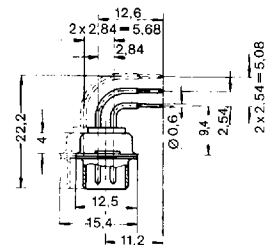

Polzahl No. of contacts	Abmessungen / Dimensions (mm / inch)	
	A	B
9	25,0 / 0.984	30,8 / 1.213
15	33,3 / 1.311	39,2 / 1.543
19	38,9 / 1.531	45,2 / 1.780
23	44,2 / 1.740	50,4 / 1.984
25	47,0 / 1.850	53,0 / 2.087
37	63,5 / 2.500	69,4 / 2.733
50	61,1 / 2.406	67,0 / 2.638

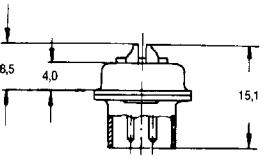

* Selektiv: Lötkelch verzinkt / Solder cup tinned
Kontaktzone vergoldet / Gold plated contact area

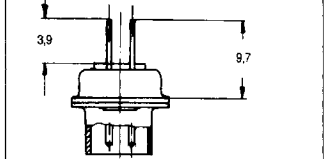
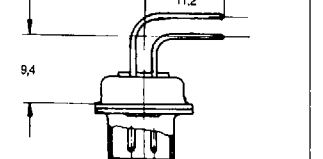
Anschlußarten / Terminal versions

Löt / solder		Tauchlöt / dipsolder		Abgew. / angled	
					Polzahl No. of contacts
Gehäuse: gelb chromatiert Shell: yellow chromated	verzinkt tinned	verzinkt tinned	gelb chromatiert yellow chromated	gelb chromatiert yellow chromated	
A-DS 09 LL	A-DS 09 LL/Z	A-DS 09 LL/G	A-DS 09 PP	A-DS 09 AA	9
A-DS 15 LL	A-DS 15 LL/Z	A-DS 15 LL/G	A-DS 15 PP	A-DS 15 AA	15
A-DS 19 LL-EDV	—	—	—	—	19
A-DS 23 LL-EDV	—	—	—	—	23
A-DS 25 LL	A-DS 25 LL/Z	A-DS 25 LL/G	A-DS 25 PP	A-DS 25 AA	25
A-DS 37 LL	A-DS 37 LL/Z	A-DS 37 LL/G	A-DS 37 PP	A-DS 37 AA	37
A-DS 50 LL	A-DS 50 LL/Z	A-DS 50 LL/G	A-DS 50 PP	A-DS 50 AA	50
	* Kontakte: selektiv veredelt Contacts: selective plating	Kontakte: vergoldet Contacts: gold plating	Kontakte: vergoldet Contacts: gold plating	Kontakte: vergoldet Contacts: gold plating	