



## 1.25mm WAFER RIGHT ANGLE / STRAIGHT TYPE

### SPECIFICATIONS

Current Rating: 1A AC,DC  
Voltage Rating: 100V AC,DC  
Temperature Range:  $-25^{\circ}\text{C} \sim +85^{\circ}\text{C}$   
Contact Resistance: 20m $\Omega$  Max.  
Insulation Resistance: 100M $\Omega$  Min.  
Withstanding Voltage: 500V AC/minute  
Pin Material: Brass/Tin-plated  
Material: Nylon 66,UL94V-0  
Pantone Color: 472C

PART NO.	Dimensions	
	A	B
1251R-02TR-L	1.25	4.25
1251R-03TR-L	2.50	5.50
1251R-04TR-L	3.75	6.75
1251R-05TR-L	5.00	8.00
1251R-06TR-L	6.25	9.25
1251R-07TR-L	7.50	10.50
1251R-08TR-L	8.75	11.75
1251R-09TR-L	10.00	13.00
1251R-10TR-L	11.25	14.25
1251R-11TR-L	12.50	15.50
1251R-12TR-L	13.75	16.75
1251R-13TR-L	15.00	18.00
1251R-14TR-L	16.25	19.25
1251R-15TR-L	17.50	20.50

**Part No.:1251R-XXTR-L**

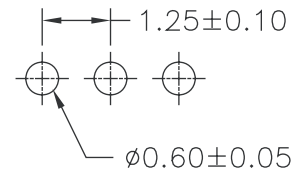
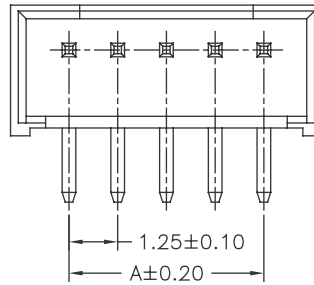
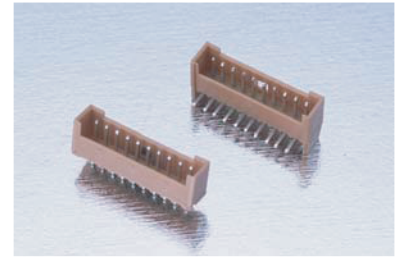

P.C.B. LAYOUT

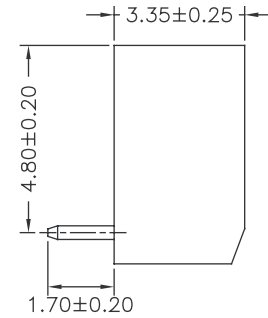
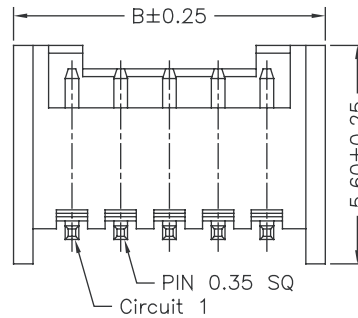

### SPECIFICATIONS

Current Rating: 1A AC,DC  
Voltage Rating: 100V AC,DC  
Temperature Range:  $-25^{\circ}\text{C} \sim +85^{\circ}\text{C}$   
Contact Resistance: 20m $\Omega$  Max.  
Insulation Resistance: 100M $\Omega$  Min.  
Withstanding Voltage: 500V AC/minute  
Pin Material: Brass/Tin-plated  
Material: Nylon 66,UL94V-0  
Pantone Color: 472C

PART NO.	Dimensions	
	A	B
1251S-02TR-L	1.25	4.25
1251S-03TR-L	2.50	5.50
1251S-04TR-L	3.75	6.75
1251S-05TR-L	5.00	8.00
1251S-06TR-L	6.25	9.25
1251S-07TR-L	7.50	10.50
1251S-08TR-L	8.75	11.75
1251S-09TR-L	10.00	13.00
1251S-10TR-L	11.25	14.25
1251S-11TR-L	12.50	15.50
1251S-12TR-L	13.75	16.75
1251S-13TR-L	15.00	18.00
1251S-14TR-L	16.25	19.25
1251S-15TR-L	17.50	20.50

**Part No.:1251S-XXTR-L**

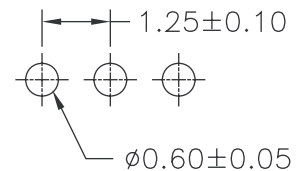
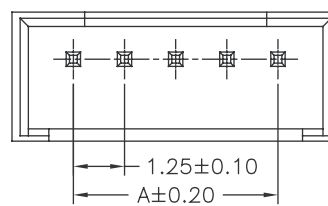

P.C.B. LAYOUT

