

## SNx4HC05 Hex Inverters with Open-Drain Outputs

### 1 Features

- Buffered inputs
- Wide operating voltage range: 2 V to 6 V
- Wide operating temperature range:  $-40^{\circ}\text{C}$  to  $+85^{\circ}\text{C}$
- Supports fanout up to 10 LSTTL loads
- Significant power reduction compared to LSTTL logic ICs

### 2 Applications

- [Synchronize inverted clock inputs](#)
- Invert a digital signal

### 3 Description

This device contains six independent inverters with open-drain outputs. Each gate performs the Boolean function  $Y = \bar{A}$  in positive logic.

#### Device Information<sup>(1)</sup>

| PART NUMBER | PACKAGE    | BODY SIZE (NOM)    |
|-------------|------------|--------------------|
| SN74HC05DR  | SOIC (14)  | 8.70 mm × 3.90 mm  |
| SN74HC05NR  | PDIP (14)  | 19.30 mm × 6.40 mm |
| SN74HC05NSR | SO (14)    | 10.20 mm × 5.30 mm |
| SN74HC05PWR | TSSOP (14) | 5.00 mm × 4.40 mm  |
| SN54HC05JR  | CDIP (14)  | 21.30 mm × 7.60 mm |
| SN54HC05FKR | LCCC (20)  | 8.90 mm × 8.90 mm  |

(1) For all available packages, see the orderable addendum at the end of the data sheet.

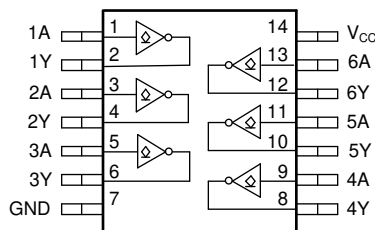

**Functional pinout**



## Table of Contents

|  |   |  |    |
|--|---|--|----|
| <b>1 Features</b> .....                          | 1 | 8.1 Overview.....  | 9  |
| <b>2 Applications</b> .....                      | 1 | 8.2 Functional Block Diagram.....                                | 9  |
| <b>3 Description</b> .....                       | 1 | 8.3 Feature Description.....                                     | 9  |
| <b>4 Revision History</b> .....                  | 2 | 8.4 Device Functional Modes.....                                 | 10 |
| <b>5 Pin Configuration and Functions</b> .....   | 3 | <b>9 Application and Implementation</b> .....                    | 11 |
| Pin Functions.....                               | 3 | 9.1 Application Information.....                                 | 11 |
| <b>6 Specifications</b> .....                    | 4 | 9.2 Typical Application.....                                     | 11 |
| 6.1 Absolute Maximum Ratings.....                | 4 | <b>10 Power Supply Recommendations</b> .....                     | 13 |
| 6.2 ESD Ratings.....                             | 4 | <b>11 Layout</b> .....   | 13 |
| 6.3 Recommended Operating Conditions.....        | 4 | 11.1 Layout Guidelines.....                                      | 13 |
| 6.4 Thermal Information.....                     | 5 | 11.2 Layout Example.....   | 13 |
| 6.5 Electrical Characteristics - 74.....         | 5 | <b>12 Device and Documentation Support</b> .....                 | 14 |
| 6.6 Electrical Characteristics - 54.....         | 5 | 12.1 Documentation Support.....                                  | 14 |
| 6.7 Switching Characteristics - 74.....          | 6 | 12.2 Support Resources.....                                      | 14 |
| 6.8 Switching Characteristics - 54.....          | 6 | 12.3 Trademarks.....   | 14 |
| 6.9 Operating Characteristics.....               | 7 | 12.4 Electrostatic Discharge Caution.....                        | 14 |
| 6.10 Typical Characteristics.....                | 7 | 12.5 Glossary.....   | 14 |
| <b>7 Parameter Measurement Information</b> ..... | 8 | <b>13 Mechanical, Packaging, and Orderable Information</b> ..... | 14 |
| <b>8 Detailed Description</b> .....              | 9 |  |    |

## 4 Revision History

NOTE: Page numbers for previous revisions may differ from page numbers in the current version.

| <b>Changes from Revision E (March 2015) to Revision F (April 2021)</b>                                | <b>Page</b> |
|---|-------------|
| • Updated the numbering format for tables, figures, and cross-references throughout the document..... | 1           |
| • Updated to new data sheet standards.....  | 1           |
| • $R_{\theta JA}$ increased for the D, NS, and PW packages and decreased for the N package.....       | 5           |

---

| <b>Changes from Revision D (August 2003) to Revision E (March 2015)</b>  | <b>Page</b> |
|--|-------------|
| • Added <i>Pin Configuration and Functions</i> section, <i>ESD Ratings</i> table, <i>Feature Description</i> section, <i>Device Functional Modes</i> , <i>Application and Implementation</i> section, <i>Power Supply Recommendations</i> section, <i>Layout</i> section, <i>Device and Documentation Support</i> section, and <i>Mechanical, Packaging, and Orderable Information</i> section ..... | 1           |

## 5 Pin Configuration and Functions



**Figure 5-1. D, N, NS, PW, or J Package  
14-Pin SOIC, PDIP, SO, TSSOP, or CDIP  
Top View**



**Figure 5-2. FK Package  
20-Pin LCCC  
Top View**

## Pin Functions

| NAME            | PIN                |                     | I/O    | DESCRIPTION              |
|-----------------|--------------------|---------------------|--------|--------------------------|
|                 | D, N, NS, PW, or J | FK                  |        |                          |
| 1A              | 1                  | 2                   | Input  | Channel 1, Input A       |
| 1Y              | 2                  | 3                   | Output | Channel 1, Output Y      |
| 2A              | 3                  | 4                   | Input  | Channel 2, Input A       |
| 2Y              | 4                  | 6                   | Output | Channel 2, Output Y      |
| 3A              | 5                  | 8                   | Input  | Channel 3, Input A       |
| 3Y              | 6                  | 9                   | Output | Channel 3, Output Y      |
| GND             | 7                  | 10                  | —      | Ground                   |
| 4Y              | 8                  | 12                  | Output | Channel 4, Output Y      |
| 4A              | 9                  | 13                  | Input  | Channel 4, Input A       |
| 5Y              | 10                 | 14                  | Output | Channel 5, Output Y      |
| 5A              | 11                 | 16                  | Input  | Channel 5, Input A       |
| 6Y              | 12                 | 18                  | Output | Channel 6, Output Y      |
| 6A              | 13                 | 19                  | Input  | Channel 6, Input A       |
| V <sub>CC</sub> | 14                 | 20                  | —      | Positive Supply          |
| NC              |                    | 1, 5, 7, 11, 15, 17 | —      | Not internally connected |

## 6 Specifications

### 6.1 Absolute Maximum Ratings

over operating free-air temperature range (unless otherwise noted)<sup>(1)</sup>

|                  |   |  | MIN  | MAX | UNIT |
|------------------|---|--|------|-----|------|
| V <sub>CC</sub>  | Supply voltage                                    |  | -0.5 | 7   | V    |
| I <sub>IK</sub>  | Input clamp current <sup>(2)</sup>                | V <sub>I</sub> < 0 or V <sub>I</sub> > V <sub>CC</sub> |      | ±20 | mA   |
| I <sub>OK</sub>  | Output clamp current <sup>(2)</sup>               | V <sub>O</sub> < 0 or V <sub>O</sub> > V <sub>CC</sub> |      | ±20 | mA   |
| I <sub>O</sub>   | Continuous output current                         | V <sub>O</sub> = 0 to V <sub>CC</sub>                  |      | ±25 | mA   |
|                  | Continuous current through V <sub>CC</sub> or GND |  |      | ±50 | mA   |
| T <sub>J</sub>   | Junction temperature <sup>(3)</sup>               |  |      | 150 | °C   |
| T <sub>stg</sub> | Storage temperature                               |  | -65  | 150 | °C   |

- (1) Stresses beyond those listed under *Absolute Maximum Rating* may cause permanent damage to the device. These are stress ratings only, which do not imply functional operation of the device at these or any other conditions beyond those indicated under *Recommended Operating Condition*. Exposure to absolute-maximum-rated conditions for extended periods may affect device reliability.
- (2) The input and output voltage ratings may be exceeded if the input and output current ratings are observed.
- (3) Guaranteed by design.

### 6.2 ESD Ratings

|                    |                         |  | VALUE | UNIT |
|--------------------|-------------------------|--|-------|------|
| V <sub>(ESD)</sub> | Electrostatic discharge | Human-body model (HBM), per ANSI/ESDA/ JEDEC JS-001 <sup>(1)</sup>             | ±1000 | V    |
|                    |                         | Charged-device model (CDM), per JEDEC specification JESD22-C101 <sup>(2)</sup> | –     |      |

- (1) JEDEC document JEP155 states that 500-V HBM allows safe manufacturing with a standard ESD control process.
- (2) JEDEC document JEP157 states that 250-V CDM allows safe manufacturing with a standard ESD control process.

### 6.3 Recommended Operating Conditions

over operating free-air temperature range (unless otherwise noted)

|                 |                                     |                         | MIN  | NOM | MAX             | UNIT |
|-----------------|-------------------------------------|-------------------------|------|-----|-----------------|------|
| V <sub>CC</sub> | Supply voltage                      |                         | 2    | 5   | 6               | V    |
| V <sub>IH</sub> | High-level input voltage            | V <sub>CC</sub> = 2 V   | 1.5  |     |                 | V    |
|                 |                                     | V <sub>CC</sub> = 4.5 V | 3.15 |     |                 |      |
|                 |                                     | V <sub>CC</sub> = 6 V   | 4.2  |     |                 |      |
| V <sub>IL</sub> | Low-level input voltage             | V <sub>CC</sub> = 2 V   |      |     | 0.5             | V    |
|                 |                                     | V <sub>CC</sub> = 4.5 V |      |     | 1.35            |      |
|                 |                                     | V <sub>CC</sub> = 6 V   |      |     | 1.8             |      |
| V <sub>I</sub>  | Input voltage                       |                         | 0    |     | V <sub>CC</sub> | V    |
| V <sub>O</sub>  | Output voltage                      |                         | 0    |     | V <sub>CC</sub> | V    |
| Δt/Δv           | Input transition rise and fall rate | V <sub>CC</sub> = 2 V   |      |     | 1000            | ns   |
|                 |                                     | V <sub>CC</sub> = 4.5 V |      |     | 500             |      |
|                 |                                     | V <sub>CC</sub> = 6 V   |      |     | 400             |      |
| T <sub>A</sub>  | Operating free-air temperature      | SN54HC05                | -55  |     | 125             | °C   |
|                 |                                     | SN74HC05                | -40  |     | 125             |      |

## 6.4 Thermal Information

| THERMAL METRIC <sup>(1)</sup> |  | SN74HC05 |          |          |            | UNIT |
|-------------------------------|--|----------|----------|----------|------------|------|
|                               |  | D (SOIC) | N (PDIP) | NS (SOP) | PW (TSSOP) |      |
|                               |  | 14 PINS  | 14 PINS  | 14 PINS  | 14 PINS    |      |
| $R_{\theta JA}$               | Junction-to-ambient thermal resistance       | 133.6    | 62.6     | 122.6    | 151.7      | °C/W |
| $R_{\theta JC(top)}$          | Junction-to-case (top) thermal resistance    | 89.0     | 50.3     | 81.8     | 79.4       | °C/W |
| $R_{\theta JB}$               | Junction-to-board thermal resistance         | 89.5     | 42.3     | 83.8     | 94.7       | °C/W |
| $\Psi_{JT}$                   | Junction-to-top characterization parameter   | 45.5     | 30.0     | 45.4     | 25.2       | °C/W |
| $\Psi_{JB}$                   | Junction-to-board characterization parameter | 89.1     | 42.1     | 83.4     | 94.1       | °C/W |
| $R_{\theta JC(bot)}$          | Junction-to-case (bottom) thermal resistance | N/A      | N/A      | N/A      | N/A        | °C/W |

(1) For more information about traditional and new thermal metrics, see the [Semiconductor and IC Package Thermal Metrics](#) application report.

## 6.5 Electrical Characteristics - 74

over operating free-air temperature range; typical values measured at  $T_A = 25^\circ\text{C}$  (unless otherwise noted).

| PARAMETER | TEST CONDITIONS  | $V_{CC}$                  | Operating free-air temperature ( $T_A$ ) |       |           |               |     |         |                |         |               | UNIT          |
|-----------|--|---------------------------|--|-------|-----------|---------------|-----|---------|----------------|---------|---------------|---------------|
|           |  |                           | 25°C                                     |       |           | -40°C to 85°C |     |         | -40°C to 125°C |         |               |               |
|           |  |                           | MIN                                      | TYP   | MAX       | MIN           | TYP | MAX     | MIN            | TYP     | MAX           |               |
| $I_{OH}$  | Output voltage<br>$V_I = V_{IH}$ or $V_{IL}$           | $V_O = V_{CC}$            | 6 V                                      | 0.01  | 0.5       |               |     | 5       |                |         | 5             | $\mu\text{A}$ |
| $V_{OL}$  | Low-level output voltage<br>$V_I = V_{IH}$ or $V_{IL}$ | $I_{OL} = 20 \mu\text{A}$ | 2 V                                      | 0.002 | 0.1       |               |     | 0.1     |                |         | 0.1           | V             |
|           |  |                           | 4.5 V                                    | 0.001 | 0.1       |               |     | 0.1     |                | 0.1     |               |               |
|           |  |                           | 6 V                                      | 0.001 | 0.1       |               |     | 0.1     |                | 0.1     |               |               |
|           |  |                           | $I_{OL} = 4 \text{ mA}$                  | 4.5 V | 0.17      | 0.26          |     |         | 0.33           |         | 0.33          |               |
|           |  | $I_{OL} = 5.2 \text{ mA}$ | 6 V                                      | 0.15  | 0.26      |               |     | 0.33    |                | 0.33    |               |               |
| $I_I$     | Input leakage current<br>$V_I = V_{CC}$ or 0           |                           | 6 V                                      |       | $\pm 0.1$ |               |     | $\pm 1$ |                | $\pm 1$ | $\mu\text{A}$ |               |
| $I_{CC}$  | Supply current<br>$V_I = V_{CC}$ or 0                  | $I_O = 0$                 | 6 V                                      |       | 2         |               |     | 20      |                | 20      | $\mu\text{A}$ |               |
| $C_i$     | Input capacitance                                      |                           | 2 V to 6 V                               |       | 3         | 10            |     |         |                | 10      | pF            |               |

## 6.6 Electrical Characteristics - 54

over operating free-air temperature range; typical values measured at  $T_A = 25^\circ\text{C}$  (unless otherwise noted).

| PARAMETER | TEST CONDITIONS                              | $V_{CC}$       | Operating free-air temperature ( $T_A$ ) |      |     |               |     |     |                |     |     | UNIT          |
|-----------|--|----------------|--|------|-----|---------------|-----|-----|----------------|-----|-----|---------------|
|           |  |                | 25°C                                     |      |     | -40°C to 85°C |     |     | -55°C to 125°C |     |     |               |
|           |  |                | MIN                                      | TYP  | MAX | MIN           | TYP | MAX | MIN            | TYP | MAX |               |
| $I_{OH}$  | Output voltage<br>$V_I = V_{IH}$ or $V_{IL}$ | $V_O = V_{CC}$ | 6 V                                      | 0.01 | 0.5 |               |     | 5   |                |     | 10  | $\mu\text{A}$ |

over operating free-air temperature range; typical values measured at TA = 25°C (unless otherwise noted).

| PARAMETER       | TEST CONDITIONS          | V <sub>CC</sub>                                     | Operating free-air temperature (T <sub>A</sub> ) |                        |       |               |      |     |                |      |     | UNIT |
|-----------------|--------------------------|---|--|------------------------|-------|---------------|------|-----|----------------|------|-----|------|
|                 |                          |   | 25°C   |                        |       | –40°C to 85°C |      |     | –55°C to 125°C |      |     |      |
|                 |                          |   | MIN  | TYP                    | MAX   | MIN           | TYP  | MAX | MIN            | TYP  | MAX |      |
| V <sub>OL</sub> | Low-level output voltage | V <sub>I</sub> = V <sub>IH</sub> or V <sub>IL</sub> | I <sub>OL</sub> = 20 μA                          | 2 V                    | 0.002 | 0.1           |      |     | 0.1            |      | 0.1 | V    |
|                 |                          |   |  | 4.5 V                  | 0.001 | 0.1           |      |     | 0.1            | 0.1  |     |      |
|                 |                          |   |  | 6 V                    | 0.001 | 0.1           |      |     | 0.1            | 0.1  |     |      |
|                 |                          |   |  | I <sub>OL</sub> = 4 mA | 4.5 V | 0.17          | 0.26 |     |                | 0.33 | 0.4 |      |
|                 |                          |   |  |                        | 6 V   | 0.15          | 0.26 |     |                | 0.33 | 0.4 |      |
| I <sub>I</sub>  | Input leakage current    | V <sub>I</sub> = V <sub>CC</sub> or 0               | 6 V  |                        | ±0.1  |               |      | ±1  |                | ±1   | μA  |      |
| I <sub>CC</sub> | Supply current           | V <sub>I</sub> = V <sub>CC</sub> or 0               | I <sub>O</sub> = 0                               | 6 V                    |       | 2             |      |     | 20             |      | 40  | μA   |
| C <sub>i</sub>  | Input capacitance        |   | 2 V to 6 V                                       |                        | 3     | 10            |      |     | 10             |      | 10  | pF   |

## 6.7 Switching Characteristics - 74

over operating free-air temperature range; typical values measured at TA = 25°C (unless otherwise noted).

| PARAMETER        | FROM                          | TO | V <sub>CC</sub> | Operating free-air temperature (T <sub>A</sub> ) |     |     |               |     |     |                |     |     | UNIT |
|------------------|-------------------------------|----|-----------------|--|-----|-----|---------------|-----|-----|----------------|-----|-----|------|
|                  |                               |    |                 | 25°C   |     |     | –40°C to 85°C |     |     | –40°C to 125°C |     |     |      |
|                  |                               |    |                 | MIN  | TYP | MAX | MIN           | TYP | MAX | MIN            | TYP | MAX |      |
| t <sub>PLH</sub> | Propagation delay low-to-high | A  | Y               | 2 V  | 60  | 115 |               |     | 145 |                | 160 | ns  |      |
|                  |                               |    |                 | 4.5 V  | 13  | 23  |               |     | 29  | 31             |     |     |      |
|                  |                               |    |                 | 6 V  | 10  | 20  |               |     | 25  | 28             |     |     |      |
| t <sub>PHL</sub> | Propagation delay high-to-low | A  | Y               | 2 V  | 45  | 85  |               |     | 105 |                | 120 | ns  |      |
|                  |                               |    |                 | 4.5 V  | 9   | 17  |               |     | 21  | 23             |     |     |      |
|                  |                               |    |                 | 6 V  | 8   | 14  |               |     | 18  | 21             |     |     |      |
| t <sub>t</sub>   | Transition-time               |    | Y               | 2 V  | 38  | 75  |               |     | 95  |                | 110 | ns  |      |
|                  |                               |    |                 | 4.5 V  | 8   | 15  |               |     | 19  | 22             |     |     |      |
|                  |                               |    |                 | 6 V  | 6   | 13  |               |     | 16  | 19             |     |     |      |

## 6.8 Switching Characteristics - 54

over operating free-air temperature range; typical values measured at TA = 25°C (unless otherwise noted).

| PARAMETER        | FROM                          | TO | V <sub>CC</sub> | Operating free-air temperature (T <sub>A</sub> ) |     |     |               |     |     |                |     |     | UNIT |
|------------------|-------------------------------|----|-----------------|--|-----|-----|---------------|-----|-----|----------------|-----|-----|------|
|                  |                               |    |                 | 25°C   |     |     | –40°C to 85°C |     |     | –55°C to 125°C |     |     |      |
|                  |                               |    |                 | MIN  | TYP | MAX | MIN           | TYP | MAX | MIN            | TYP | MAX |      |
| t <sub>PLH</sub> | Propagation delay low-to-high | A  | Y               | 2 V  | 60  | 115 |               |     | 145 |                | 175 | ns  |      |
|                  |                               |    |                 | 4.5 V  | 13  | 23  |               |     | 29  | 35             |     |     |      |
|                  |                               |    |                 | 6 V  | 10  | 20  |               |     | 25  | 30             |     |     |      |
| t <sub>PHL</sub> | Propagation delay high-to-low | A  |                 | 2 V  | 45  | 85  |               |     | 105 |                | 130 | ns  |      |
|                  |                               |    |                 | 4.5 V  | 9   | 17  |               |     | 21  | 26             |     |     |      |
|                  |                               |    |                 | 6 V  | 8   | 14  |               |     | 18  | 22             |     |     |      |
| t <sub>t</sub>   | Transition-time               |    | Y               | 2 V  | 38  | 75  |               |     | 95  |                | 110 | ns  |      |
|                  |                               |    |                 | 4.5 V  | 8   | 15  |               |     | 19  | 22             |     |     |      |
|                  |                               |    |                 | 6 V  | 6   | 13  |               |     | 16  | 19             |     |     |      |

### 6.9 Operating Characteristics

over operating free-air temperature range; typical values measured at  $T_A = 25^\circ\text{C}$  (unless otherwise noted).

| PARAMETER |  | TEST CONDITIONS | $V_{CC}$   | MIN | TYP | MAX | UNIT |
|-----------|--|-----------------|------------|-----|-----|-----|------|
| $C_{pd}$  | Power dissipation capacitance per gate | No load         | 2 V to 6 V |     | 20  |     | pF   |

### 6.10 Typical Characteristics

$T_A = 25^\circ\text{C}$

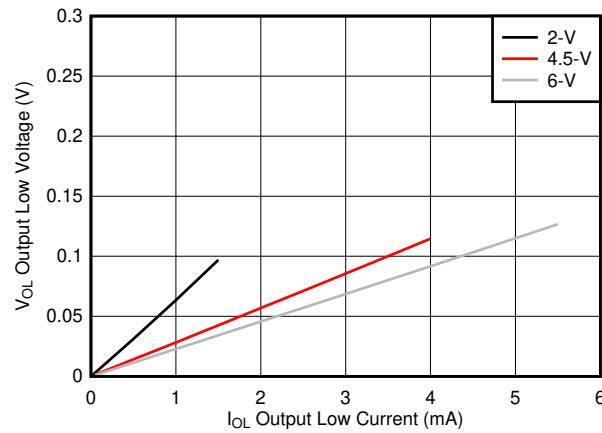

**Figure 6-1. Typical output voltage in the low state ( $V_{OL}$ )**

## 7 Parameter Measurement Information

- Phase relationships between waveforms were chosen arbitrarily. All input pulses are supplied by generators having the following characteristics:  $PRR \leq 1$  MHz,  $Z_O = 50 \Omega$ ,  $t_t < 6$  ns.
- The outputs are measured one at a time, with one input transition per measurement.

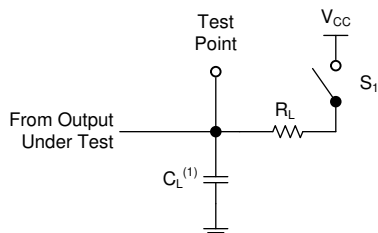

A.  $C_L = 50$  pF and includes probe and jig capacitance.

**Figure 7-1. Load Circuit**



A.  $t_t$  is the greater of  $t_r$  and  $t_f$ .

**Figure 7-2. Voltage Waveforms Transition Times**

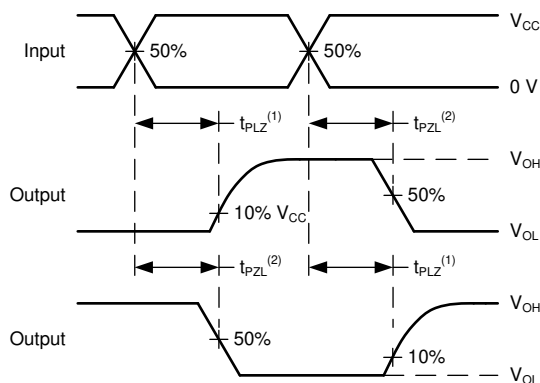

A. The maximum between  $t_{PLH}$  and  $t_{PHL}$  is used for  $t_{pd}$ .

**Figure 7-3. Voltage Waveforms Propagation Delays**



## 8 Detailed Description

### 8.1 Overview

This device contains six independent inverters with open-drain outputs. Each gate performs the Boolean function  $Y = \bar{A}$  in positive logic.

### 8.2 Functional Block Diagram

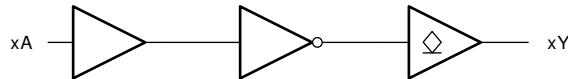

### 8.3 Feature Description

#### 8.3.1 CMOS Open-Drain Outputs

The open-drain output allows the device to sink current to GND but not to source current from  $V_{CC}$ . When the output is not actively pulling the line low, it will go into a high impedance state. This allows the device to be used for a wide variety of applications, including up-translation and down-translation, as the output voltage can be determined by an external pull-up resistor.

The current drive capability of this device creates fast edges into light loads, so routing and load conditions should be considered to prevent ringing. Additionally, the outputs of this device are capable of driving larger currents than the device can sustain without being damaged. It is important for the power output of the device to be limited to avoid thermal runaway and damage due to over-current. The electrical and thermal limits defined in the [Absolute Maximum Ratings](#) must be followed at all times.

The SN74HC05 can drive a load with a total capacitance less than or equal to the maximum load listed in the [Switching Characteristics - 74](#) connected to a high-impedance CMOS input while still meeting all of the datasheet specifications. Larger capacitive loads can be applied, however it is not recommended to exceed the provided load value. If larger capacitive loads are required, it is recommended to add a series resistor between the output and the capacitor to limit output current to the values given in the [Absolute Maximum Ratings](#).

#### 8.3.2 Standard CMOS Inputs

Standard CMOS inputs are high impedance and are typically modeled as a resistor from the input to ground in parallel with the input capacitance given in the [Electrical Characteristics - 74](#). The worst case resistance is calculated with the maximum input voltage, given in the [Absolute Maximum Ratings](#), and the maximum input leakage current, given in the [Electrical Characteristics - 74](#), using ohm's law ( $R = V \div I$ ).

Signals applied to the inputs need to have fast edge rates, as defined by the input transition time in the [Recommended Operating Conditions](#) to avoid excessive current consumption and oscillations. If a slow or noisy input signal is required, a device with a Schmitt-trigger input should be used to condition the input signal prior to the standard CMOS input.

### 8.3.3 Clamp Diode Structure

The inputs and outputs to this device have both positive and negative clamping diodes as depicted in [Figure 8-1](#).

**CAUTION**

Voltages beyond the values specified in the [Absolute Maximum Ratings](#) table can cause damage to the device. The recommended input and output voltage ratings may be exceeded if the input and output clamp-current ratings are observed.



Figure 8-1. Electrical Placement of Clamping Diodes for Each Input and Output

### 8.4 Device Functional Modes

Table 8-1. Function Table

| INPUT | OUTPUT |
|-------|--------|
| A     | Y      |
| L     | Hi-Z   |
| H     | L      |

## 9 Application and Implementation

### Note

Information in the following applications sections is not part of the TI component specification, and TI does not warrant its accuracy or completeness. TI's customers are responsible for determining suitability of components for their purposes, as well as validating and testing their design implementation to confirm system functionality.

### 9.1 Application Information

In this application, one open-drain inverter is used as shown in [Figure 9-1](#). The other five channels can be used for other applications in the system, or the inputs can be grounded and the channels left unused.

This device is used to directly control an LED. The LED is on when the input is high, and off when the input is low.

### 9.2 Typical Application

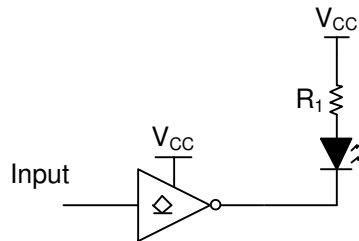

**Figure 9-1. Typical application schematic**

#### 9.2.1 Design Requirements

##### 9.2.1.1 Power Considerations

Ensure the desired supply voltage is within the range specified in the [Recommended Operating Conditions](#). The supply voltage sets the device's electrical characteristics as described in the [Electrical Characteristics - 74](#).

The ground must be capable of sinking current equal to the total current to be sunk by all outputs of the SN74HC05 plus the maximum supply current,  $I_{CC}$ , listed in [Electrical Characteristics - 74](#). The logic device can only sink as much current as is provided by the external pull-up resistor or other supply source. Be sure not to exceed the maximum total current through GND listed in the [Absolute Maximum Ratings](#).

Total power consumption can be calculated using the information provided in [CMOS Power Consumption and  \$C\_{pd}\$  Calculation](#).

Thermal increase can be calculated using the information provided in [Thermal Characteristics of Standard Linear and Logic \(SLL\) Packages and Devices](#).

#### CAUTION

The maximum junction temperature,  $T_{J(max)}$  listed in the [Absolute Maximum Ratings](#), is an *additional limitation* to prevent damage to the device. Do not violate any values listed in the [Absolute Maximum Ratings](#). These limits are provided to prevent damage to the device.

##### 9.2.1.2 Input Considerations

Unused inputs must be terminated to either  $V_{CC}$  or ground. These can be directly terminated if the input is completely unused, or they can be connected with a pull-up or pull-down resistor if the input is to be used sometimes, but not always. A pull-up resistor is used for a default state of HIGH, and a pull-down resistor is used for a default state of LOW. The resistor size is limited by drive current of the controller, leakage current into

the SN74HC05, as specified in the [Electrical Characteristics - 74](#), and the desired input transition rate. A 10-k $\Omega$  resistor value is often used due to these factors.

The SN74HC05 has standard CMOS inputs, so input signal edge rates cannot be slow. Slow input edge rates can cause oscillations and damaging shoot-through current. The recommended rates are defined in the [Recommended Operating Conditions](#).

Refer to [Section 8.3](#) for additional information regarding the inputs for this device.

### 9.2.1.3 Output Considerations

The ground voltage is used to produce the output LOW voltage. Sinking current into the output will increase the output voltage as specified by the  $V_{OL}$  specification in the [Electrical Characteristics - 74](#). The plot in provides a typical relationship between output voltage and current for this device.

Open-drain outputs can be directly connected together to produce a wired-AND. This is possible because the outputs cannot source current, and thus can never be in bus-contention.

Unused outputs can be left floating. Do not connect outputs directly to  $V_{CC}$  or ground.

Refer to [Section 8.3](#) for additional information regarding the outputs for this device.

### 9.2.2 Detailed Design Procedure

1. Add a decoupling capacitor from  $V_{CC}$  to GND. The capacitor needs to be placed physically close to the device and electrically close to both the  $V_{CC}$  and GND pins. An example layout is shown in [Section 11](#).
2. Ensure the capacitive load at the output is  $\leq 70$  pF. This is not a hard limit, however it will ensure optimal performance. This can be accomplished by providing short, appropriately sized traces from the SN74HC05 to the receiving device.
3. Ensure the resistive load at the output is larger than  $(V_{CC} / I_{O(max)}) \Omega$ . This will ensure that the maximum output current from the [Absolute Maximum Ratings](#) is not violated. Most CMOS inputs have a resistive load measured in megaohms; much larger than the minimum calculated above.
4. Thermal issues are rarely a concern for logic gates, however the power consumption and thermal increase can be calculated using the steps provided in the application report, [CMOS Power Consumption and Cpd Calculation](#)

### 9.2.3 Application Curves

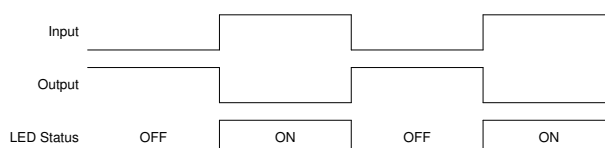

**Figure 9-2. Typical application timing diagram**

## 10 Power Supply Recommendations

The power supply can be any voltage between the minimum and maximum supply voltage rating located in the *Recommended Operating Conditions*. Each  $V_{CC}$  terminal should have a bypass capacitor to prevent power disturbance. A 0.1- $\mu\text{F}$  capacitor is recommended for this device. It is acceptable to parallel multiple bypass caps to reject different frequencies of noise. The 0.1- $\mu\text{F}$  and 1- $\mu\text{F}$  capacitors are commonly used in parallel. The bypass capacitor should be installed as close to the power terminal as possible for best results, as shown in *Figure 11-1*.

## 11 Layout

### 11.1 Layout Guidelines

When using multiple-input and multiple-channel logic devices inputs must not ever be left floating. In many cases, functions or parts of functions of digital logic devices are unused; for example, when only two inputs of a triple-input AND gate are used. Such unused input pins must not be left unconnected because the undefined voltages at the outside connections result in undefined operational states. All unused inputs of digital logic devices must be connected to a logic high or logic low voltage, as defined by the input voltage specifications, to prevent them from floating. The logic level that must be applied to any particular unused input depends on the function of the device. Generally, the inputs are tied to GND or  $V_{CC}$ , whichever makes more sense for the logic function or is more convenient.

### 11.2 Layout Example

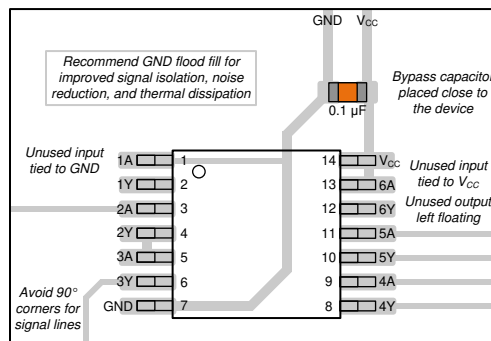

**Figure 11-1. Example layout for the SN74HC05**

## 12 Device and Documentation Support

### 12.1 Documentation Support

#### 12.1.1 Related Documentation

For related documentation see the following:

- [HCMOS Design Considerations](#)
- [CMOS Power Consumption and CPD Calculation](#)
- [Designing with Logic](#)

### 12.2 Support Resources

[TI E2E™ support forums](#) are an engineer's go-to source for fast, verified answers and design help — straight from the experts. Search existing answers or ask your own question to get the quick design help you need.

Linked content is provided "AS IS" by the respective contributors. They do not constitute TI specifications and do not necessarily reflect TI's views; see TI's [Terms of Use](#).

### 12.3 Trademarks

TI E2E™ is a trademark of Texas Instruments.

All trademarks are the property of their respective owners.

### 12.4 Electrostatic Discharge Caution



This integrated circuit can be damaged by ESD. Texas Instruments recommends that all integrated circuits be handled with appropriate precautions. Failure to observe proper handling and installation procedures can cause damage.

ESD damage can range from subtle performance degradation to complete device failure. Precision integrated circuits may be more susceptible to damage because very small parametric changes could cause the device not to meet its published specifications.

### 12.5 Glossary

[TI Glossary](#) This glossary lists and explains terms, acronyms, and definitions.

## 13 Mechanical, Packaging, and Orderable Information

The following pages include mechanical, packaging, and orderable information. This information is the most current data available for the designated devices. This data is subject to change without notice and revision of this document. For browser-based versions of this data sheet, refer to the left-hand navigation.

**PACKAGING INFORMATION**

| Orderable Device | Status<br>(1) | Package Type | Package Drawing | Pins | Package Qty | Eco Plan<br>(2)  | Lead finish/<br>Ball material<br>(6) | MSL Peak Temp<br>(3) | Op Temp (°C) | Device Marking<br>(4/5)       | Samples |
|------------------|---------------|--------------|-----------------|------|-------------|------------------|--------------------------------------|----------------------|--------------|-------------------------------|---------|
| 5962-88718012A   | ACTIVE        | LCCC         | FK              | 20   | 55          | Non-RoHS & Green | SNPB                                 | N / A for Pkg Type   | -55 to 125   | 5962-88718012A<br>SNJ54HC05FK | Samples |
| 5962-8871801CA   | ACTIVE        | CDIP         | J               | 14   | 25          | Non-RoHS & Green | SNPB                                 | N / A for Pkg Type   | -55 to 125   | 5962-8871801CA<br>SNJ54HC05J  | Samples |
| SN54HC05J        | ACTIVE        | CDIP         | J               | 14   | 25          | Non-RoHS & Green | SNPB                                 | N / A for Pkg Type   | -55 to 125   | SN54HC05J                     | Samples |
| SN74HC05DR       | ACTIVE        | SOIC         | D               | 14   | 2500        | RoHS & Green     | NIPDAU   SN                          | Level-1-260C-UNLIM   | -40 to 125   | HC05                          | Samples |
| SN74HC05DRG4     | ACTIVE        | SOIC         | D               | 14   | 2500        | RoHS & Green     | NIPDAU                               | Level-1-260C-UNLIM   | -40 to 125   | HC05                          | Samples |
| SN74HC05N        | ACTIVE        | PDIP         | N               | 14   | 25          | RoHS & Green     | NIPDAU                               | N / A for Pkg Type   | -40 to 125   | SN74HC05N                     | Samples |
| SN74HC05NE4      | ACTIVE        | PDIP         | N               | 14   | 25          | RoHS & Green     | NIPDAU                               | N / A for Pkg Type   | -40 to 125   | SN74HC05N                     | Samples |
| SN74HC05NSR      | ACTIVE        | SO           | NS              | 14   | 2000        | RoHS & Green     | NIPDAU                               | Level-1-260C-UNLIM   | -40 to 125   | HC05                          | Samples |
| SN74HC05NSRE4    | ACTIVE        | SO           | NS              | 14   | 2000        | RoHS & Green     | NIPDAU                               | Level-1-260C-UNLIM   | -40 to 125   | HC05                          | Samples |
| SN74HC05PWR      | ACTIVE        | TSSOP        | PW              | 14   | 2000        | RoHS & Green     | NIPDAU   SN                          | Level-1-260C-UNLIM   | -40 to 125   | HC05                          | Samples |
| SN74HC05PWRG4    | ACTIVE        | TSSOP        | PW              | 14   | 2000        | RoHS & Green     | NIPDAU                               | Level-1-260C-UNLIM   | -40 to 125   | HC05                          | Samples |
| SNJ54HC05FK      | ACTIVE        | LCCC         | FK              | 20   | 55          | Non-RoHS & Green | SNPB                                 | N / A for Pkg Type   | -55 to 125   | 5962-88718012A<br>SNJ54HC05FK | Samples |
| SNJ54HC05J       | ACTIVE        | CDIP         | J               | 14   | 25          | Non-RoHS & Green | SNPB                                 | N / A for Pkg Type   | -55 to 125   | 5962-8871801CA<br>SNJ54HC05J  | Samples |

(1) The marketing status values are defined as follows:

**ACTIVE:** Product device recommended for new designs.

**LIFEBUY:** TI has announced that the device will be discontinued, and a lifetime-buy period is in effect.

**NRND:** Not recommended for new designs. Device is in production to support existing customers, but TI does not recommend using this part in a new design.

**PREVIEW:** Device has been announced but is not in production. Samples may or may not be available.

**OBsolete:** TI has discontinued the production of the device.

(2) **RoHS:** TI defines "RoHS" to mean semiconductor products that are compliant with the current EU RoHS requirements for all 10 RoHS substances, including the requirement that RoHS substance do not exceed 0.1% by weight in homogeneous materials. Where designed to be soldered at high temperatures, "RoHS" products are suitable for use in specified lead-free processes. TI may reference these types of products as "Pb-Free".

**RoHS Exempt:** TI defines "RoHS Exempt" to mean products that contain lead but are compliant with EU RoHS pursuant to a specific EU RoHS exemption.

**Green:** TI defines "Green" to mean the content of Chlorine (Cl) and Bromine (Br) based flame retardants meet JS709B low halogen requirements of  $\leq 1000$ ppm threshold. Antimony trioxide based flame retardants must also meet the  $\leq 1000$ ppm threshold requirement.

(3) MSL, Peak Temp. - The Moisture Sensitivity Level rating according to the JEDEC industry standard classifications, and peak solder temperature.

(4) There may be additional marking, which relates to the logo, the lot trace code information, or the environmental category on the device.

(5) Multiple Device Markings will be inside parentheses. Only one Device Marking contained in parentheses and separated by a "~" will appear on a device. If a line is indented then it is a continuation of the previous line and the two combined represent the entire Device Marking for that device.

(6) Lead finish/Ball material - Orderable Devices may have multiple material finish options. Finish options are separated by a vertical ruled line. Lead finish/Ball material values may wrap to two lines if the finish value exceeds the maximum column width.

**Important Information and Disclaimer:**The information provided on this page represents TI's knowledge and belief as of the date that it is provided. TI bases its knowledge and belief on information provided by third parties, and makes no representation or warranty as to the accuracy of such information. Efforts are underway to better integrate information from third parties. TI has taken and continues to take reasonable steps to provide representative and accurate information but may not have conducted destructive testing or chemical analysis on incoming materials and chemicals. TI and TI suppliers consider certain information to be proprietary, and thus CAS numbers and other limited information may not be available for release.

In no event shall TI's liability arising out of such information exceed the total purchase price of the TI part(s) at issue in this document sold by TI to Customer on an annual basis.

#### OTHER QUALIFIED VERSIONS OF SN54HC05, SN74HC05 :

● Catalog : [SN74HC05](#)

● Military : [SN54HC05](#)

NOTE: Qualified Version Definitions:

● Catalog - TI's standard catalog product

● Military - QML certified for Military and Defense Applications



**TAPE AND REEL INFORMATION**

**QUADRANT ASSIGNMENTS FOR PIN 1 ORIENTATION IN TAPE**

\*All dimensions are nominal

| Device        | Package Type | Package Drawing | Pins | SPQ  | Reel Diameter (mm) | Reel Width W1 (mm) | A0 (mm) | B0 (mm) | K0 (mm) | P1 (mm) | W (mm) | Pin1 Quadrant |
|---------------|--------------|-----------------|------|------|--------------------|--------------------|---------|---------|---------|---------|--------|---------------|
| SN74HC05DR    | SOIC         | D               | 14   | 2500 | 330.0              | 16.4               | 6.5     | 9.0     | 2.1     | 8.0     | 16.0   | Q1            |
| SN74HC05DRG4  | SOIC         | D               | 14   | 2500 | 330.0              | 16.4               | 6.5     | 9.0     | 2.1     | 8.0     | 16.0   | Q1            |
| SN74HC05NSR   | SO           | NS              | 14   | 2000 | 330.0              | 16.4               | 8.45    | 10.55   | 2.5     | 12.0    | 16.2   | Q1            |
| SN74HC05PWR   | TSSOP        | PW              | 14   | 2000 | 330.0              | 12.4               | 6.85    | 5.45    | 1.6     | 8.0     | 12.0   | Q1            |
| SN74HC05PWR   | TSSOP        | PW              | 14   | 2000 | 330.0              | 12.4               | 6.9     | 5.6     | 1.6     | 8.0     | 12.0   | Q1            |
| SN74HC05PWRG4 | TSSOP        | PW              | 14   | 2000 | 330.0              | 12.4               | 6.9     | 5.6     | 1.6     | 8.0     | 12.0   | Q1            |

**TAPE AND REEL BOX DIMENSIONS**

\*All dimensions are nominal

| Device        | Package Type | Package Drawing | Pins | SPQ  | Length (mm) | Width (mm) | Height (mm) |
|---------------|--------------|-----------------|------|------|-------------|------------|-------------|
| SN74HC05DR    | SOIC         | D               | 14   | 2500 | 367.0       | 367.0      | 38.0        |
| SN74HC05DRG4  | SOIC         | D               | 14   | 2500 | 367.0       | 367.0      | 38.0        |
| SN74HC05NSR   | SO           | NS              | 14   | 2000 | 356.0       | 356.0      | 35.0        |
| SN74HC05PWR   | TSSOP        | PW              | 14   | 2000 | 366.0       | 364.0      | 50.0        |
| SN74HC05PWR   | TSSOP        | PW              | 14   | 2000 | 356.0       | 356.0      | 35.0        |
| SN74HC05PWRG4 | TSSOP        | PW              | 14   | 2000 | 356.0       | 356.0      | 35.0        |

**TUBE**

\*All dimensions are nominal

| Device         | Package Name | Package Type | Pins | SPQ | L (mm) | W (mm) | T (μm) | B (mm) |
|----------------|--------------|--------------|------|-----|--------|--------|--------|--------|
| 5962-88718012A | FK           | LCCC         | 20   | 55  | 506.98 | 12.06  | 2030   | NA     |
| SN74HC05N      | N            | PDIP         | 14   | 25  | 506    | 13.97  | 11230  | 4.32   |
| SN74HC05N      | N            | PDIP         | 14   | 25  | 506    | 13.97  | 11230  | 4.32   |
| SN74HC05NE4    | N            | PDIP         | 14   | 25  | 506    | 13.97  | 11230  | 4.32   |
| SN74HC05NE4    | N            | PDIP         | 14   | 25  | 506    | 13.97  | 11230  | 4.32   |
| SNJ54HC05FK    | FK           | LCCC         | 20   | 55  | 506.98 | 12.06  | 2030   | NA     |

# MECHANICAL DATA

NS (R-PDSO-G\*\*)

PLASTIC SMALL-OUTLINE PACKAGE

14-PINS SHOWN



- NOTES:
- A. All linear dimensions are in millimeters.
  - B. This drawing is subject to change without notice.
  - C. Body dimensions do not include mold flash or protrusion, not to exceed 0,15.

## GENERIC PACKAGE VIEW

**FK 20**

**LCCC - 2.03 mm max height**

8.89 x 8.89, 1.27 mm pitch

LEADLESS CERAMIC CHIP CARRIER

This image is a representation of the package family, actual package may vary.  
Refer to the product data sheet for package details.



4229370VA\

J 14

**GENERIC PACKAGE VIEW**  
**CDIP - 5.08 mm max height**  
CERAMIC DUAL IN LINE PACKAGE



Images above are just a representation of the package family, actual package may vary.  
Refer to the product data sheet for package details.

4040083-5/G

J0014A



# PACKAGE OUTLINE

CDIP - 5.08 mm max height

CERAMIC DUAL IN LINE PACKAGE



4214771/A 05/2017

NOTES:

1. All controlling linear dimensions are in inches. Dimensions in brackets are in millimeters. Any dimension in brackets or parenthesis are for reference only. Dimensioning and tolerancing per ASME Y14.5M.
2. This drawing is subject to change without notice.
3. This package is hermetically sealed with a ceramic lid using glass frit.
4. Index point is provided on cap for terminal identification only and on press ceramic glass frit seal only.
5. Falls within MIL-STD-1835 and GDIP1-T14.

# EXAMPLE BOARD LAYOUT

J0014A

CDIP - 5.08 mm max height

CERAMIC DUAL IN LINE PACKAGE



LAND PATTERN EXAMPLE  
NON-SOLDER MASK DEFINED  
SCALE: 5X



4214771/A 05/2017



D (R-PDSO-G14)

PLASTIC SMALL OUTLINE



4040047-5/M 06/11

- NOTES:
- A. All linear dimensions are in inches (millimeters).
  - B. This drawing is subject to change without notice.
  -  Body length does not include mold flash, protrusions, or gate burrs. Mold flash, protrusions, or gate burrs shall not exceed 0.006 (0,15) each side.
  -  Body width does not include interlead flash. Interlead flash shall not exceed 0.017 (0,43) each side.
  - E. Reference JEDEC MS-012 variation AB.

D (R-PDSO-G14)

PLASTIC SMALL OUTLINE



- NOTES:
- All linear dimensions are in millimeters.
  - This drawing is subject to change without notice.
  - Publication IPC-7351 is recommended for alternate designs.
  - Laser cutting apertures with trapezoidal walls and also rounding corners will offer better paste release. Customers should contact their board assembly site for stencil design recommendations. Refer to IPC-7525 for other stencil recommendations.
  - Customers should contact their board fabrication site for solder mask tolerances between and around signal pads.



PW (R-PDSO-G14)

PLASTIC SMALL OUTLINE



4211284-2/G 08/15

- NOTES:
- All linear dimensions are in millimeters.
  - This drawing is subject to change without notice.
  - Publication IPC-7351 is recommended for alternate designs.
  - Laser cutting apertures with trapezoidal walls and also rounding corners will offer better paste release. Customers should contact their board assembly site for stencil design recommendations. Refer to IPC-7525 for other stencil recommendations.
  - Customers should contact their board fabrication site for solder mask tolerances between and around signal pads.

N (R-PDIP-T\*\*)

PLASTIC DUAL-IN-LINE PACKAGE

16 PINS SHOWN



4040049/E 12/2002

- NOTES:
- A. All linear dimensions are in inches (millimeters).
  - B. This drawing is subject to change without notice.
  - Falls within JEDEC MS-001, except 18 and 20 pin minimum body length (Dim A).
  - The 20 pin end lead shoulder width is a vendor option, either half or full width.

## IMPORTANT NOTICE AND DISCLAIMER

TI PROVIDES TECHNICAL AND RELIABILITY DATA (INCLUDING DATA SHEETS), DESIGN RESOURCES (INCLUDING REFERENCE DESIGNS), APPLICATION OR OTHER DESIGN ADVICE, WEB TOOLS, SAFETY INFORMATION, AND OTHER RESOURCES "AS IS" AND WITH ALL FAULTS, AND DISCLAIMS ALL WARRANTIES, EXPRESS AND IMPLIED, INCLUDING WITHOUT LIMITATION ANY IMPLIED WARRANTIES OF MERCHANTABILITY, FITNESS FOR A PARTICULAR PURPOSE OR NON-INFRINGEMENT OF THIRD PARTY INTELLECTUAL PROPERTY RIGHTS.

These resources are intended for skilled developers designing with TI products. You are solely responsible for (1) selecting the appropriate TI products for your application, (2) designing, validating and testing your application, and (3) ensuring your application meets applicable standards, and any other safety, security, regulatory or other requirements.

These resources are subject to change without notice. TI grants you permission to use these resources only for development of an application that uses the TI products described in the resource. Other reproduction and display of these resources is prohibited. No license is granted to any other TI intellectual property right or to any third party intellectual property right. TI disclaims responsibility for, and you will fully indemnify TI and its representatives against, any claims, damages, costs, losses, and liabilities arising out of your use of these resources.

TI's products are provided subject to [TI's Terms of Sale](#) or other applicable terms available either on [ti.com](https://www.ti.com) or provided in conjunction with such TI products. TI's provision of these resources does not expand or otherwise alter TI's applicable warranties or warranty disclaimers for TI products.

TI objects to and rejects any additional or different terms you may have proposed.

Mailing Address: Texas Instruments, Post Office Box 655303, Dallas, Texas 75265  
Copyright © 2023, Texas Instruments Incorporated