

128Kx8 MONOLITHIC NOR FLASH

SMD 5962-96690**

WMF128K8-XXX5



FEATURES

- Access Times of 50*, 60, 70, 90, 120, 150ns
- Packaging
 - 32 lead, Hermetic Ceramic, 0.400" SOJ (Package 101)
 - 32 pin, Hermetic Ceramic, 0.600" DIP (Package 300)
 - 32 lead, Flatpack (Package 220)
 - 32 lead, Formed Flatpack (Package 221)
 - 32 pin, Rectangular Ceramic Leadless Chip Carrier (Package 601)
- 100,000 Erase/Program Cycles Minimum
- Sector Erase Architecture
 - 8 equal size sectors of 16KBytes each
 - Any combination of sectors can be concurrently erased. Also supports full chip erase
- Organized as 128Kx8
- Commercial, Industrial and Military Temperature Ranges
- 5 Volt Programming
- Low Power CMOS
- Embedded Erase and Program Algorithms
- TTL Compatible Inputs and CMOS Outputs
- Page Program Operation and Internal Program Control Time.

This product is subject to change without notice.

Note: For programming information and waveforms refer to Flash Programming 1M5 Application Note AN0036.

* The access time of 50ns is available in Industrial and Commercial temperature ranges only.
 ** For reference only. See table page 8.

PIN CONFIGURATION FOR WMF128K8-XXX5

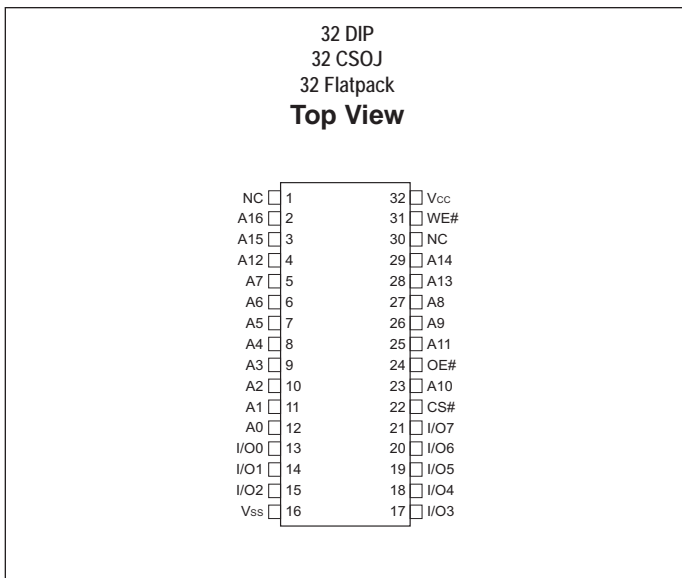

PIN CONFIGURATION FOR WMF128K8-XCLX5

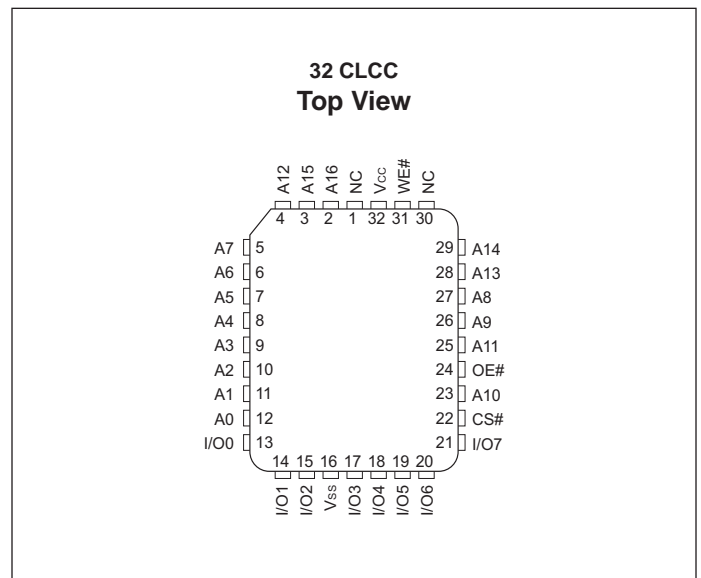

PIN DESCRIPTION

A0-16	Address Inputs
I/O0-7	Data Input/Output
CS#	Chip Select
OE#	Output Enable
WE#	Write Enable
Vcc	+5.0V Power
Vss	Ground

ABSOLUTE MAXIMUM RATINGS (1)

Parameter		Unit
Operating Temperature (Mil, Q)	-55 to +125	°C
Supply Voltage (V _{CC})	-2.0 to +7.0	V
Signal Voltage Range (any pin except A9) (2)	-2.0 to +7.0	V
Storage Temperature Range	-65 to +150	°C
Lead Temperature (soldering, 10 seconds)	+300	°C
Data Retention Mil Temp	10	years
Endurance (write/erase cycles)	100,000 min	cycles
A9 Voltage for sector protect (V _{ID}) (3)	-2.0 to +12.5	V

RECOMMENDED OPERATING CONDITIONS

Parameter	Symbol	Min	Max	Unit
Supply Voltage	V _{CC}	4.5	5.5	V
Operating Temp. (Mil, Q)	T _A	-55	+125	°C
Operating Temp. (Ind)	T _A	-40	+85	°C
Operating Temp. (Com)	T _A	0	+70	°C

CAPACITANCE

T_A = +25°C

Parameter	Symbol	Conditions	Max	Unit
Address Input capacitance	C _{AD}	V _{I/O} = 0 V, f = 1.0 MHz	15	pF
Output Enable capacitance	C _{OE}	V _{IN} = 0 V, f = 1.0 MHz	15	pF
Write Enable capacitance	C _{WE}	V _{IN} = 0 V, f = 1.0 MHz	15	pF
Chip Select capacitance	C _{CS}	V _{IN} = 0 V, f = 1.0 MHz	15	pF
Data I/O capacitance	C _{I/O}	V _{I/O} = 0 V, f = 1.0 MHz	15	pF

This parameter is guaranteed by design but not tested.

NOTES:

- Stresses above the absolute maximum rating may cause permanent damage to the device. Extended operation at the maximum levels may degrade performance and affect reliability.
- Minimum DC voltage on input or I/O pins is -0.5V. During voltage transitions, inputs may overshoot V_{SS} to -2.0 V for periods of up to 20ns. Maximum DC voltage on output and I/O pins is V_{CC} + 0.5V. During voltage transitions, outputs may overshoot to V_{CC} + 2.0 V for periods of up to 20ns.
- Minimum DC input voltage on A9 pin is -0.5V. During voltage transitions, A9 may overshoot V_{SS} to -2V for periods of up to 20ns. Maximum DC input voltage on A9 is +12.5V which may overshoot to 13.5 V for periods up to 20ns.

DC CHARACTERISTICS — CMOS COMPATIBLE

Parameter	Symbol	Conditions	Min	Max	Unit
Input Leakage Current	I _{LI}	V _{CC} = V _{CC MAX} , V _{IN} = GND to V _{CC}		10	µA
Output Leakage Current	I _{LO}	V _{CC} = V _{CC MAX} , V _{OUT} = GND to V _{CC}		10	µA
V _{CC} Active Current for Read (1)	I _{CC1}	CS# = V _{IL} , OE# = V _{IH} , V _{CC} = V _{CC MAX} , f = 5MHz		35	mA
V _{CC} Active Current for Program or Erase (2)	I _{CC2}	CS# = V _{IL} , OE# = V _{IH} , V _{CC} = V _{CC MAX}		50	mA
V _{CC} Standby Current	I _{CC3}	V _{CC} = V _{CC MAX} , CS# = V _{CC} ± 0.5V, OE# = V _{IH} , f = 5MHz		1.6	mA
Input High Voltage	V _{IH}		2.0	V _{CC} + 0.3	V
Input Low Voltage	V _{IL}		-0.5	+0.8	V
Voltage for Auto Select and Sector Protect	V _{ID}		11.5	12.5	V
Output Low Voltage	V _{OL}	I _{OL} = 8.0 mA, V _{CC} = V _{CC MIN}		0.45	V
Output High Voltage	V _{OH1}	I _{OH} = -2.5 mA, V _{CC} = V _{CC MIN}	0.85 x V _{CC}		V
Output High Voltage	V _{OH2}	I _{OH} = -100 µA, V _{CC} = V _{CC MIN}	V _{CC} - 0.4		V
Low V _{CC} Lock-Out Voltage	V _{LKO}		3.2		V

NOTES:

- The I_{CC} current is typically less than 2mA/MHz, with OE# at V_{IH}.
- I_{CC} active while Embedded Algorithm (program or erase) is in progress.

AC TEST CIRCUIT

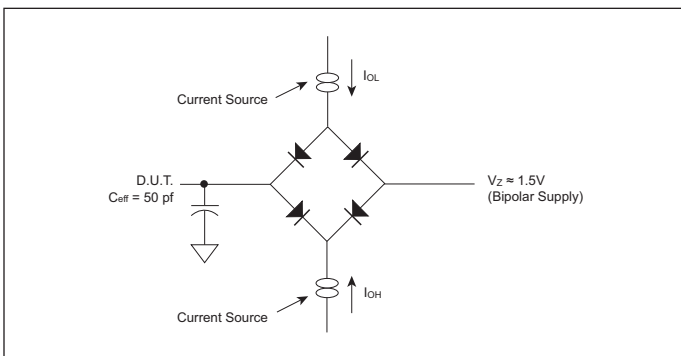

AC TEST CONDITIONS

Parameter	Typ	Unit
Input Pulse Levels	V _{IL} = 0, V _{IH} = 3.0	V
Input Rise and Fall	5	ns
Input and Output Reference Level	1.5	V
Output Timing Reference Level	1.5	V

NOTES:

- V_Z is programmable from -2V to +7V.
- I_{OL} & I_{OH} programmable from 0 to 16mA.
- Tester Impedance Z₀ = 75 Ω.
- V_Z is typically the midpoint of V_{OH} and V_{OL}.
- I_{OL} & I_{OH} are adjusted to simulate a typical resistive load circuit.
- ATE tester includes jig capacitance.

AC CHARACTERISTICS – WRITE/ERASE/PROGRAM OPERATIONS, WE# CONTROLLED

Parameter	Symbol		-50		-60		-70		-90		-120		-150		Unit
			Min	Max	Min	Max	Min	Max	Min	Max	Min	Max	Min	Max	
Write Cycle Time	t _{AVAV}	t _{WC}	50		60		70		90		120		150		ns
Chip Select Setup Time	t _{ELWL}	t _{CS}	0		0		0		0		0		0		ns
Write Enable Pulse Width	t _{WLWH}	t _{WP}	25		30		35		45		50		50		ns
Address Setup Time	t _{AVWH}	t _{AS}	0		0		0		0		0		0		ns
Data Setup Time	t _{DVWH}	t _{DS}	25		30		30		45		50		50		ns
Data Hold Time	t _{WHDX}	t _{DH}	0		0		0		0		0		0		ns
Address Hold Time	t _{WHAX}	t _{AH}	40		45		45		45		50		50		ns
Chip Select Hold Time	t _{WHEH}	t _{CH}	0		0		0		0		0		0		ns
Write Enable Pulse Width High	t _{WHWL}	t _{WPH}	20		20		20		20		20		20		ns
Duration of Byte Programming Operation (min)	t _{WHWH1}		14		14		14		14		14		14		μs
Sector Erase Time	t _{WHWH2}		2.2	60	2.2	60	2.2	60	2.2	60	2.2	60	2.2	60	sec
Read Recovery Time before Write	t _{GHWL}		0		0		0		0		0		0		ns
V _{CC} Set-up Time		t _{VCS}	50		50		50		50		50		50		μs
Chip Programming Time				12.5		12.5		12.5		12.5		12.5		12.5	sec
Output Enable Setup Time		t _{OES}	0		0		0		0		0		0		ns
Output Enable Hold Time (1)		t _{OEH}	10		10		10		10		10		10		ns

NOTES:

- For Toggle and Data# Polling.

AC CHARACTERISTICS – READ ONLY OPERATIONS

Parameter	Symbol		-50		-60		-70		-90		-120		-150		Unit
			Min	Max	Min	Max	Min	Max	Min	Max	Min	Max	Min	Max	
Read Cycle Time	t _{AVAV}	t _{RC}	50		60		70		90		120		150		ns
Address Access Time	t _{AVQV}	t _{ACC}		50		60		70		90		120		150	ns
Chip Select Access Time	t _{ELQV}	t _{CE}		50		60		70		90		120		150	ns
OE# to Output Valid	t _{GLQV}	t _{OE}		25		30		35		40		50		55	ns
Chip Select to Output High Z (1)	t _{EHQZ}	t _{DF}		20		20		20		25		30		35	ns
OE# High to Output High Z (1)	t _{GHQZ}	t _{DF}		20		20		20		25		30		35	ns
Output Hold from Address, CS# or OE# Change, whichever is First	t _{AXQX}	t _{OH}	0		0		0		0		0		0		ns

NOTES:

- Guaranteed by design, but not tested

AC CHARACTERISTICS – WRITE/ERASE/PROGRAM OPERATIONS, CS# CONTROLLED

Parameter	Symbol		-50		-60		-70		-90		-120		-150		Unit
			Min	Max	Min	Max	Min	Max	Min	Max	Min	Max	Min	Max	
Write Cycle Time	t _{AVAV}	t _{WC}	50		60		70		90		120		150		ns
WE# Setup Time	t _{WLLEL}	t _{WS}	0		0		0		0		0		0		ns
CS# Pulse Width	t _{ELEH}	t _{CP}	25		30		35		45		50		50		ns
Address Setup Time	t _{AVEL}	t _{AS}	0		0		0		0		0		0		ns
Data Setup Time	t _{DVEH}	t _{DS}	25		30		30		45		50		50		ns
Data Hold Time	t _{EHDX}	t _{DH}	0		0		0		0		0		0		ns
Address Hold Time	t _{ELAX}	t _{AH}	40		45		45		45		50		50		ns
WE# Hold from WE# High	t _{EHWH}	t _{WH}	0		0		0		0		0		0		ns
CS# Pulse Width High	t _{EHLEL}	t _{CPH}	20		20		20		20		20		20		ns
Duration of Programming Operation	t _{WHWH1}		14		14		14		14		14		14		μs
Duration of Erase Operation	t _{WHWH2}		2.2	60	2.2	60	2.2	60	2.2	60	2.2	60	2.2	60	sec
Read Recovery before Write	t _{GHLEL}		0		0		0		0		0		0		ns
Chip Programming Time				12.5		12.5		12.5		12.5		12.5		12.5	sec

PACKAGE 101 – 32 LEAD, CERAMIC SOJ

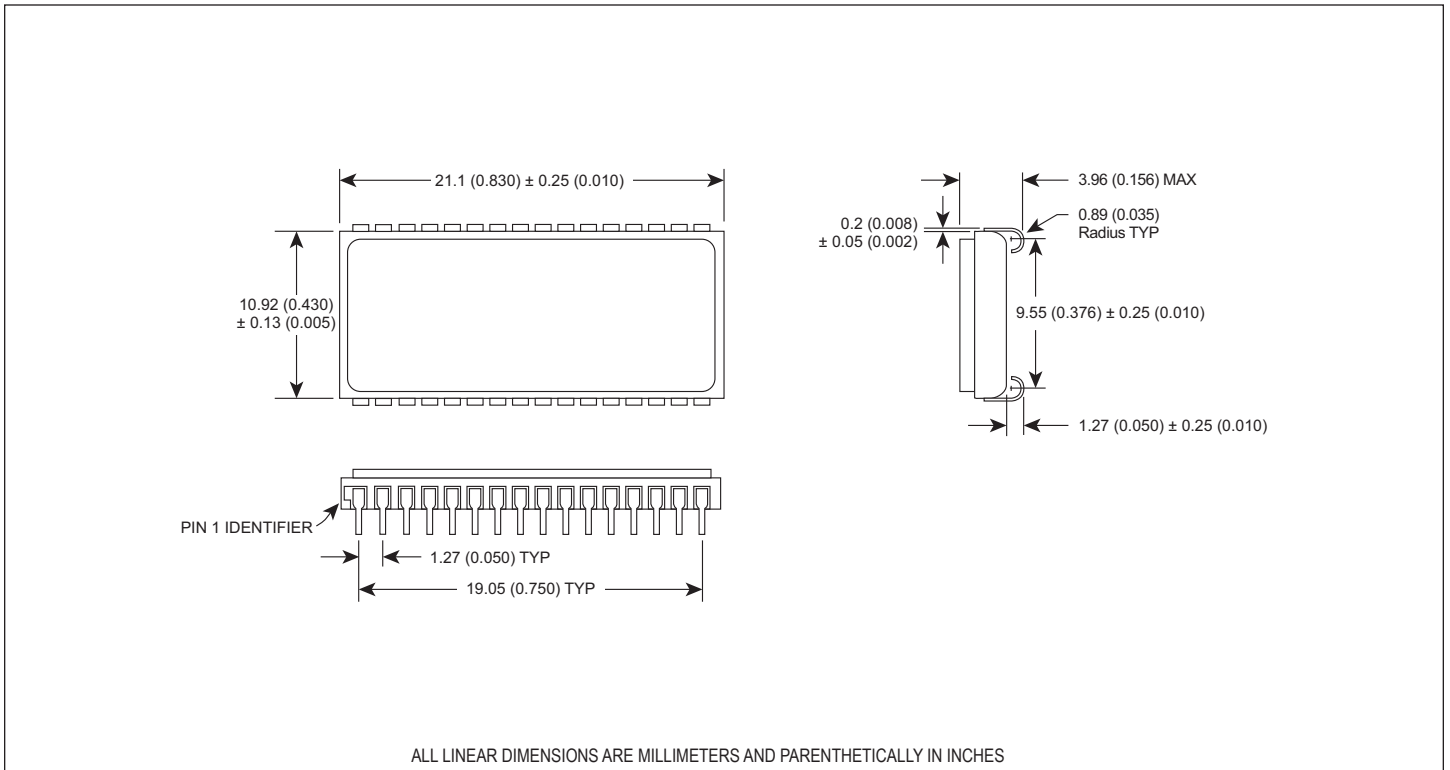

PACKAGE 220 – 32 LEAD, CERAMIC FLATPACK

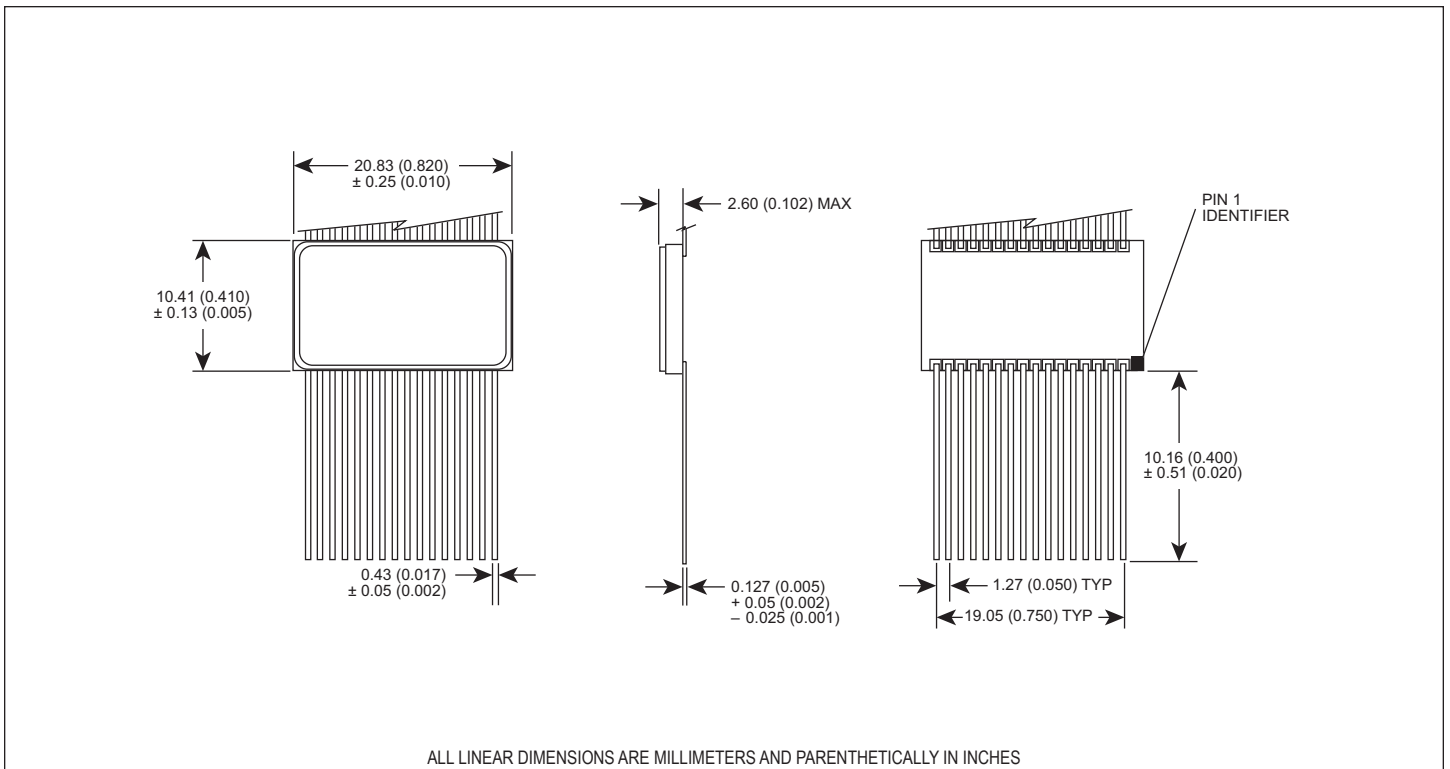

PACKAGE 221 – 32 LEAD, FORMED CERAMIC FLATPACK

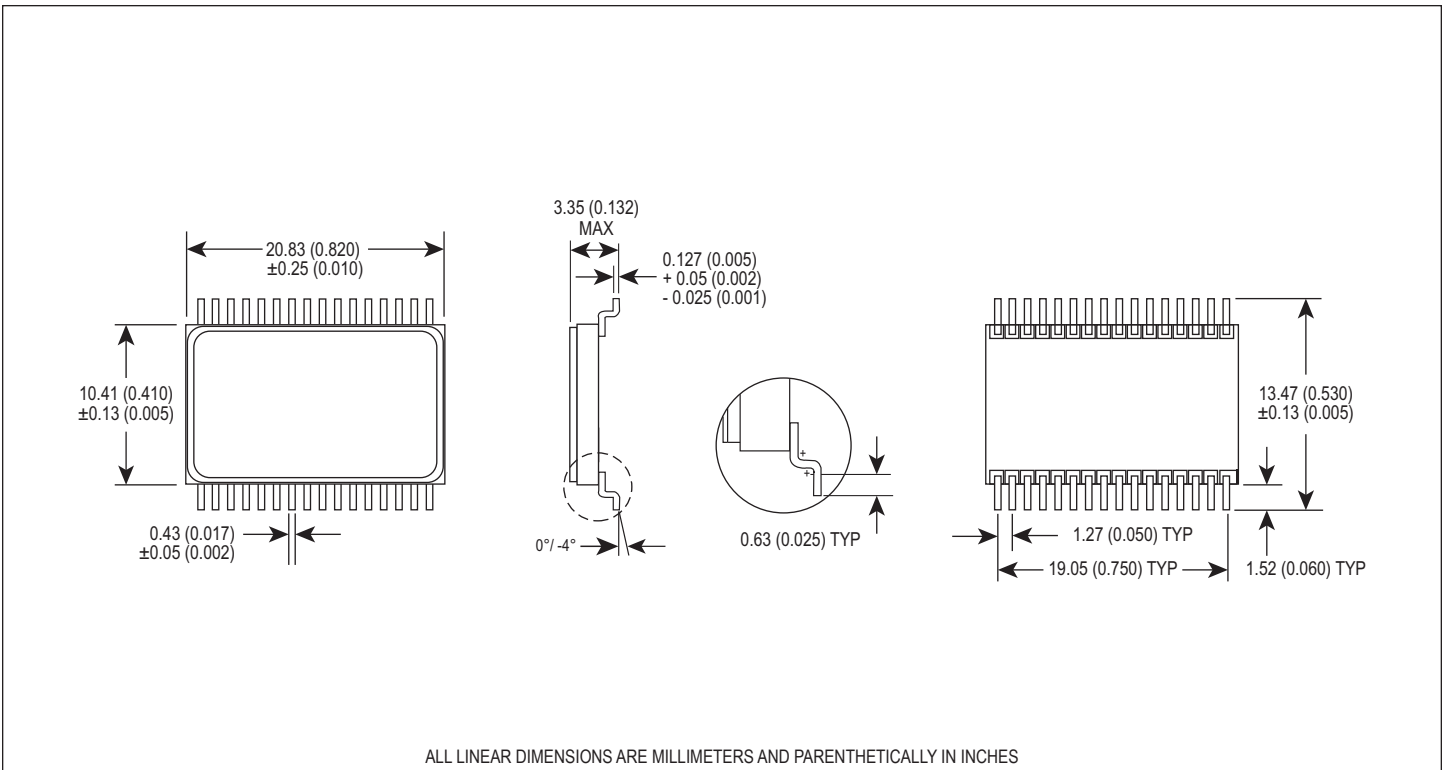

PACKAGE 300 – 32 PIN, CERAMIC DIP, SINGLE CAVITY SIDE BRAZED

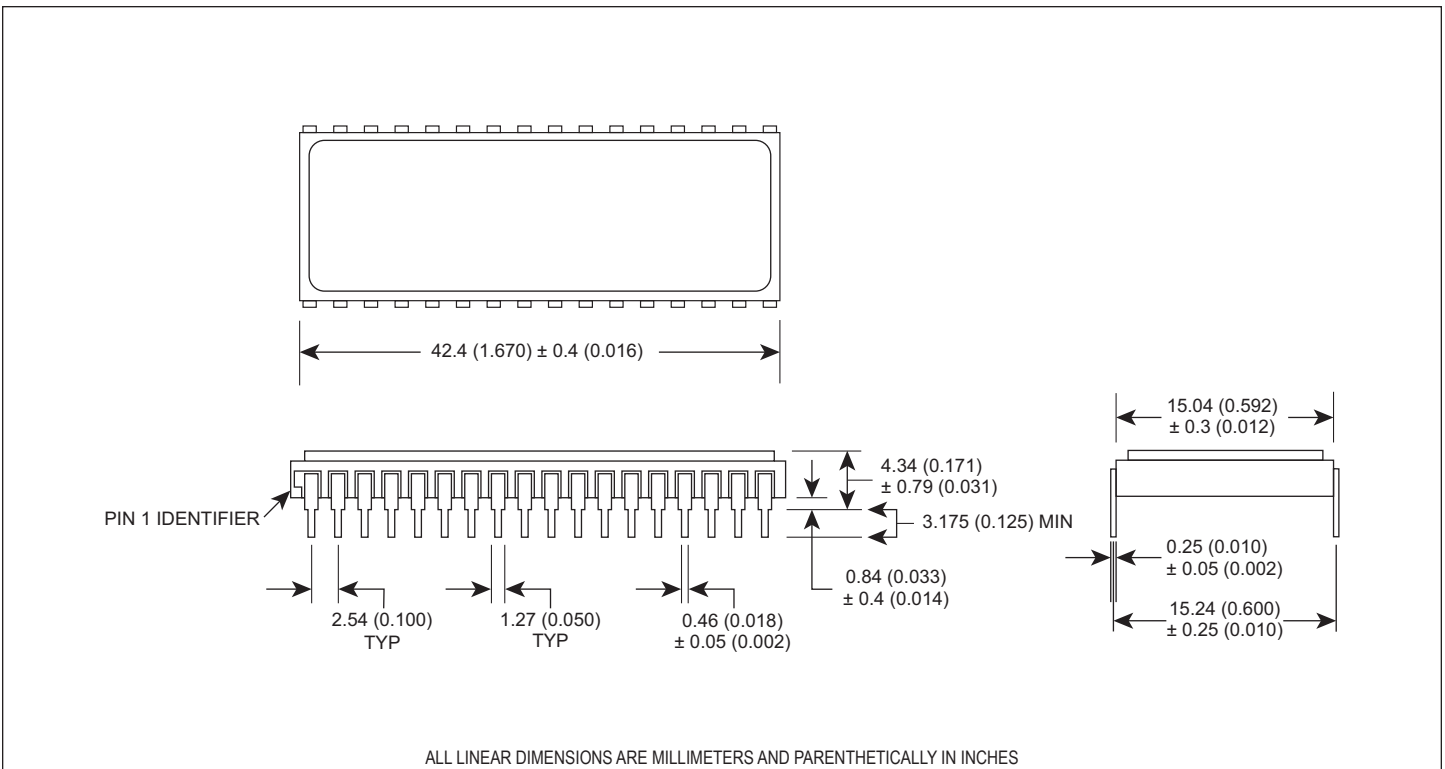

PACKAGE 601 – 32 PIN, RECTANGULAR CERAMIC LEADLESS CHIP CARRIER

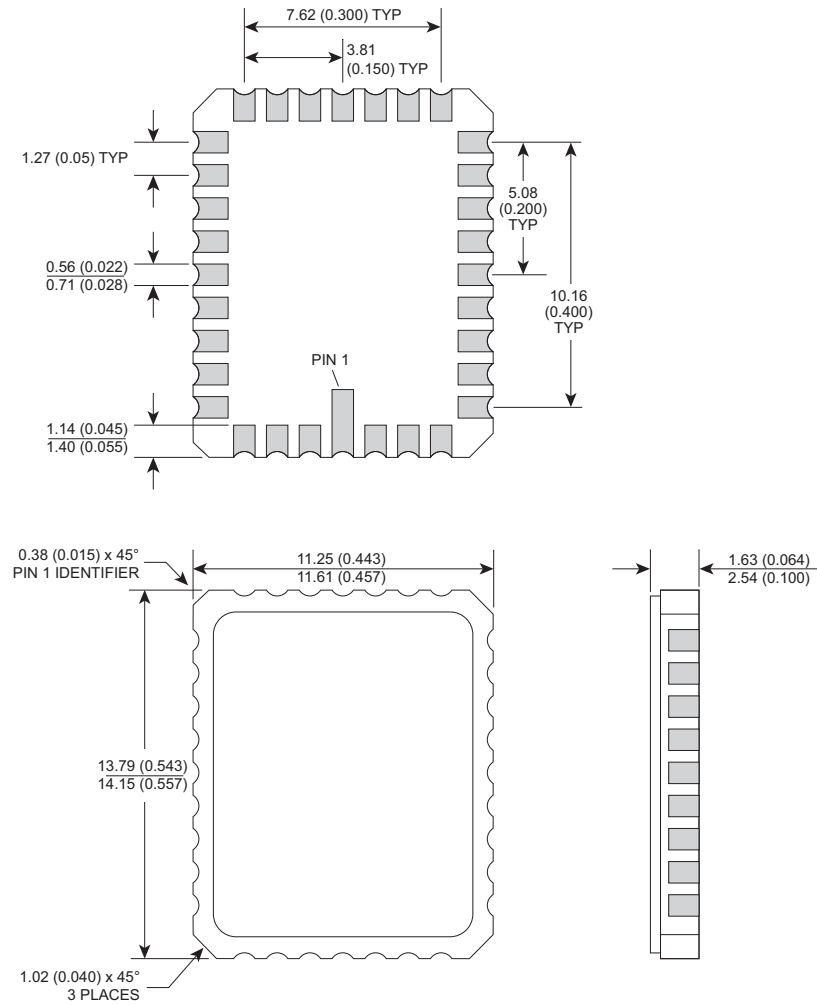

ALL LINEAR DIMENSIONS ARE MILLIMETERS AND PARENTHETICALLY IN INCHES

ORDERING INFORMATION

W M F 128K8 - XXX X X 5 X

MERCURY SYSTEMS _____

MONOLITHIC _____

NOR FLASH _____

ORGANIZATION, 128K x 8 _____

ACCESS TIME (ns) _____

PACKAGE TYPE: _____

- DE = 32 Lead Ceramic SOJ (Package 101)
- C = 32 Pin Ceramic DIP (Package 300)
- FE = 32 Lead Ceramic Flatpack (Package 220)
- FF = 32 Lead Formed Ceramic Flatpack (Package 221)
- CL = 32 Pin rectangular Ceramic Leadless Chip Carrier (Package 601)

DEVICE GRADE: _____

- Q = Military Grade*
- M = Military Screened -55°C to +125°C
- I = Industrial -40°C to +85°C
- C = Commercial 0°C to +70°C

V_{PP} PROGRAMMING VOLTAGE _____

- 5 = 5V

LEAD FINISH: _____

- Blank = Gold plated leads
- A = Solder dip leads

* This product is processed the same as the 5962-XXXXXHX product but all test and mechanical requirements are per the Mercury Systems data sheet.

DEVICE TYPE	SECTOR SIZE	SPEED	PACKAGE	SMD NO.
128K x 8 Flash Monolithic	16KByte	150ns	32 pin DIP (C)	5962-96690 01HYX
128K x 8 Flash Monolithic	16KByte	120ns	32 pin DIP (C)	5962-96690 02HYX
128K x 8 Flash Monolithic	16KByte	90ns	32 pin DIP (C)	5962-96690 03HYX
128K x 8 Flash Monolithic	16KByte	70ns	32 pin DIP (C)	5962-96690 04HYX
128K x 8 Flash Monolithic	16KByte	60ns	32 pin DIP (C)	5962-96690 05HYX
128K x 8 Flash Monolithic	16KByte	150ns	32 lead SOJ (DE)	5962-96690 01HXX
128K x 8 Flash Monolithic	16KByte	120ns	32 lead SOJ (DE)	5962-96690 02HXX
128K x 8 Flash Monolithic	16KByte	90ns	32 lead SOJ (DE)	5962-96690 03HXX
128K x 8 Flash Monolithic	16KByte	70ns	32 lead SOJ (DE)	5962-96690 04HXX
128K x 8 Flash Monolithic	16KByte	60ns	32 lead SOJ (DE)	5962-96690 05HXX
128K x 8 Flash Monolithic	16KByte	150ns	32 lead Flatpack (FE)	5962-96690 01HTX
128K x 8 Flash Monolithic	16KByte	120ns	32 lead Flatpack (FE)	5962-96690 02HTX
128K x 8 Flash Monolithic	16KByte	90ns	32 lead Flatpack (FE)	5962-96690 03HTX
128K x 8 Flash Monolithic	16KByte	70ns	32 lead Flatpack (FE)	5962-96690 04HTX
128K x 8 Flash Monolithic	16KByte	60ns	32 lead Flatpack (FE)	5962-96690 05HTX
128K x 8 Flash Monolithic	16KByte	150ns	32 lead Formed Flatpack (FF)	5962-96690 01HUX
128K x 8 Flash Monolithic	16KByte	120ns	32 lead Formed Flatpack (FF)	5962-96690 02HUX
128K x 8 Flash Monolithic	16KByte	90ns	32 lead Formed Flatpack (FF)	5962-96690 03HUX
128K x 8 Flash Monolithic	16KByte	70ns	32 lead Formed Flatpack (FF)	5962-96690 04HUX
128K x 8 Flash Monolithic	16KByte	60ns	32 lead Formed Flatpack (FF)	5962-96690 05HUX

NOTE: This table is for reference only. For 5962-96690 ordering information and specifications refer to latest SMD document.

Document Title

128Kx8 MONOLITHIC NOR FLASH, SMD 5962-96690

Revision History

Rev #	History	Release Date	Status
Rev 6	Changes (Pg. 1-14) 6.1 Change document layout from White Electronic Designs to Microsemi 6.2 Add document Revision History page	June 2011	Final
Rev 7	Changes (Pg. 1, 14) 7.1 Add "NOR" to headline	August 2011	Final
Rev 8	Changes (Pg. 1-14) 8.1 Update features 8.2 Update <i>Absolute Maximum Ratings, Recommended Operating Conditions and DC Characteristics</i> charts 8.3 Remove subhead line from AC Characteristics charts 8.4 Remove all waveforms diagrams 8.5 Update Package 101 diagram 8.6 Update Package 221 diagram 8.7 Update Package 300 diagram 8.8 Update Package 601 diagram 8.9 Add NOR to Flash option on <i>Ordering Information</i> chart 8.10 Add note to SMD table	June 2012	Final
Rev 9	Change (Pg. 7) 9.1 Changed Device Grade "Q" description from "MIL-STD-883 Compliant" to "MIL-PRF-38534 Class H Compliant."	May 2014	Final
Rev 10	Change (Pg. 7) 10.1 Changed Device Grade "Q" description from "MIL-PRF-38534 Class H Compliant." to "Military Grade."	August 2014	Final
Rev 11	Changes (Pg. All) (ECN 10156) 11.1 Change document layout from Microsemi to Mercury Systems	August 2016	Final