



**THIS SPEC IS OBSOLETE**

**Spec No:** 38-05087

**Spec Title:** CY62136V MOBL(R) 2-MBIT (128K X 16)  
STATIC RAM

**Sunset Owner:** Anuj Chakrapani (AJU)

**Replaced by:** None

## 2-Mbit (128K x 16) Static RAM

### Features

- **High speed**
  - 55 ns
- **Temperature Ranges**
  - Industrial: -40°C to 85°C
  - Automotive: -40°C to 125°C
- **Wide voltage range**
  - 2.7V – 3.6V
- **Ultra-low active, standby power**
- **Easy memory expansion with  $\overline{CE}$  and  $\overline{OE}$  features**
- **TTL-compatible inputs and outputs**
- **Automatic power-down when deselected**
- **CMOS for optimum speed/power**
- **Available in a Pb-free and non Pb-free 44-pin TSOP Type II (forward pinout) and 48-ball FBGA packages**

### Functional Description<sup>[1]</sup>

The CY62136V is a high-performance CMOS static RAM organized as 128K words by 16 bits. This device features advanced circuit design to provide ultra-low active current.

This is ideal for providing More Battery Life™ (MoBL<sup>®</sup>) in portable applications such as cellular telephones. The device also has an automatic power-down feature that significantly reduces power consumption by 99% when addresses are not toggling. The device can also be put into standby mode when deselected ( $\overline{CE}$  HIGH). The input/output pins ( $I/O_0$  through  $I/O_{15}$ ) are placed in a high-impedance state when: deselected ( $\overline{CE}$  HIGH), outputs are disabled ( $\overline{OE}$  HIGH),  $\overline{BHE}$  and  $\overline{BLE}$  are disabled ( $\overline{BHE}$ ,  $\overline{BLE}$  HIGH), or during a write operation ( $\overline{CE}$  LOW, and  $\overline{WE}$  LOW).

Writing to the device is accomplished by taking Chip Enable ( $\overline{CE}$ ) and Write Enable ( $\overline{WE}$ ) inputs LOW. If Byte Low Enable ( $\overline{BLE}$ ) is LOW, then data from  $I/O$  pins ( $I/O_0$  through  $I/O_7$ ), is written into the location specified on the address pins ( $A_0$  through  $A_{16}$ ). If Byte High Enable ( $\overline{BHE}$ ) is LOW, then data from  $I/O$  pins ( $I/O_8$  through  $I/O_{15}$ ) is written into the location specified on the address pins ( $A_0$  through  $A_{16}$ ).

Reading from the device is accomplished by taking Chip Enable ( $\overline{CE}$ ) and Output Enable ( $\overline{OE}$ ) LOW while forcing the Write Enable ( $\overline{WE}$ ) HIGH. If Byte Low Enable ( $\overline{BLE}$ ) is LOW, then data from the memory location specified by the address pins will appear on  $I/O_0$  to  $I/O_7$ . If Byte High Enable ( $\overline{BHE}$ ) is LOW, then data from memory will appear on  $I/O_8$  to  $I/O_{15}$ . See the Truth Table at the back of this data sheet for a complete description of read and write modes.

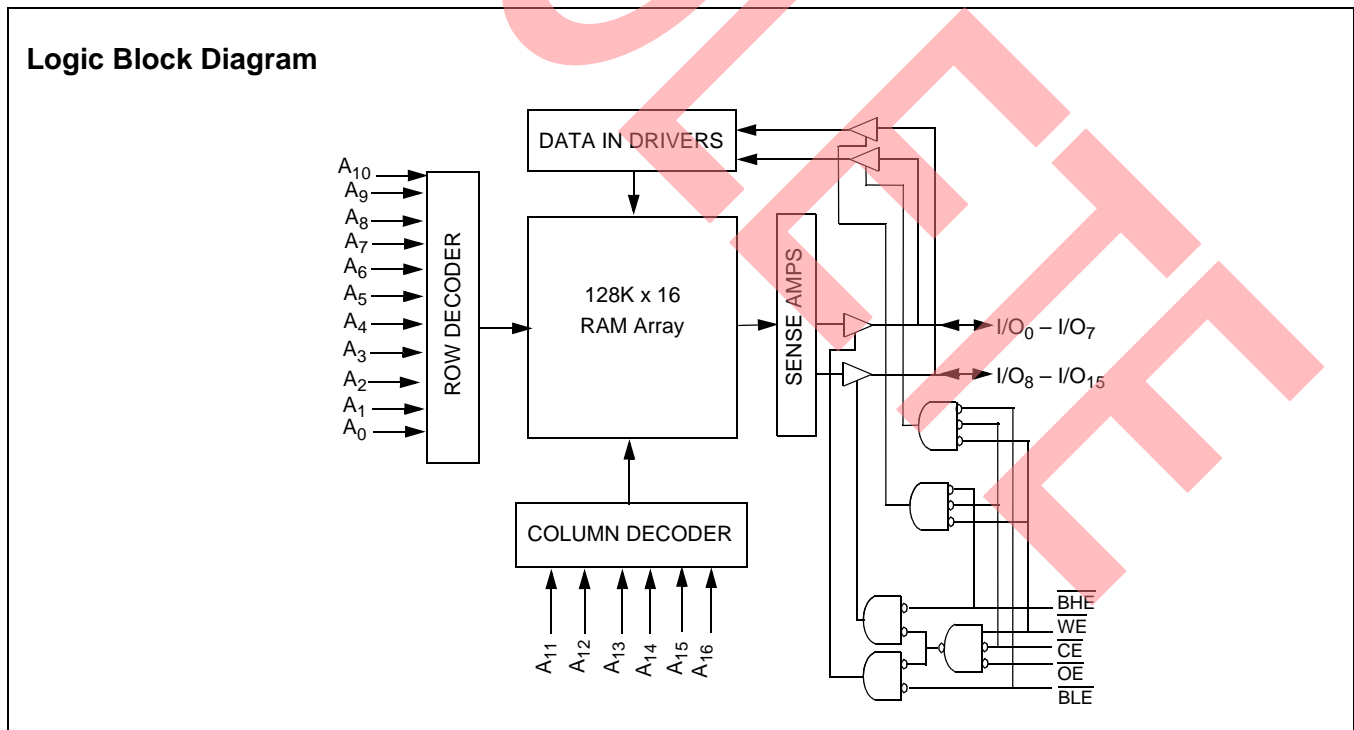

**Note:**

1. For best practice recommendations, please refer to the Cypress application note "System Design Guidelines" on <http://www.cypress.com>.

Product Portfolio

Product	V <sub>CC</sub> Range (V)			Speed	Grades	Power Dissipation (Industrial)			
	Min.	Typ. <sup>[2]</sup>	Max.			Operating, I <sub>CC</sub> (mA)		Standby, I <sub>SB2</sub> (μA)	
						Typ. <sup>[2]</sup>	Maximum	Typ. <sup>[2]</sup>	Maximum
CY62136VLL	2.7	3.0	3.6	55	Industrial	7	20	1	15
					Industrial	7	15	1	15
					Automotive	7	20	1	20

Pin Configurations<sup>[3, 4]</sup>

TSOP II (Forward)  
Top View

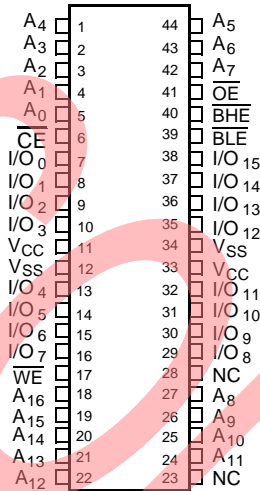

48-ball FBGA  
Top View

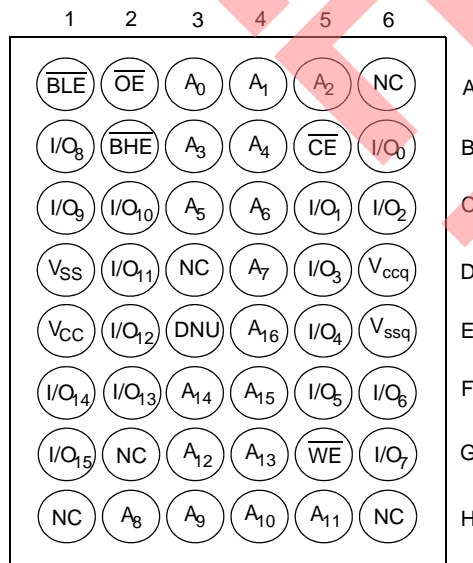

Notes:

- Typical values are included for reference only and are not guaranteed or tested. Typical values are measured at V<sub>CC</sub> = V<sub>CC</sub> Typ, T<sub>A</sub> = 25°C.
- NC pins are not connected on the die.
- E3 (DNU) pin have to be left floating or tied to V<sub>SS</sub> to ensure proper operation.

**Pin Definitions**

Pin Number	Type	Description
1–5, 18–22, 24–27, 42–45	Input	<b>A<sub>0</sub>–A<sub>16</sub></b> . Address Inputs
7–10, 13–16, 29–32, 35–38	Input/Output	<b>I/O<sub>0</sub>–I/O<sub>15</sub></b> . Data lines. Used as input or output lines depending on operation
23	No Connect	<b>NC</b> . This pin is not connected to the die
17	Input/Control	<b><math>\overline{WE}</math></b> . When selected LOW, a WRITE is conducted. When selected HIGH, a READ is conducted
6	Input/Control	<b><math>\overline{CE}</math></b> . When LOW, selects the chip. When HIGH, deselects the chip
40, 39	Input/Control	<b><math>\overline{BHE}</math>, <math>\overline{BLE}</math></b> . $\overline{BHE}$ = LOW selects higher order byte WRITES or READs on the SRAM $\overline{BLE}$ = LOW selects lower order byte WRITES or READs on the SRAM
41	Input/Control	<b><math>\overline{OE}</math></b> . Output Enable. Controls the direction of the I/O pins. When LOW, the I/O pins behave as outputs. When deasserted HIGH, I/O pins are Tri-stated, and act as input data pins
12, 34	Ground	<b>V<sub>SS</sub></b> . Ground for the device
11, 33	Power Supply	<b>V<sub>CC</sub></b> . Power supply for the device

### Maximum Ratings

(Above which the useful life may be impaired. For user guidelines, not tested.)

Storage Temperature .....	-65°C to +150°C
Ambient Temperature with Power Applied.....	-55°C to +125°C
Supply Voltage to Ground Potential .....	-0.5V to +4.6V
DC Voltage Applied to Outputs in High-Z State <sup>[5]</sup> .....	-0.5V to V <sub>CC</sub> + 0.5V
DC Input Voltage <sup>[5]</sup> .....	-0.5V to V <sub>CC</sub> + 0.5V

Output Current into Outputs (LOW).....	20 mA
Static Discharge Voltage.....	> 2001V (per MIL-STD-883, Method 3015)
Latch-up Current.....	> 200 mA

### Operating Range

Range	Ambient Temperature [T <sub>A</sub> ] <sup>[7]</sup>	V <sub>CC</sub>
Industrial	-40°C to +85°C	2.7V to 3.6V
Automotive	-40°C to +125°C	

### Electrical Characteristics Over the Operating Range

Parameter	Description	Test Conditions	CY62136V-55			CY62136V-70			Unit
			Min.	Typ. <sup>[2]</sup>	Max.	Min.	Typ. <sup>[2]</sup>	Max.	
V <sub>OH</sub>	Output HIGH Voltage	I <sub>OH</sub> = -1.0 mA, V <sub>CC</sub> = 2.7V	2.4			2.4			V
V <sub>OL</sub>	Output LOW Voltage	I <sub>OL</sub> = 2.1 mA, V <sub>CC</sub> = 2.7V			0.4			0.4	V
V <sub>IH</sub>	Input HIGH Voltage	V <sub>CC</sub> = 3.6V	2.2		V <sub>CC</sub> + 0.5V	2.2		V <sub>CC</sub> + 0.5V	V
V <sub>IL</sub>	Input LOW Voltage	V <sub>CC</sub> = 2.7V	-0.5		0.8	-0.5		0.8	V
I <sub>IX</sub>	Input Leakage Current	GND ≤ V <sub>I</sub> ≤ V <sub>CC</sub>	Industrial	-1	+1	-1	+1	μA	
			Automotive			-10	+10	μA	
I <sub>OZ</sub>	Output Leakage Current	GND ≤ V <sub>O</sub> ≤ V <sub>CC</sub> , Output Disabled	Industrial	-1	+1	-1	+1	μA	
			Automotive			-10	+10	μA	
I <sub>CC</sub>	V <sub>CC</sub> Operating Supply Current	f = f <sub>Max</sub> = 1/t <sub>RC</sub> , V <sub>CC</sub> = 3.6V, I <sub>OUT</sub> = 0 mA, CMOS Levels	Industrial		7	20	7	15	mA
			Automotive				7	20	mA
					1	2	1	2	mA
I <sub>SB1</sub>	Automatic CE Power-down Current—CMOS Inputs	$\overline{CE} \geq V_{CC} - 0.3V$ , V <sub>IN</sub> ≥ V <sub>CC</sub> - 0.3V or V <sub>IN</sub> ≤ 0.3V, f = f <sub>Max</sub>			100			100	μA
I <sub>SB2</sub>	Automatic CE Power-down Current—CMOS Inputs	$\overline{CE} \geq V_{CC} - 0.3V$ , V <sub>IN</sub> ≥ V <sub>CC</sub> - 0.3V or V <sub>IN</sub> ≤ 0.3V, f = 0, V <sub>CC</sub> = 3.6V	Industrial		1	15	1	15	μA
			Automotive				1	20	μA

### Capacitance<sup>[6]</sup>

Parameter	Description	Test Conditions	Max.	Unit
C <sub>IN</sub>	Input Capacitance	T <sub>A</sub> = 25°C, f = 1 MHz, V <sub>CC</sub> = V <sub>CC</sub> (typ)	6	pF
C <sub>OUT</sub>	Output Capacitance		8	pF

### Thermal Resistance<sup>[6]</sup>

Parameter	Description	Test Conditions	FBGA	TSOPII	Unit
Θ <sub>JA</sub>	Thermal Resistance (Junction to Ambient)	Still Air, soldered on a 4.25 x 1.125 inch, 2-layer printed circuit board	41.17	60	°C/W
Θ <sub>JC</sub>	Thermal Resistance (Junction to Case)		11.74	22	°C/W

#### Notes:

- V<sub>IL</sub>(min) = -2.0V for pulse durations less than 20 ns.
- Tested initially and after any design or process changes that may affect these parameters.
- T<sub>A</sub> is the "Instant-On" case temperature.

AC Test Loads and Waveforms

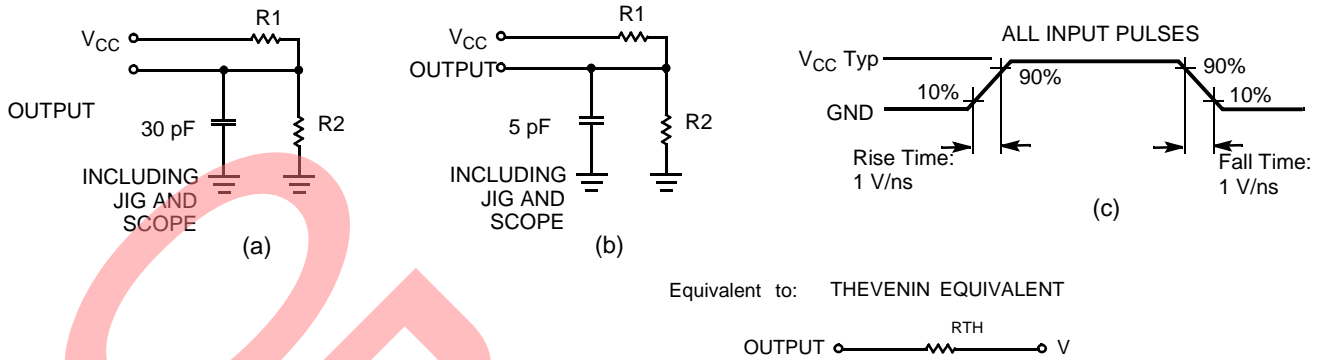

Parameters	3.0V	Unit
R1	1105	Ohms
R2	1550	Ohms
R <sub>TH</sub>	645	Ohms
V <sub>TH</sub>	1.75	Volts

Data Retention Characteristics (Over the Operating Range)

Parameter	Description	Conditions <sup>[9]</sup>	Min.	Typ. <sup>[2]</sup>	Max.	Unit
V <sub>DR</sub>	V <sub>CC</sub> for Data Retention		1.0		3.6	V
I <sub>CCDR</sub>	Data Retention Current	V <sub>CC</sub> = 1.0V, $\overline{CE} \geq V_{CC} - 0.3V$ , V <sub>IN</sub> ≥ V <sub>CC</sub> - 0.3V or V <sub>IN</sub> ≤ 0.3V, No input may exceed V <sub>CC</sub> + 0.3V		0.5	7.5	μA
t <sub>CDR</sub> <sup>[6]</sup>	Chip Deselect to Data Retention Time		0			ns
t <sub>R</sub> <sup>[8]</sup>	Operation Recovery Time		70			ns

Data Retention Waveform

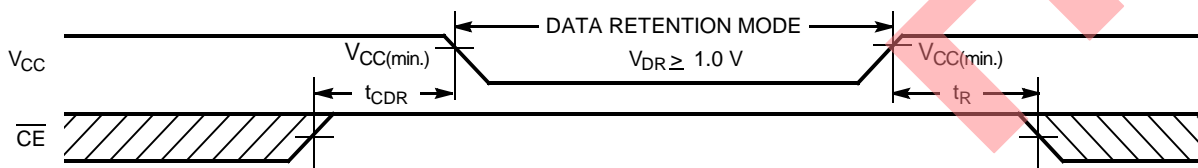

Notes:

- 8. Full device operation requires linear V<sub>CC</sub> ramp from V<sub>DR</sub> to V<sub>CC(min.)</sub> ≥ 100 μs or stable at V<sub>CC(min.)</sub> ≥ 100 μs.
- 9. Test conditions assume signal transition time of 5 ns or less, timing reference levels of 1.5V, input pulse levels of 0 to V<sub>CC(typ.)</sub>, and output loading of the specified I<sub>OL</sub>/I<sub>OH</sub> and 30 pF load capacitance.

**Switching Characteristics** Over the Operating Range <sup>[9]</sup>

Parameter	Description	55 ns		70 ns		Unit
		Min.	Max.	Min.	Max.	
<b>Read Cycle</b>						
t <sub>RC</sub>	Read Cycle Time	55		70		ns
t <sub>AA</sub>	Address to Data Valid		55		70	ns
t <sub>OHA</sub>	Data Hold from Address Change	10		10		ns
t <sub>ACE</sub>	$\overline{CE}$ LOW to Data Valid		55		70	ns
t <sub>DOE</sub>	$\overline{OE}$ LOW to Data Valid		25		35	ns
t <sub>LZOE</sub>	$\overline{OE}$ LOW to Low-Z <sup>[10]</sup>	5		5		ns
t <sub>HZOE</sub>	$\overline{OE}$ HIGH to High-Z <sup>[10, 11]</sup>		25		25	ns
t <sub>LZCE</sub>	$\overline{CE}$ LOW to Low-Z <sup>[10]</sup>	10		10		ns
t <sub>HZCE</sub>	$\overline{CE}$ HIGH to High-Z <sup>[10, 11]</sup>		25		25	ns
t <sub>PU</sub>	$\overline{CE}$ LOW to Power-up	0		0		ns
t <sub>PD</sub>	$\overline{CE}$ HIGH to Power-down		55		70	ns
t <sub>DBE</sub>	$\overline{BLE}/\overline{BHE}$ LOW to Data Valid		25		35	ns
t <sub>LZBE</sub>	$\overline{BLE}/\overline{BHE}$ LOW to Low-Z <sup>[10, 11]</sup>	5		5		ns
t <sub>HZBE</sub>	$\overline{BLE}/\overline{BHE}$ HIGH to High-Z <sup>[12]</sup>		25		25	ns
<b>Write Cycle</b> <sup>[12, 13]</sup>						
t <sub>WC</sub>	Write Cycle Time	55		70		ns
t <sub>SCE</sub>	$\overline{CE}$ LOW to Write End	45		60		ns
t <sub>AW</sub>	Address Set-up to Write End	45		60		ns
t <sub>HA</sub>	Address Hold from Write End	0		0		ns
t <sub>SA</sub>	Address Set-up to Write Start	0		0		ns
t <sub>PWE</sub>	$\overline{WE}$ Pulse Width	40		50		ns
t <sub>BW</sub>	$\overline{BLE}/\overline{BHE}$ LOW to Write End	50		60		ns
t <sub>SD</sub>	Data Set-up to Write End	25		30		ns
t <sub>HD</sub>	Data Hold from Write End	0		0		ns
t <sub>HZWE</sub>	$\overline{WE}$ LOW to High-Z <sup>[10, 11]</sup>		20		25	ns
t <sub>LZWE</sub>	$\overline{WE}$ HIGH to Low-Z <sup>[10]</sup>	5		10		ns

**Notes:**

10. At any given temperature and voltage condition, t<sub>HZCE</sub> is less than t<sub>LZCE</sub>, t<sub>HZOE</sub> is less than t<sub>LZOE</sub>, and t<sub>HZWE</sub> is less than t<sub>LZWE</sub> for any given device.
11. t<sub>HZOE</sub>, t<sub>HZCE</sub>, and t<sub>HZWE</sub> are specified with C<sub>L</sub> = 5 pF as in (b) of AC Test Loads. Transition is measured ±500 mV from steady-state voltage.
12. The internal write time of the memory is defined by the overlap of CE LOW and WE LOW. Both signals must be LOW to initiate a write and either signal can terminate a write by going HIGH. The data input set-up and hold timing should be referenced to the rising edge of the signal that terminates the write.
13. The minimum write cycle time for write cycle 3 (WE controlled, OE LOW) is the sum of t<sub>HZWE</sub> and t<sub>SD</sub>.

### Switching Waveforms

#### Read Cycle No. 1 (Address Transition Controlled)<sup>[14, 15]</sup>

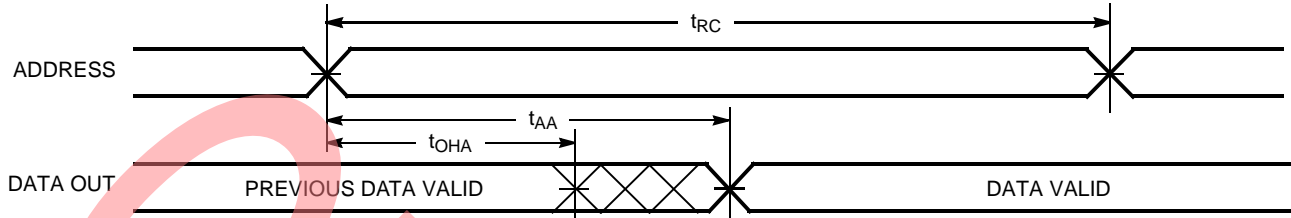

#### Read Cycle No. 2 ( $\overline{OE}$ Controlled)<sup>[15, 16]</sup>

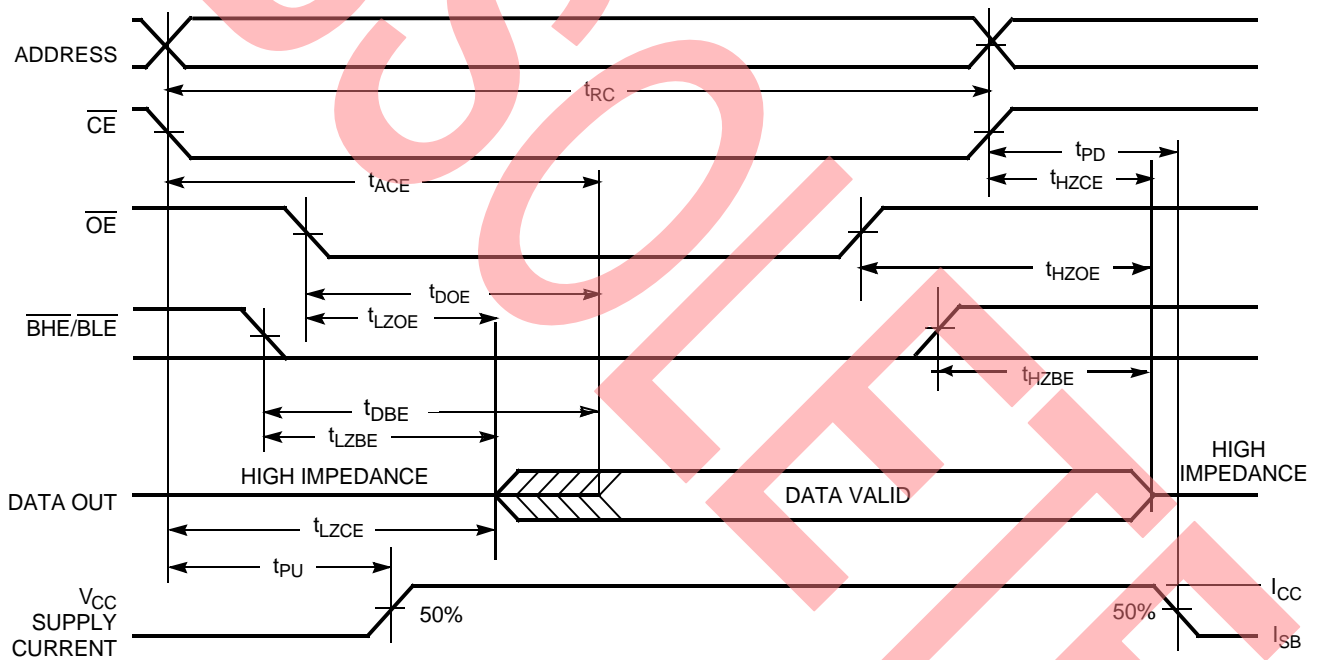

**Notes:**

- 14. Device is continuously selected.  $\overline{OE}$ ,  $\overline{CE} = V_{IL}$ .
- 15. WE is HIGH for read cycle.
- 16. Address valid prior to or coincident with  $\overline{CE}$  transition LOW.



Switching Waveforms (continued)

Write Cycle No. 1 ( $\overline{\text{WE}}$  Controlled)<sup>[12, 17, 18]</sup>

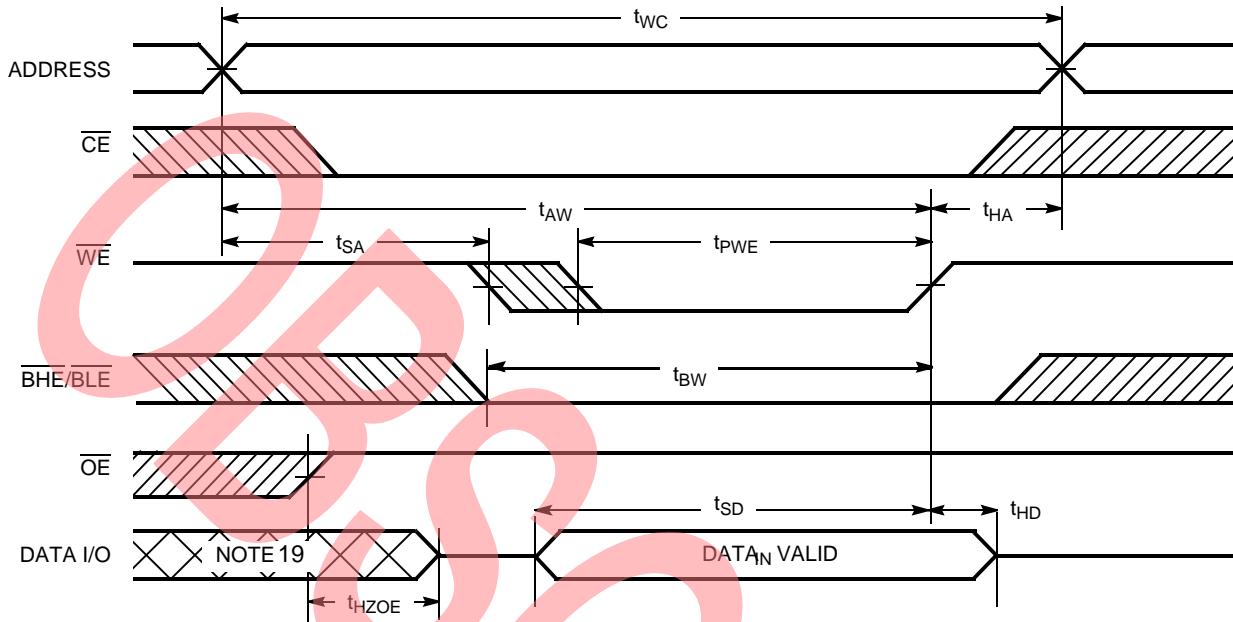

Write Cycle No. 2 ( $\overline{\text{CE}}$  Controlled)<sup>[12, 17, 18]</sup>

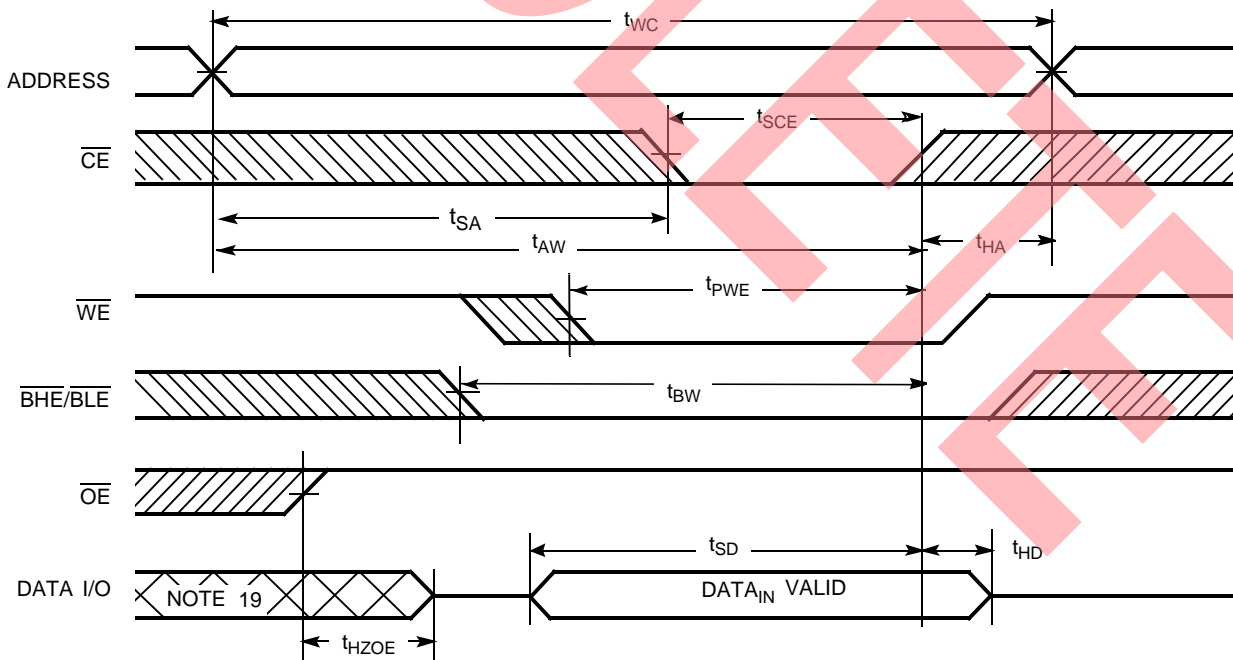

Notes:

- 17. Data I/O is high impedance if  $\overline{\text{OE}} = V_{IH}$ .
- 18. If  $\overline{\text{CE}}$  goes HIGH simultaneously with  $\overline{\text{WE}}$  HIGH, the output remains in a high-impedance state.
- 19. During this period, the I/Os are in output state and input signals should not be applied.

**Switching Waveforms** (continued)

**Write Cycle No. 3 ( $\overline{\text{WE}}$  Controlled,  $\overline{\text{OE}}$  LOW)<sup>[13, 18]</sup>**

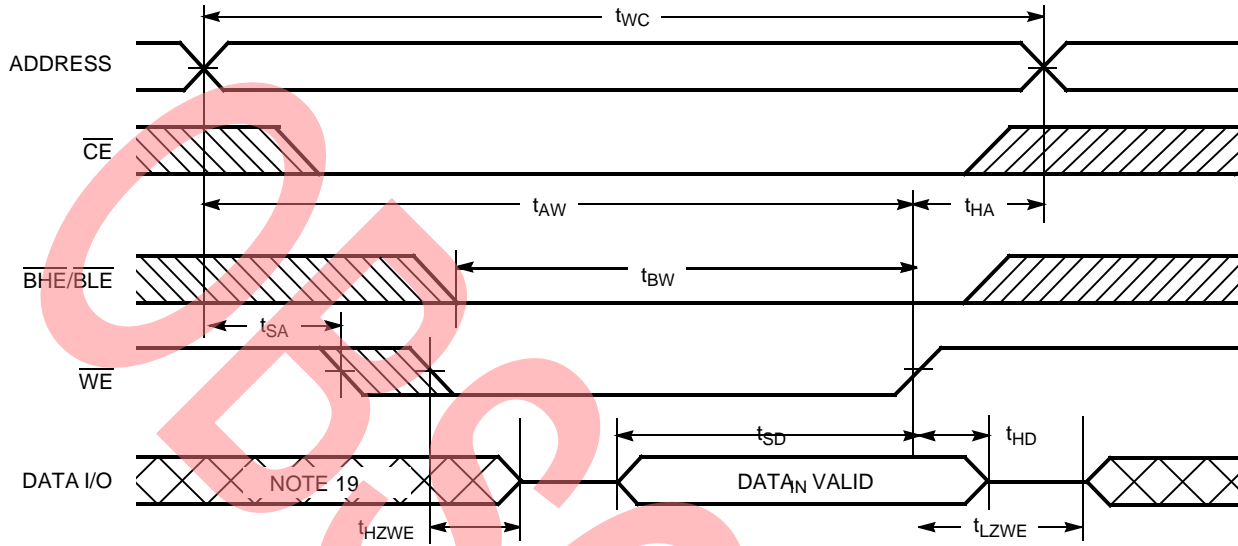

**Write Cycle No. 4 ( $\overline{\text{BHE/BLE}}$  Controlled,  $\overline{\text{OE}}$  LOW)<sup>[19]</sup>**

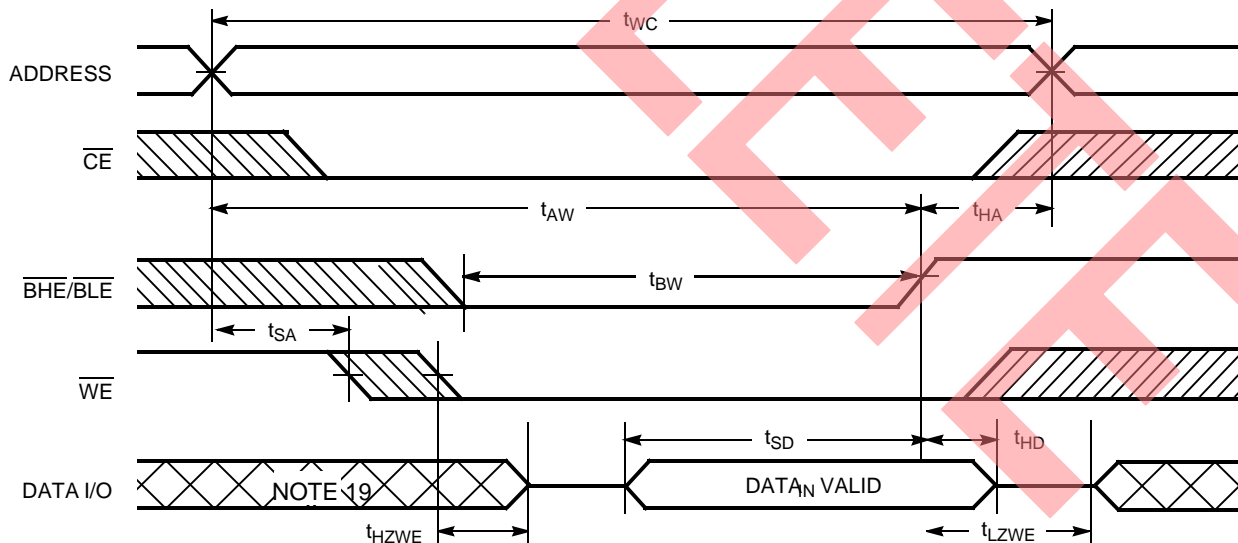

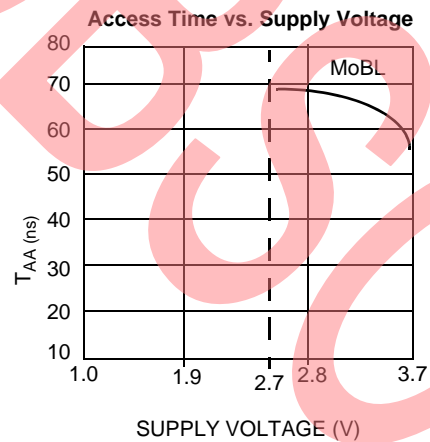
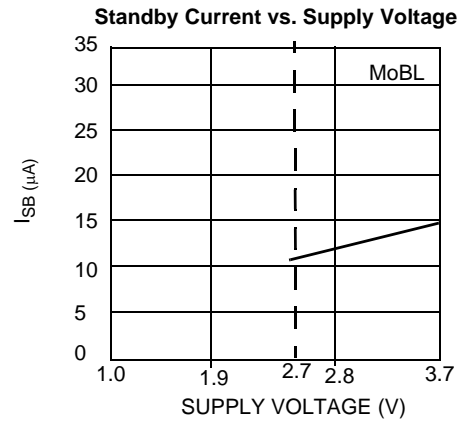
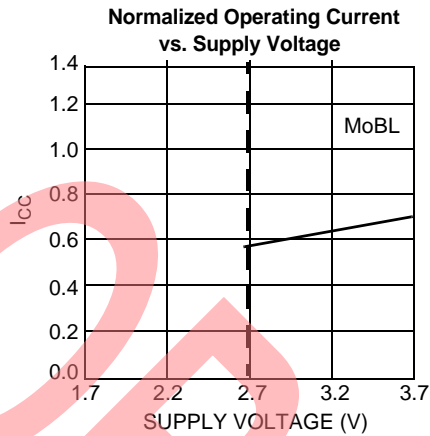
**Typical DC and AC Characteristics**

**Truth Table**

$\overline{CE}$	$\overline{WE}$	$\overline{OE}$	$\overline{BHE}$	$\overline{BLE}$	Inputs/Outputs	Mode	Power
H	X	X	X	X	High-Z	Deselect/Power-down	Standby ( $I_{SB}$ )
L	H	L	L	L	Data Out ( $I/O_0$ – $I/O_{15}$ )	Read	Active ( $I_{CC}$ )
L	H	L	H	L	High Z ( $I/O_8$ – $I/O_{15}$ ); Data Out ( $I/O_0$ – $I/O_7$ )	Read	Active ( $I_{CC}$ )
L	H	L	L	H	Data Out ( $I/O_8$ – $I/O_{15}$ ); High Z ( $I/O_0$ – $I/O_7$ )	Read	Active ( $I_{CC}$ )
L	L	X	L	L	Data In ( $I/O_0$ – $I/O_{15}$ )	Write	Active ( $I_{CC}$ )
L	L	X	H	L	High Z ( $I/O_8$ – $I/O_{15}$ ); Data In ( $I/O_0$ – $I/O_7$ )	Write	Active ( $I_{CC}$ )
L	L	X	L	H	Data in ( $I/O_8$ – $I/O_{15}$ ); High Z ( $I/O_0$ – $I/O_7$ )	Write	Active ( $I_{CC}$ )
L	H	L	H	H	High-Z	Deselect/Output Disabled	Active ( $I_{CC}$ )
L	H	H	L	L	High-Z	Deselect/Output Disabled	Active ( $I_{CC}$ )
L	H	H	H	L	High-Z	Deselect/Output Disabled	Active ( $I_{CC}$ )
L	H	H	L	H	High-Z	Deselect/Output Disabled	Active ( $I_{CC}$ )

Ordering Information

Speed (ns)	Ordering Code	Package Diagram	Package Type	Operating Range
55	CY62136VLL-55BAI	51-85096	48-ball Fine-Pitch Ball Grid Array (7 x 7 x 1.2 mm)	Industrial
	CY62136VLL-55ZI	51-85087	44-pin TSOP II	
	CY62136VLL-55ZXI		44-pin TSOP II (Pb-free)	
70	CY62136VLL-70BAI	51-85096	48-ball Fine-Pitch Ball Grid Array (7 x 7 x 1.2 mm)	Industrial
	CY62136VLL-70ZI	51-85087	44-pin TSOP II	
	CY62136VLL-70ZXI		44-pin TSOP II (Pb-free)	
	CY62136VLL-70ZSE		44-pin TSOP II	Automotive
	CY62136VLL-70ZSXE		44-pin TSOP II (Pb-free)	

Please contact your local Cypress sales representative for availability of these parts

Package Diagrams

48-ball FBGA (7 x 7 x 1.2 mm) (51-85096)

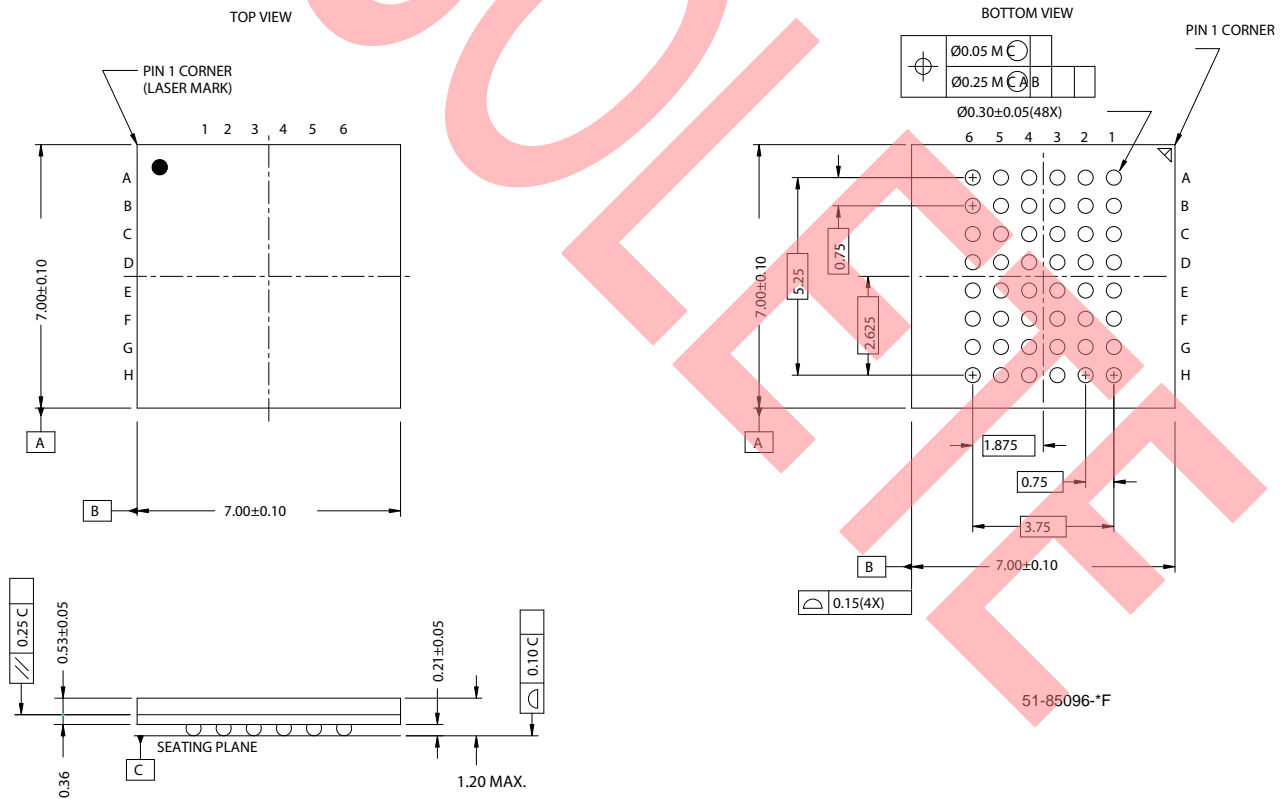

Package Diagrams (continued)

44-pin TSOP II (51-85087)

DIMENSION IN MM (INCH)  
MAX  
MIN.

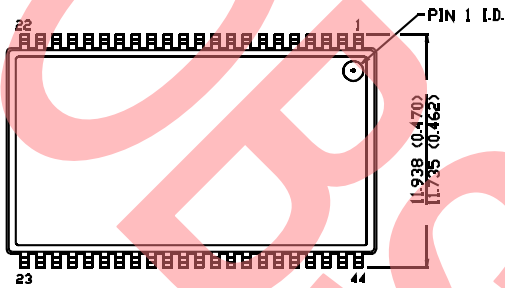

TOP VIEW

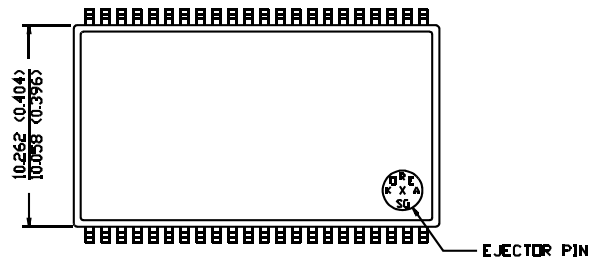

BOTTOM VIEW

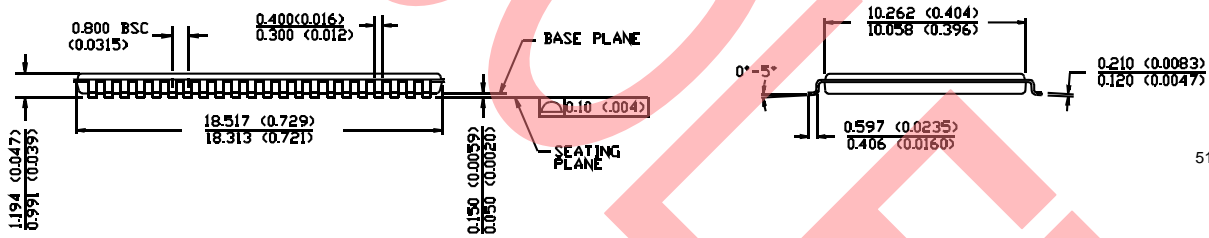

51-85087-A

MoBL is a registered trademark, and More Battery Life is a trademark, of Cypress Semiconductor Corporation. All product and company names mentioned in this document are the products of their respective holders.

**Document History Page**

Document Title: CY62136V MoBL® 2-Mbit (128K x 16) Static RAM				
Document Number: 38-05087				
REV.	ECN NO.	Issue Date	Orig. of Change	Description of Change
**	107347	05/25/01	SZV	Changed from Spec #: 38-00728 to 38-05087
*A	116509	09/04/02	GBI	Added footnote 1 Added SL power bin Deleted fBGA package; replacement fBGA package available in CY62136CV30
*B	269729	See ECN	SYT	Added Automotive Information for 70-ns Speed Bin. Added Footnotes # 3 and # 6. Corrected Typo in Electrical Characteristics for I <sub>CC</sub> (Max)-55 ns from 15 to 20 mA. Added SL row for I <sub>SB2</sub> in the Electrical Characteristics table. Changed Package Name from Z44 to ZS44. Replaced 'Z' with 'ZS' in the Ordering Code.
*C	344595	See ECN	SYT	Added Lead-Free Package on page# 9 Changed Package Name from ZS44 to Z44 for the 44 TSOP II Package Replaced 'ZS' with 'Z' in the Ordering Code for Industrial
*D	486789	See ECN	VKN	Changed address of Cypress Semiconductor Corporation on Page# 1 from "3901 North First Street" to "198 Champion Court". Added FBGA Package for Industrial Operating range. Removed SL Power bin. Updated Ordering Information table.
*E	2894060	03/17/2010	AJU	Obsolete data sheet - inactive parts