

# HSMS-8101, 8202, 8207, 8209

## Surface Mount Microwave Schottky Mixer Diodes



### Data Sheet

#### Description/Applications

These low cost microwave Schottky diodes are specifically designed for use at X/Ku-bands and are ideal for DBS and VSAT downconverter applications. They are available in SOT-23 and SOT-143 standard package configurations.

Note that Avago's manufacturing techniques assure that dice found in pairs and quads are taken from adjacent sites on the wafer, assuring the highest degree of match.

#### Features

- Optimized for use at 10-14 GHz
- Low Capacitance
- Low Conversion Loss
- Low RD
- Low Cost Surface Mount Plastic Package
- Lead-free Option Available

#### Plastic SOT-23 Package

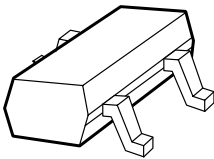

#### Plastic SOT-143 Package

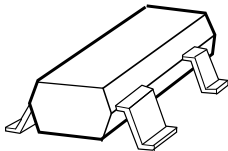

#### Package Lead Code Identification (Top View)

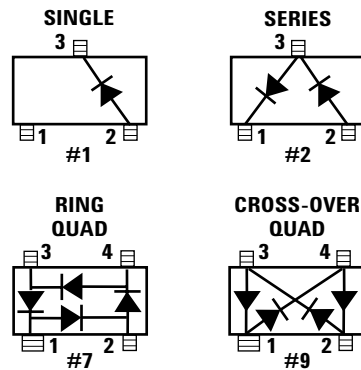

#### Absolute Maximum Ratings<sup>[1]</sup>, T<sub>A</sub> = +25°C

Symbol	Parameter	Unit	Min.	Max.
P <sub>T</sub>	Total Device Dissipation <sup>[2]</sup>	mW	—	75
P <sub>IV</sub>	Peak Inverse Voltage	V	—	4
T <sub>J</sub>	Junction Temperature	°C	—	+150
T <sub>STG</sub> , T <sub>op</sub>	Storage and Operating Temperature	°C	-65	+150

#### Notes:

1. Operation in excess of any one of these conditions may result in permanent damage to the device.
2. Measured in an infinite heat sink at T<sub>CASE</sub> = 25°C. Derate linearly to zero at 150°C per diode.



**Attention:**  
Observe precautions for handling electrostatic sensitive devices.

ESD Machine Model (Class A)

ESD Human Body Model (Class 0)

Refer to Avago Application Note A004R: Electrostatic Discharge Damage and Control.

**DC Electrical Specifications,  $T_A = 25^\circ\text{C}$** 

Symbol	Parameters and Test Conditions	Units	HSMS-8101		HSMS-8202		HSMS-8207		HSMS-8209	
			Min.	Max.	Min.	Max.	Min.	Max.	Min.	Max.
$V_{BR}$	Breakdown Voltage $I_R = 10 \mu\text{A}$	V	4		4		4		4	
$C_T$	Total Capacitance $V_R = 0 \text{ V}, f = 1 \text{ MHz}$	pF		0.26		0.26		0.26		0.26
$DC_T$	Capacitance Difference $V_R = 0 \text{ V}, f = 1 \text{ MHz}$	pF		—		0.04		0.04		0.04
$R_D$	Dynamic Resistance $I_F = 5 \text{ mA}$	$\Omega$		14		14		14		14
$DR_D$	Dynamic Resistance Difference $I_F = 5 \text{ mA}$	$\Omega$		—		2		2		2
$V_F$	Forward Voltage $I_F = 1 \text{ mA}$	mV	250	350	250	350	250	350	250	350
$DV_F$	Forward Voltage Difference $I_F = 1 \text{ mA}$	mV		—		20		20		20
Lead Code			1		2		7		9	
Package Marking Code where x is date code			R1x		2Rx		R7x		R9x	

**RF Electrical Parameters,  $T_A = 25^\circ\text{C}$** 

Symbol	Parameter	Units	Typical
$L_c$	Conversion Loss at 12 GHz	dB	6.3
$Z_{IF}$	IF Impedance	$\Omega$	150
SWR	SWR at 12 GHz		1.2

**Note:**DC Load Resistance = 0  $\Omega$ ; LO Power = 1 mW.**SPICE Parameters**

$I_S = 4.6 \text{ E-}8$	$E_G = 0.69$	TT = 0
$R_S = 6$	$C_{JO} = 0.18 \text{ E-}12$	
$N = 1.09$	$P_B (V_J) = 0.5$	
$B_V = 7.3$	$M = 0.5$	
$I_{BV} = 10\text{E-}5$	$FC = 0.5$	

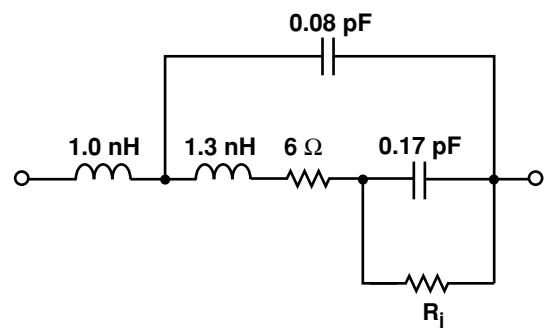
**Linear Equivalent Circuit****Self Bias**

	1 mA	2.5 mA
$R_j$	256	142

### Typical Performance, $T_c = 25^\circ\text{C}$

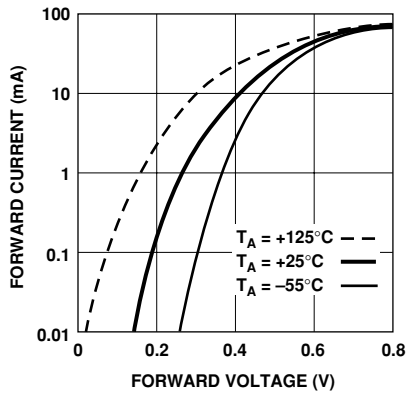

Figure 1. Typical Forward Current vs. Forward Voltage at Three Temperatures.

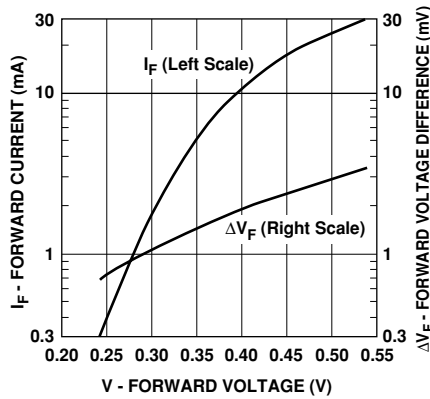

Figure 2. Typical VF Match, HSMS-820X Pairs and Quads.

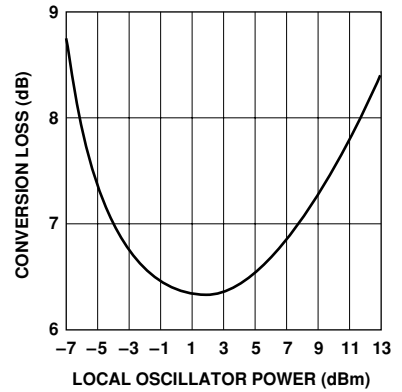
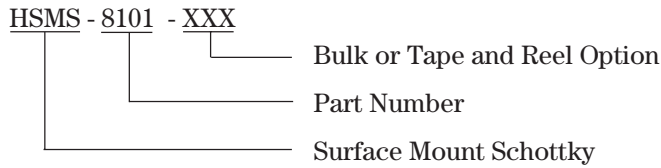

Figure 3. Typical Conversion Loss vs. Local Oscillator Power.

### Ordering Information

Specify part number followed by option. For example:



### Profile Option Descriptions

- BLK = Bulk
- TR1 = 3K pc. Tape and Reel, Device Orientation Figures 4, 5
- TR2 = 10K pc. Tape and Reel, Device Orientation Figures 4, 5

Tape and Reeling conforms to Electronic Industries RS-481, "Taping of Surface Mounted Components for Automated Placement."

For lead-free option, the part number will have the character "G" at the end, eg. -TR2G for a 10K pc lead-free reel.

### Device Orientation

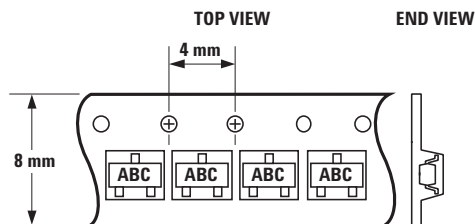
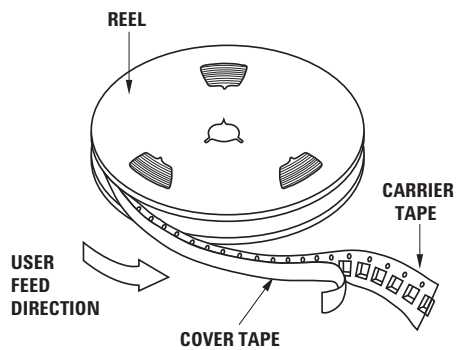

Note: "AB" represents package marking code.  
"C" represents date code.

Figure 4. Option -TR1/-TR2 for SOT-23 Packages.

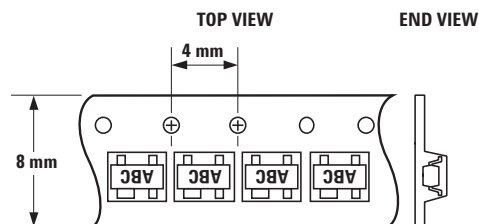

Note: "AB" represents package marking code.  
"C" represents date code.

Figure 5. Option -TR1/-TR2 for SOT-143 Packages.

### Package Characteristics

Lead Material ..... Alloy 42  
 Lead Finish..... Tin-Lead 85-15% (Non lead-free option)  
 or Tin 100% (Lead-free option)  
 Maximum Soldering Temperature ..... 260°C for 5 seconds  
 Minimum Lead Strength ..... 2 pounds pull  
 Typical Package Inductance ..... 2 nH  
 Typical Package Capacitance ..... 0.08 pF (opposite leads)

### Package Dimensions Outline 23 (SOT-23)

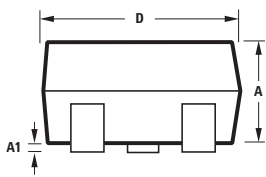
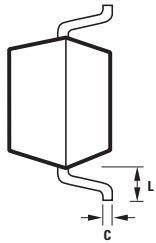
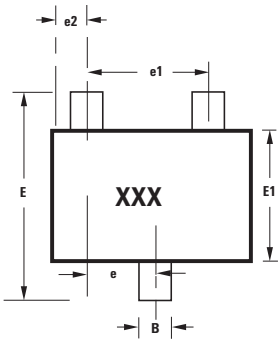

SYMBOL	DIMENSIONS (mm)	
	MIN.	MAX.
A	0.79	1.20
A1	0.000	0.100
B	0.37	0.54
C	0.086	0.152
D	2.73	3.13
E1	1.15	1.50
e	0.89	1.02
e1	1.78	2.04
e2	0.45	0.60
E	2.10	2.70
L	0.45	0.69

Notes:  
 XXX-package marking  
 Drawings are not to scale

### Recommended PCB Pad Layout for Avago's SOT-23 Products

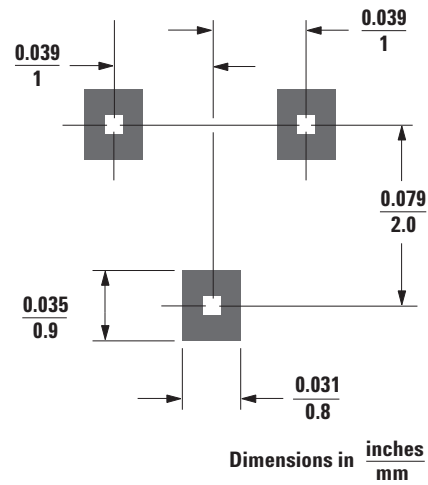

### Outline 143 (SOT-143)

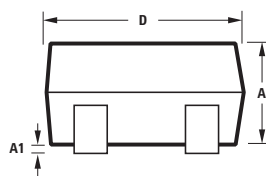
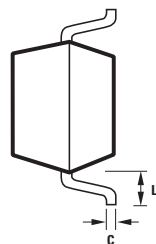
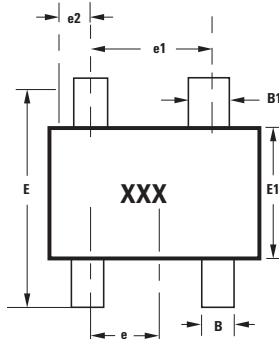

SYMBOL	DIMENSIONS (mm)	
	MIN.	MAX.
A	0.79	1.097
A1	0.013	0.10
B	0.36	0.54
B1	0.76	0.92
C	0.086	0.152
D	2.80	3.06
E1	1.20	1.40
e	0.89	1.02
e1	1.78	2.04
e2	0.45	0.60
E	2.10	2.65
L	0.45	0.69

Notes:  
 XXX-package marking  
 Drawings are not to scale

### Recommended PCB Pad Layout for Avago's SOT-143 Products

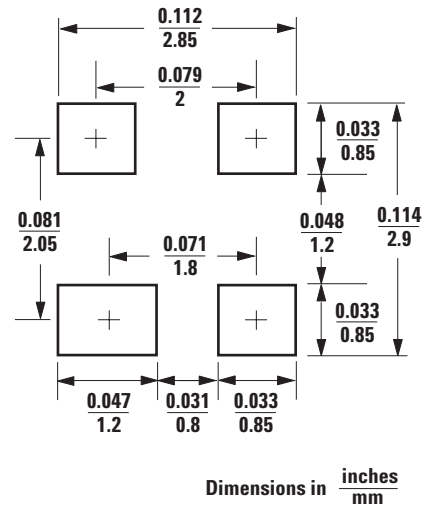

## Tape Dimensions and Product Orientation For Outline SOT-23

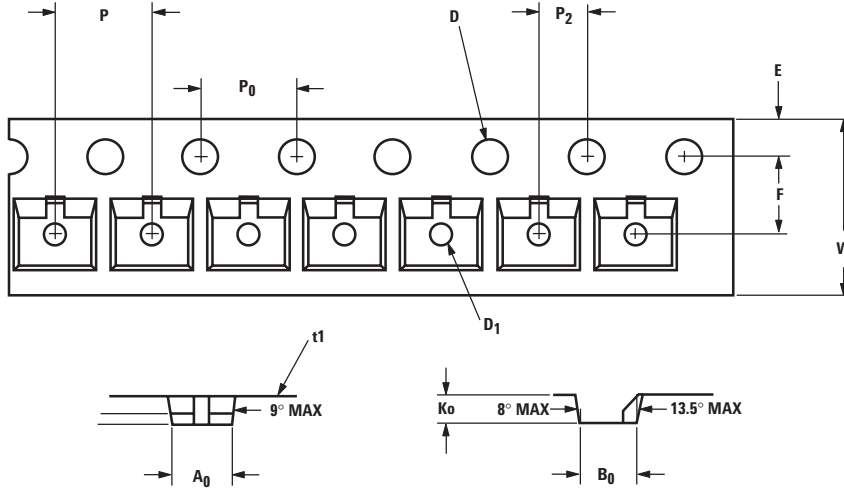

DESCRIPTION		SYMBOL	SIZE (mm)	SIZE (INCHES)
CAVITY	LENGTH	A <sub>0</sub>	3.15 ± 0.10	0.124 ± 0.004
	WIDTH	B <sub>0</sub>	2.77 ± 0.10	0.109 ± 0.004
	DEPTH	K <sub>0</sub>	1.22 ± 0.10	0.048 ± 0.004
	PITCH	P	4.00 ± 0.10	0.157 ± 0.004
	BOTTOM HOLE DIAMETER	D <sub>1</sub>	1.00 + 0.05	0.039 ± 0.002
PERFORATION	DIAMETER	D	1.50 ± 0.10	0.059 ± 0.004
	PITCH	P <sub>0</sub>	4.00 ± 0.10	0.157 ± 0.004
	POSITION	E	1.75 ± 0.10	0.069 ± 0.004
CARRIER TAPE	WIDTH	W	8.00 + 0.30 - 0.10	0.315 + 0.012 - 0.004
	THICKNESS	t <sub>1</sub>	0.229 ± 0.013	0.009 ± 0.0005
DISTANCE BETWEEN CENTERLINE	CAVITY TO PERFORATION (WIDTH DIRECTION)	F	3.50 ± 0.05	0.138 ± 0.002
	CAVITY TO PERFORATION (LENGTH DIRECTION)	P <sub>2</sub>	2.00 ± 0.05	0.079 ± 0.002

## Tape Dimensions and Product Orientation For Outline SOT-143

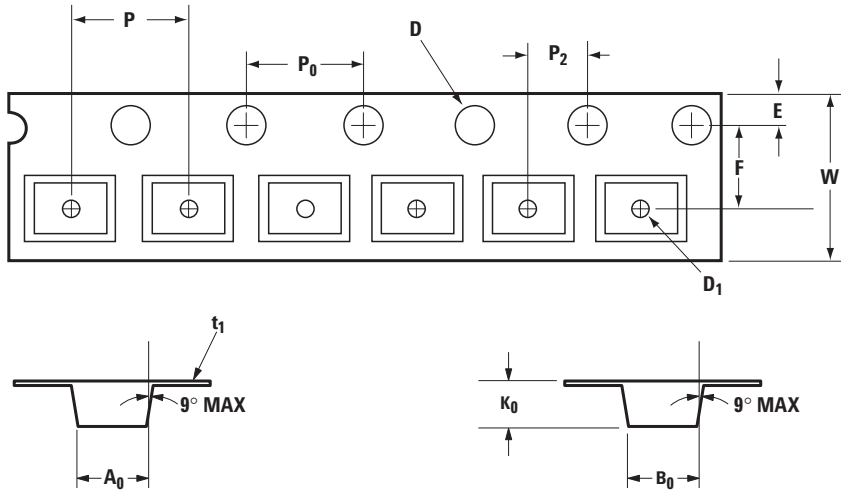

DESCRIPTION		SYMBOL	SIZE (mm)	SIZE (INCHES)
CAVITY	LENGTH	$A_0$	$3.19 \pm 0.10$	$0.126 \pm 0.004$
	WIDTH	$B_0$	$2.80 \pm 0.10$	$0.110 \pm 0.004$
	DEPTH	$K_0$	$1.31 \pm 0.10$	$0.052 \pm 0.004$
	PITCH	$P$	$4.00 \pm 0.10$	$0.157 \pm 0.004$
	BOTTOM HOLE DIAMETER	$D_1$	$1.00 + 0.25$	$0.039 + 0.010$
PERFORATION	DIAMETER	$D$	$1.50 + 0.10$	$0.059 + 0.004$
	PITCH	$P_0$	$4.00 \pm 0.10$	$0.157 \pm 0.004$
	POSITION	$E$	$1.75 \pm 0.10$	$0.069 \pm 0.004$
CARRIER TAPE	WIDTH	$W$	$8.00 + 0.30 - 0.10$	$0.315 + 0.012 - 0.004$
	THICKNESS	$t_1$	$0.254 \pm 0.013$	$0.0100 \pm 0.0005$
DISTANCE	CAVITY TO PERFORATION (WIDTH DIRECTION)	$F$	$3.50 \pm 0.05$	$0.138 \pm 0.002$
	CAVITY TO PERFORATION (LENGTH DIRECTION)	$P_2$	$2.00 \pm 0.05$	$0.079 \pm 0.002$

For product information and a complete list of distributors, please go to our web site:  
[www.avagotech.com](http://www.avagotech.com)

Avago, Avago Technologies, and the A logo are trademarks of Avago Technologies, Pte. in the United States and other countries.

Data subject to change. Copyright © 2006 Avago Technologies Pte. All rights reserved.  
Obsoletes 5989-2496EN  
5989-4024EN September 8, 2006

**AVAGO**  
TECHNOLOGIES